



DGN LIGHT
ADDICTED

CLASSIC
COLLECTION

INDOOR CLASSIC

DGA

100 ... 350 lm

INCASSI A MOLLE
FIXTURES WITH SPRINGS



GEMMA 18 m
page 9



GEMMA 40 m
page 10



GEMMA 40 Am
page 11



GEMMA 40 mR
page 15



GEMMA QD 40 m
page 17



ACROBAT
page 18



ACROBAT 360
page 19



STAR 3
page 22



STAR 3 R
page 23



STAR 3 Am
page 25



CIRCO 1
page 29



CIRCO 3
page 29

100 ... 350 lm

INCASSI CON GHIERA
FIXTURES WITH RING NUT



GEMMA 18 g
page 34



GEMMA 30 g
page 35



GEMMA 30 gR
page 36

100 ... 350 lm

INCASSI CON CASSAFORMA
FIXTURES WITH HOUSING

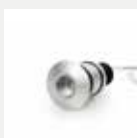

GEMMA 20 i
page 42

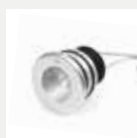

GEMMA 30 i
page 43



GEMMA 30 iR
page 45



GEMMA Qd 35 i
page 47



GEMMA 50 i
page 50

100 ... 150 lm

SEGNAPASSO
STEP LIGHTS



LUI
page 51



LEI
page 53

2300 ... 4000 lm



APPARECCHI A BINARIO E
APPLIQUE 230Vac
230Vac TRACK FIXTURES
AND APPLIQUES



EMPORIO B+
page 57



EMPORIO PL+
page 64



WALL
WASHER
EMPORIO B
WALL WASHER
page 61



EMPORIO PL
WALL WASHER
page 65



LINEA 8°
8° BEAM
ANGLE
EOS B 8°
page 62

100 ... 150 lm

FLESSIBILI
FLEX



READING LIGHT
FLEX
page 66



READING LIGHT
FLEX P
page 67

CLASSIC COLLECTION



OUTDOOR CLASSIC

DGA

INCASSI A MOLLE
FIXTURES WITH SPRINGS

100 ... 300 lm



GEMMA 20 IP67 m
page 72



GEMMA 35
IP67 m
page 73



GEMMA Qd 35
IP67 m
page 75



ARCO 60 m
page 79

INCASSI CON CASSAFORMA
FIXTURES WITH HOUSING

100 ... 450 lm

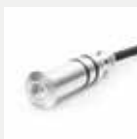

GEMMA 20 IP67
page 85



GEMMA 35 IP67
page 86



GEMMA Qd 35
IP67
page 87



ASTRO 80
page 88



ASTRO Qd 80
page 89



ARCO 60 i
page 91



NESIS H65
page 92

600 ... 1400 lm



AURA 6-8
page 94



AURA 12
page 97

INCASSI ORIENTABILI
ADJUSTABLE FIXTURES

300 ... 700 lm



GIOVE 3S R
page 100



GIOVE 7S R
page 101

600 ... 1500 lm



GEO 6-8 R
page 104



GEO 12 R
page 105

SEGNAPASSO CON CASSAFORMA
STEP LIGHT WITH HOUSING

100 ... 400 lm



LUI IP65
page 111



LEI IP65
page 113



RIDI
page 117



ARCO 50 iL
page 119

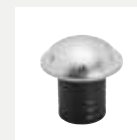

DISCOVERY
page 121

INCASSI CON CASSAFORMA
IP68
FIXTURES WITH HOUSING

100 ... 1050 lm



GEMMA 20 IP68
page 127



GEMMA 35 IP68
page 128



ARCO 60 IP68
page 131



NESIS H65 IP68
page 133



ARCO 80 IP68
page 134



IRIDE 3 IP68 i
page 136

PROIETTORI ORIENTABILI
ADJUSTABLE SPOTLIGHTS

300 lm



MICRO
page 140

1500 ... 2000 lm



QUANTUM P
page 145

600 ... 2000 lm



SIRIO 6 Evo
page 149



SIRIO 9 Evo
page 150



SIRIO 12 Evo
page 151



SIRIO 20 Evo
page 153

PALETTI
BOLLARDS

600 ... 1900 lm

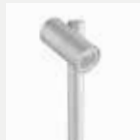

EDEN 6-8
page 158



EDEN 12-18
page 159

PROIETTORI SCENOGRAFICI
RGBW - DMX
FLOODLIGHTS



IRIDE 3 i
page 164



IRIDE 3 P
page 165



IRIDE 9
page 167



IRIDE 15
page 169

APPLIQUE A PARETE
WALL MOUNTING APPLIQUES

100 ... 400 lm



ZENITH
page 174



ZENITH DUO
page 175



ORION EVO
page 176



QUARK EVO
page 180

2000 lm



COMETA LC
page 184

PROIETTORI ORIENTABILI
IP68
ADJUSTABLE SPOTLIGHTS

300 lm



IRIDE 3 IP68 P
page 137



MICRO IP68
page 141

DRIVER & ACCESSORI
DRIVER & ACCESSORIES

DGN

IN DOOR 2017



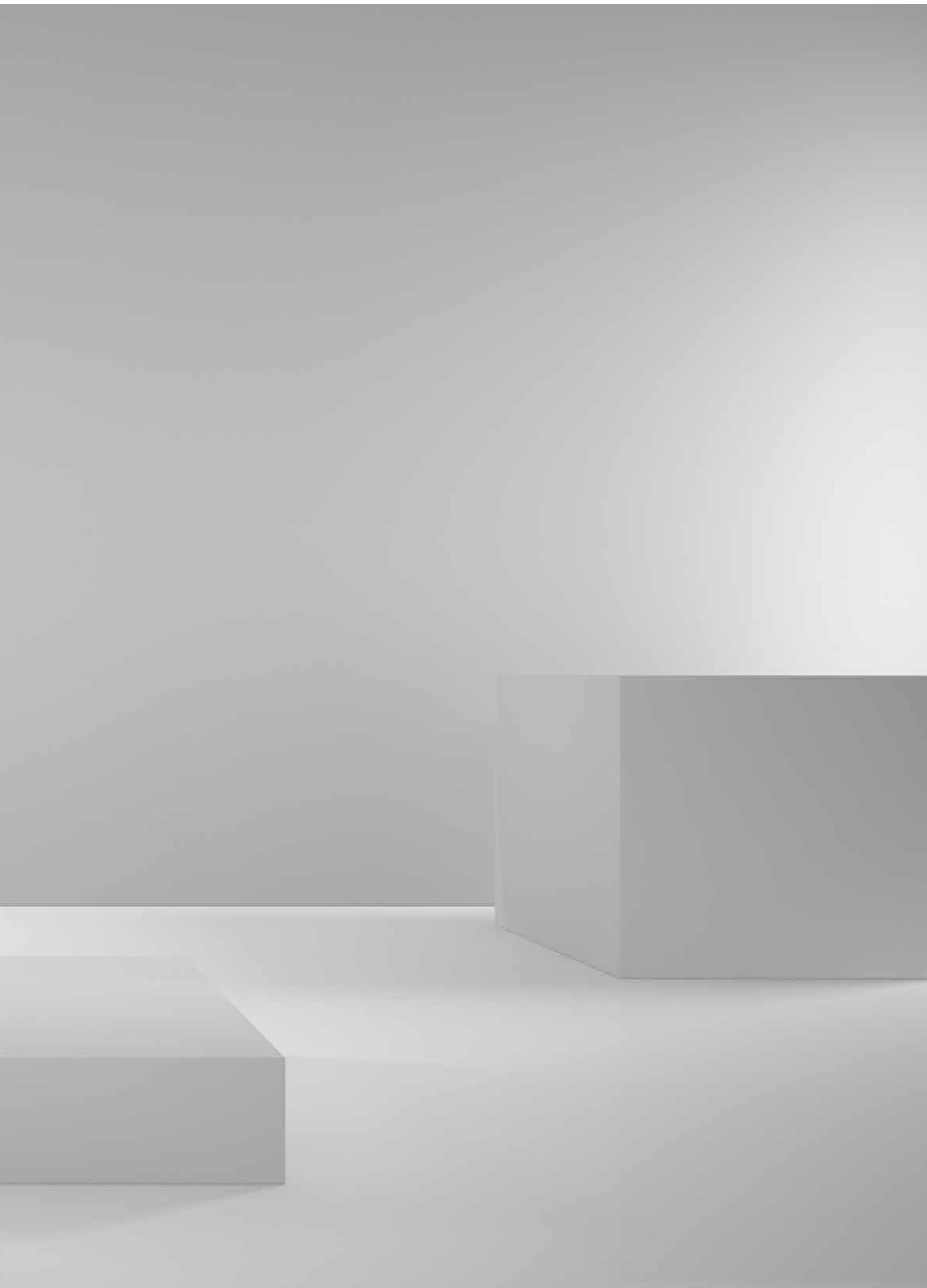



INCASSI A MOLLE

FIXTURES WITH SPRINGS

100 ... 350 lm



GEMMA 18 m
page 9



GEMMA 40 m
page 10



GEMMA 40 Am
page 11



GEMMA 40 mR
page 15



GEMMA Qd 40 m
page 17



ACROBAT
page 18



ACROBAT 360
page 19



STAR 3
page 22



STAR 3 R
page 23



STAR 3 Am
page 25



CIRCO 1
page 29



CIRCO 3
page 29





IP52

Class III

Incasso a parete, soffitto
Wall, ceiling recessed

Cavo 60 cm con connettore rapido
60 cm cable with quick connector

Collegare in serie 350mA
Connect in series at 350mA

20 gr

Ø 13 mm

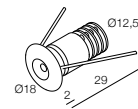

GEMMA 18 m









	1W 350mA	Finiture Finish	Colore LED LED Colour
Lumen 3000K	100lm		
40° Lens	740108._ _	1 Cromo lucido Shiny chrome	Y 2700K
		3 Grigio - Gray	6 3000K
130° Emission	700108._ _	4 Nero - Black	W 3000K CRI > 90
		7 Bianco - White	9 4000K
			1 5000K

LED COLOUR
FINISH

ALIMENTATORI CONSIGLIATI (non inclusi)
SUGGESTED DRIVERS (not included)







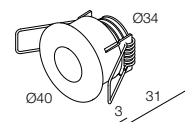





350mA CC20-F-350-N

pag. 190

-  IP52
-  Class III
-  Incasso a parete, soffitto
Wall, ceiling recessed
-  Possibilità di scelta tra 6 differenti ottiche
Available in 6 different optics
-  Cavo 60 cm con connettore rapido
60 cm cable with quick connector
-  Collegare in serie 350mA o 500mA
Connect in series at 350mA or 500mA
-  50 gr
-  Ø 35 mm
-  Controcassa per cemento e muratura
Recessed Box for concrete and brickwork page 202











GEMMA 40 m

	1W 350mA	2W 500mA	3W 350mA	3W RGB 350mA	Finiture Finish	Colore LED LED Colour
Lumen 3000K	100lm	150lm	300lm	350lm		
 10° Lens	730110._ _	730111._ _			 1 Cromo lucido Shiny chrome	 Y 2700K
 30° Lens	760110._ _	760111._ _		760612._ 7	 3 Grigio - Gray	 6 3000K
 60° Lens	750110._ _	750111._ _	750112._ _		 4 Nero - Black	 W 3000K CRI > 90
 Vetro trasparente Transparent glass	720110._ _	720111._ _	720112._ _			 9 4000K
 Vetro satinato Frosted glass	710110._ _	710111._ _	710112._ _	710612._ 7		 1 5000K

LED COLOUR
FINISH







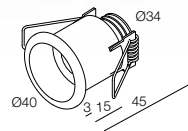





ALIMENTATORI CONSIGLIATI (non inclusi)
SUGGESTED DRIVERS (not included)

350mA	CC20-F-350-N	pag. 190
500mA	CC20-F-500-N	pag. 192
350mA RGB	CC36-X-350-N	pag. 200

-  IP52
-  Class III
-  Incasso a parete, soffitto
Wall, ceiling recessed
-  Possibilità di scelta tra 5 differenti ottiche
Available in 5 different optics
-  Cavo 60 cm con connettore rapido
60 cm cable with quick connector
-  Collegare in serie 350mA o 500mA
Connect in series at 350mA or 500mA
-  60 gr
-  Ø 35 mm
-  Controcassa per cemento e muratura
Recessed Box for concrete and brickwork page 202



GEMMA 40 Am

	1W 350mA	2W 500mA	3W 350mA	3W RGB 350mA	Finiture Finish	Colore LED LED Colour
Lumen 3000K	100lm	150lm	300lm	350lm		
 10° Lens	730334._ _	730335._ _			 3 Grigio - Gray	 Y 2700K
 30° Lens	760334._ _	760335._ _		760613._ 7	 4 Nero - Black	 6 3000K
 60° Lens	750334._ _	750335._ _	750336._ _		 7 Bianco - White	 W 3000K CRI > 90
 Vetro trasparente Transparent glass	720334._ _	720335._ _	720336._ _			 9 4000K
 Vetro satinato Frosted glass	710334._ _	710335._ _	710336._ _	710613._ 7		 1 5000K

LED COLOUR
FINISH

ALIMENTATORI CONSIGLIATI (non inclusi)
SUGGESTED DRIVERS (not included)

350mA CC20-F-350-N pag. 190
500mA CC20-F-500-N pag. 192
350mA RGB CC36-X-350-N pag. 200



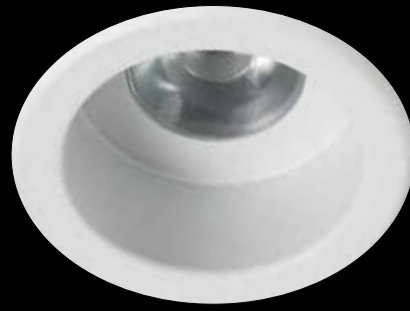

DGA

**ECO
ENERGY
SAVING**

DGA

INTERNO
INDOOR



GEMMA 40 mR

Elevata precisione cromatica









High chromatic precision



Orientabile + - 25°































Adjustable + - 25°



-  IP52
-  Class III
-  Incasso a parete, soffitto
Wall, ceiling recessed
-  Possibilità di scelta tra 7 differenti ottiche
Available in 7 different optics
-  Cavo 60 cm con connettore rapido
60 cm cable with quick connector
-  Collegare in serie 350mA o 500mA
Connect in series at 350mA or 500mA
-  50 gr
-  Ø 35 mm
-  Controcassa per cemento e muratura
Recessed Box for concrete and brickwork page 202



GEMMA 40 mR

	1W 350mA	2W 500mA	Finiture Finish	Colore LED LED Colour
Lumen 3000K	100lm	150lm		
 10° Lens	730120._ _	730121._ _	<ul style="list-style-type: none">  1 Cromo lucido Shiny chrome  3 Grigio - Gray  4 Nero - Black 	<ul style="list-style-type: none">  Y 2700K  6 3000K  W 3000K CRI > 90  9 4000K  1 5000K
 30° Lens	760120._ _	760121._ _		
 60° Lens	750120._ _	750121._ _		
 Vetro trasparente Transparent glass	720120._ _	720121._ _		
 Vetro satinato Frosted glass	710120._ _	710121._ _		
 40° Lens	740120._ _	740121._ _	<ul style="list-style-type: none">  1 Cromo lucido Shiny chrome  3 Grigio - Gray  4 Nero - Black 	<ul style="list-style-type: none">  Y 2700K  6 3000K  W 3000K CRI > 90  9 4000K  1 5000K
 130° Emission	700120._ _	700121._ _	<ul style="list-style-type: none">  1 Cromo lucido Shiny chrome  3 Grigio - Gray  4 Nero - Black 	<ul style="list-style-type: none">  Y 2700K  6 3000K  W 3000K CRI > 90  9 4000K  1 5000K

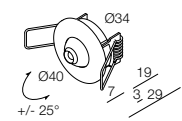
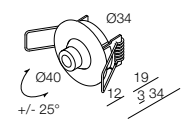
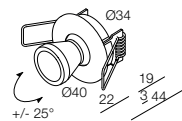

LED COLOUR
FINISH

ALIMENTATORI CONSIGLIATI (non inclusi)
SUGGESTED DRIVERS (not included)

350mA **CC20-F-350-N** pag. 190
500mA **CC20-F-500-N** pag. 192

GEMMA Qd 40

Sistema di dissipazione brevettato









Patented heat dissipation system



Modulo LED sostituibile







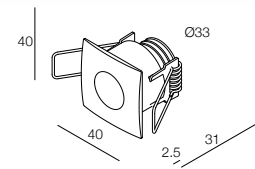







Replaceable LED module



-  IP52
-  Class III
-  Incasso a parete, soffitto
Wall, ceiling recessed
-  Possibilità di scelta tra 6 differenti ottiche
Available in 6 different optics
-  Cavo 60 cm con connettore rapido
60 cm cable with quick connector
-  Collegare in serie 350mA o 500mA
Connect in series at 350mA or 500mA
-  50 gr
-  Ø 34 mm
-  Controcassa per cemento e muratura
Recessed Box for concrete and brickwork page 202



GEMMA Qd 40 m

	1W 350mA	2W 500mA	3W 350mA	3W RGB 350mA	Finiture Finish	Colore LED LED Colour
Lumen 3000K	100lm	150lm	300lm	350lm		
 10° Lens	733334._ _	733335._ _			<ul style="list-style-type: none">  1 Cromo lucido Shiny chrome  3 Grigio - Gray  4 Nero - Black 	<ul style="list-style-type: none">  Y 2700K  6 3000K  W 3000K CRI > 90  9 4000K  1 5000K
 30° Lens	763334._ _	763335._ _		763336._ 7		
 60° Lens	753334._ _	753335._ _	753336._ _			
 Vetro trasparente Transparent glass	723334._ _	723335._ _	723336._ _			
 Vetro satinato Frosted glass	713334._ _	713335._ _	713336._ _	713336._ 7		
 Lente ellittica Elliptical lens	773334._ _	773335._ _				
	LED COLOUR					
	FINISH					

ALIMENTATORI CONSIGLIATI (non inclusi)
SUGGESTED DRIVERS (not included)



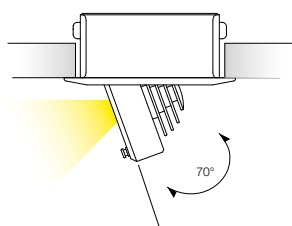





350mA CC20-F-350-N pag. 190
500mA CC20-F-500-N pag. 192
350mA RGB CC36-X-350-N pag. 200



Basculante 70°

70° tilting



-  IP40
-  Class III
-  Incasso a parete, soffitto
Wall, ceiling recessed
-  Cavo 60 cm con connettore rapido
60 cm cable with quick connector
-  Collegare in serie 350mA
Connect in series at 350mA
-  90 gr
-  Ø 52 mm
-  Controcassa per cemento e muratura
Recessed Box for concrete and brickwork page 202



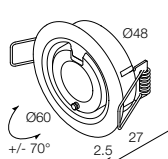



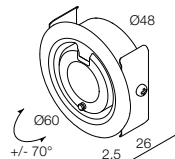





ACROBAT



CON MOLLE
WITH SPRINGS



CON MOLLE IN
ACCIAIO ARMONICO
WITH FLAT
LAMINATED SPRINGS

	3W 350mA	3W 350mA	Finiture Finish	Colore LED LED Colour
Lumen 3000K	300lm	300lm		
 15° Lens	7A0793._ _	7A0826._ _	 3 Grigio - Gray	 Y 2700K
 30° Lens	760793._ _	760826._ _	 4 Nero - Black	 6 3000K
 60° Lens	750793._ _	750826._ _	 7 Bianco - White	 W 3000K CRI > 90
 Lente ellittica Elliptical lens	770793._ _	770826._ _		 9 4000K
				 1 5000K

LED COLOUR
FINISH

ALIMENTATORI CONSIGLIATI (non inclusi)
SUGGESTED DRIVERS (not included)

350mA CC20-F-350-N

pag. 190

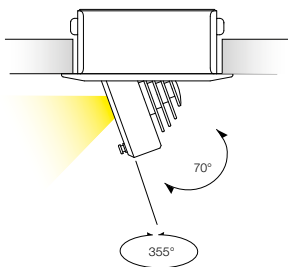

Basculante 70°
Orientabile 355°

70° tilting
355° adjustable



IP40

Class III

Incasto a parete, soffitto
Wall, ceiling recessed

Cavo 60 cm con connettore rapido
60 cm cable with quick connector

Collegare in serie 350mA
Connect in series at 350mA

90 gr

Ø 52 mm

Controcassa per cemento e muratura
Recessed Box for concrete and brickwork page 202

ACROBAT 360

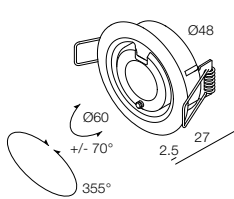

CON MOLLE
WITH SPRINGS

3W
350mA

Lumen 3000K

300lm

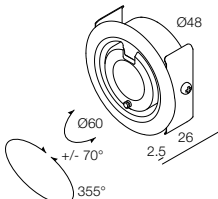

CON MOLLE IN
ACCIAIO ARMONICO
WITH FLAT
LAMINATED SPRINGS

3W
350mA

300lm

Finiture
Finish

Colore LED
LED Colour

	CON MOLLE WITH SPRINGS	CON MOLLE IN ACCIAIO ARMONICO WITH FLAT LAMINATED SPRINGS	Finiture Finish	Colore LED LED Colour
15° Lens	7A0795._ _	7A0827._ _	3 Grigio - Gray	Y 2700K
30° Lens	760795._ _	760827._ _	4 Nero - Black	6 3000K
60° Lens	750795._ _	750827._ _	7 Bianco - White	W 3000K CRI > 90
Lente ellittica Elliptical lens	770795._ _	770827._ _		9 4000K
				1 5000K

LED COLOUR
FINISH

ALIMENTATORI CONSIGLIATI (non inclusi)
SUGGESTED DRIVERS (not included)

350mA CC20-F-350-N









pag. 190



ACROBAT 360
ORIENTATO A OGNI PROGETTO
PROJECT-ORIENTED





-  IP40
-  Class III
-  Incasso a parete, soffitto
Wall, ceiling recessed
-  Cavo 60 cm con connettore rapido
60 cm cable with quick connector
-  Collegare in serie 350mA
Connect in series at 350mA
-  60 gr
-  Ø 44 mm
-  Controcassa per cemento e muratura
Recessed Box for concrete and brickwork page 202

STAR 3

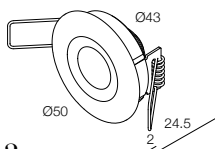

CON MOLLE
WITH SPRINGS

3W
350mA

Lumen 3000K

300lm

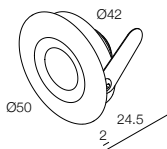

CON MOLLE IN
ACCIAIO ARMONICO
WITH FLAT
LAMINATED SPRINGS

3W
350mA

300lm

Finiture
Finish

Colore LED
LED Colour



15° Lens

7A0794._ _

7A0825._ _

 3 Grigio - Gray

 Y 2700K



30° Lens

760794._ _

760825._ _

 4 Nero - Black

 6 3000K



60° Lens

750794._ _

750825._ _

 7 Bianco - White

 W 3000K CRI > 90



Lente ellittica
Elliptical lens

770794._ _

770825._ _

 9 4000K

 1 5000K

LED COLOUR
FINISH

ALIMENTATORI CONSIGLIATI (non inclusi)
SUGGESTED DRIVERS (not included)

350mA CC20-F-350-N

pag. 190



 IP40

 Class III

 Incasso a parete, soffitto
Wall, ceiling recessed

 Cavo 60 cm con connettore rapido
60 cm cable with quick connector

 Collegare in serie 350mA
Connect in series at 350mA







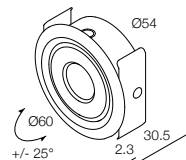





 60 gr

 Ø 54 mm

 Controcassa per cemento e muratura
Recessed Box for concrete and brickwork page 202



STAR 3 R

Lumen 3000K	3W 350mA	Finiture Finish	Colore LED LED Colour
 15° Lens	7A3547._ _	 3 Grigio - Gray	 Y 2700K
 30° Lens	763547._ _	 4 Nero - Black	 6 3000K
 60° Lens	753547._ _	 7 Bianco - White	 W 3000K CRI > 90
 Lente ellittica Elliptical lens	773547._ _		 9 4000K
			 1 5000K

LED COLOUR	
FINISH	

ALIMENTATORI CONSIGLIATI (non inclusi)
SUGGESTED DRIVERS (not included)

350mA CC20-F-350-N

pag. 190

STAR 3 Am

Elevata precisione cromatica

High chromatic precision



Sistema antiabbagliamento

Ensured by a low glare system





IP40 / IP55

Class III

Incasso a parete, soffitto
Wall, ceiling recessed

Cavo 60 cm con connettore rapido
60 cm cable with quick connector

Collegare in serie 350mA
Connect in series at 350mA

60 gr

Ø 44 mm

Controcassa per cemento e muratura
Recessed Box for concrete and brickwork page 202

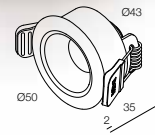

STAR 3 Am IP40

IP40	3W 350mA	Finiture Finish	Colore LED LED Colour
Lumen 3000K	300lm		
15° Lens	7A3130._ _	<input type="checkbox"/> 3 Grigio - Gray <input type="checkbox"/> 4 Nero - Black <input type="checkbox"/> 7 Bianco - White	<input type="checkbox"/> Y 2700K <input type="checkbox"/> 6 3000K <input type="checkbox"/> W 3000K CRI > 90 <input type="checkbox"/> 9 4000K <input type="checkbox"/> 1 5000K
30° Lens	763130._ _		
60° Lens	753130._ _		
Lente ellittica Elliptical lens	773130._ _		
		LED COLOUR	
		FINISH	

STAR 3 Am IP55

IP55	3W 350mA	Finiture Finish	Colore LED LED Colour
Lumen 3000K	300lm		
15° Lens	7A3719._ _	<input type="checkbox"/> 3 Grigio - Gray <input type="checkbox"/> 4 Nero - Black <input type="checkbox"/> 7 Bianco - White	<input type="checkbox"/> Y 2700K <input type="checkbox"/> 6 3000K <input type="checkbox"/> W 3000K CRI > 90 <input type="checkbox"/> 9 4000K <input type="checkbox"/> 1 5000K
30° Lens	763719._ _		
60° Lens	753719._ _		
Lente ellittica Elliptical lens	773719._ _		
		LED COLOUR	
		FINISH	

ALIMENTATORI CONSIGLIATI (non inclusi)
SUGGESTED DRIVERS (not included)

350mA CC20-F-350-N

pag. 190



STAR 3 Am
IL LUSO ACCESSIBILE
AFFORDABLE LUXURY





Sistema antiabbagliamento

Ensured by a low glare system



-  IP40
-  Class III
-  Incasso a parete, soffitto
Wall, ceiling recessed
-  Cavo 60 cm con connettore rapido
60 cm cable with quick connector
-  Collegare in serie 350mA
Connect in series at 350mA
-  50 gr CIRCO 1
-  65 gr CIRCO 3
-  Ø 40 mm CIRCO 1
-  Ø 45 mm CIRCO 3
-  Controcassa per cemento e muratura
Recessed Box for concrete and brickwork page 202

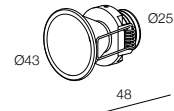





CIRCO 1

	1W 350mA	2W 500mA	Finiture Finish	Colore LED LED Colour
Lumen 3000K	100lm	150lm		
 40° Lens	743175.7 _	743176.7 _	<input type="checkbox"/> 7 Bianco - White	<input type="checkbox"/> Y 2700K <input type="checkbox"/> 6 3000K <input type="checkbox"/> W 3000K CRI > 90 <input type="checkbox"/> 9 4000K <input type="checkbox"/> 1 5000K

LED COLOUR
FINISH

CIRCO 3

	3W 350mA	Finiture Finish	Colore LED LED Colour
Lumen 3000K	300lm		
 15° Lens	7A3177.7 _	<input type="checkbox"/> 7 Bianco - White	<input type="checkbox"/> Y 2700K <input type="checkbox"/> 6 3000K <input type="checkbox"/> W 3000K CRI > 90 <input type="checkbox"/> 9 4000K <input type="checkbox"/> 1 5000K
 30° Lens	763177.7 _		
 60° Lens	753177.7 _		
 Lente ellittica Elliptical lens	773177.7 _		

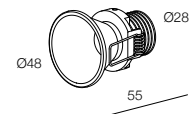

LED COLOUR
FINISH

ALIMENTATORI CONSIGLIATI (non inclusi)
SUGGESTED DRIVERS (not included)

350mA CC20-F-350-N pag. 190

DGA

INTERNO
INDOOR



DGA

ALTO INDICE DI
RESA CROMATICA
HIGH COLOR
RENDERING INDEX







INCASSI CON GHIERA

FIXTURES WITH RING NUT

100 ... 350 lm



GEMMA 18 g
page 34









GEMMA 30 g
page 35









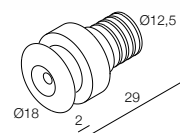



GEMMA 30 gR
page 36



-  IP52
-  Class III
-  Incasso a parete, soffitto
Wall, ceiling recessed
-  Cavo 60 cm con connettore rapido
60 cm cable with quick connector
-  Collegare in serie 350mA o 500mA
Connect in series at 350mA or 500mA
-  25 gr
-  Ø 13 mm











GEMMA 18 g

	1W 350mA	2W 500mA	Finiture Finish	Colore LED LED Colour
Lumen 3000K	100lm	150lm		
 40° Lens	740100._ _	740101._ _	<ul style="list-style-type: none">  1 Cromo lucido Shiny chrome  3 Grigio - Gray  4 Nero - Black  7 Bianco - White 	<ul style="list-style-type: none">  Y 2700K  6 3000K  W 3000K CRI > 90  9 4000K  1 5000K
 130° Emission	700100._ _	700101._ _		

LED COLOUR
FINISH







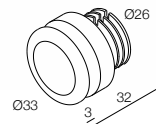





ALIMENTATORI CONSIGLIATI (non inclusi)
SUGGESTED DRIVERS (not included)

350mA **CC20-F-350-N** pag. 190
500mA **CC20-F-500-N** pag. 192

-  IP52
-  Class III
-  Incasso a parete, soffitto
Wall, ceiling recessed
-  Possibilità di scelta tra 5 differenti ottiche
Available in 5 different optics
-  Cavo 60 cm con connettore rapido
60 cm cable with quick connector
-  Collegare in serie 350mA o 500mA
Connect in series at 350mA or 500mA
-  30 gr
-  Ø 27 mm











GEMMA 30 g

	1W 350mA	2W 500mA	3W 350mA	3W RGB 350mA	Finiture Finish	Colore LED LED Colour
Lumen 3000K	100lm	150lm	300lm	350lm		
 10° Lens	730102._ _	730103._ _			<ul style="list-style-type: none">  1 Cromo lucido Shiny chrome  3 Grigio - Gray  4 Nero - Black 	<ul style="list-style-type: none">  Y 2700K  6 3000K  W 3000K CRI > 90  9 4000K  1 5000K
 30° Lens	760102._ _	760103._ _		760608._ 7		
 60° Lens	750102._ _	750103._ _	750104._ _			
 Vetro trasparente Transparent glass	720102._ _	720103._ _	720104._ _			
 Vetro satinato Frosted glass	710102._ _	710103._ _	710104._ _	710608._ 7		

LED COLOUR
FINISH































ALIMENTATORI CONSIGLIATI (non inclusi)
SUGGESTED DRIVERS (not included)

350mA CC20-F-350-N pag. 190
500mA CC20-F-500-N pag. 192
350mA RGB CC36-X-350-N pag. 200

-  IP52
-  Class III
-  Incasso a parete, soffitto
Wall, ceiling recessed
-  Possibilità di scelta tra 7 differenti ottiche
Available in 7 different optics
-  Cavo 60 cm con connettore rapido
60 cm cable with quick connector
-  Collegare in serie 350mA o 500mA
Connect in series at 350mA or 500mA
-  35 gr
-  Ø 27 mm



GEMMA 30 gR

	1W 350mA	2W 500mA	Finiture Finish	Colore LED LED Colour
Lumen 3000K	100lm	150lm		
 10° Lens	730116._ _	730117._ _	<ul style="list-style-type: none">  1 Cromo lucido Shiny chrome  3 Grigio - Gray  4 Nero - Black 	<ul style="list-style-type: none">  Y 2700K  6 3000K  W 3000K CRI > 90  9 4000K  1 5000K
 30° Lens	760116._ _	760117._ _		
 60° Lens	750116._ _	750117._ _		
 Vetro trasparente Transparent glass	720116._ _	720117._ _		
 Vetro satinato Frosted glass	710116._ _	710117._ _		
 40° Lens	740116._ _	740117._ _	<ul style="list-style-type: none">  1 Cromo lucido Shiny chrome  3 Grigio - Gray  4 Nero - Black 	<ul style="list-style-type: none">  Y 2700K  6 3000K  W 3000K CRI > 90  9 4000K  1 5000K
 130° Emission	700116._ _	700117._ _	<ul style="list-style-type: none">  1 Cromo lucido Shiny chrome  3 Grigio - Gray  4 Nero - Black 	<ul style="list-style-type: none">  Y 2700K  6 3000K  W 3000K CRI > 90  9 4000K  1 5000K

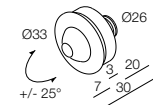
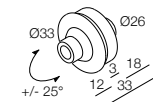
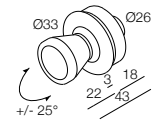

LED COLOUR
FINISH

ALIMENTATORI CONSIGLIATI (non inclusi)
SUGGESTED DRIVERS (not included)

350mA **CC20-F-350-N**
500mA **CC20-F-500-N**

pag. 190
pag. 192



Giovanni Battista De Poma, 1814-1880
Il cardinale Giovanni Battista De Poma
Ritratto di Giovanni Battista De Poma
Olio su tela
1814-1880
Giovanni Battista De Poma
Cardinale
1814-1880
Giovanni Battista De Poma
Cardinale
1814-1880

Ma partic

DGA

INTERNO
INDOOR



DGA

LA LUCE
PRENDE FORMA
THE LIGHT
TAKES SHAPE



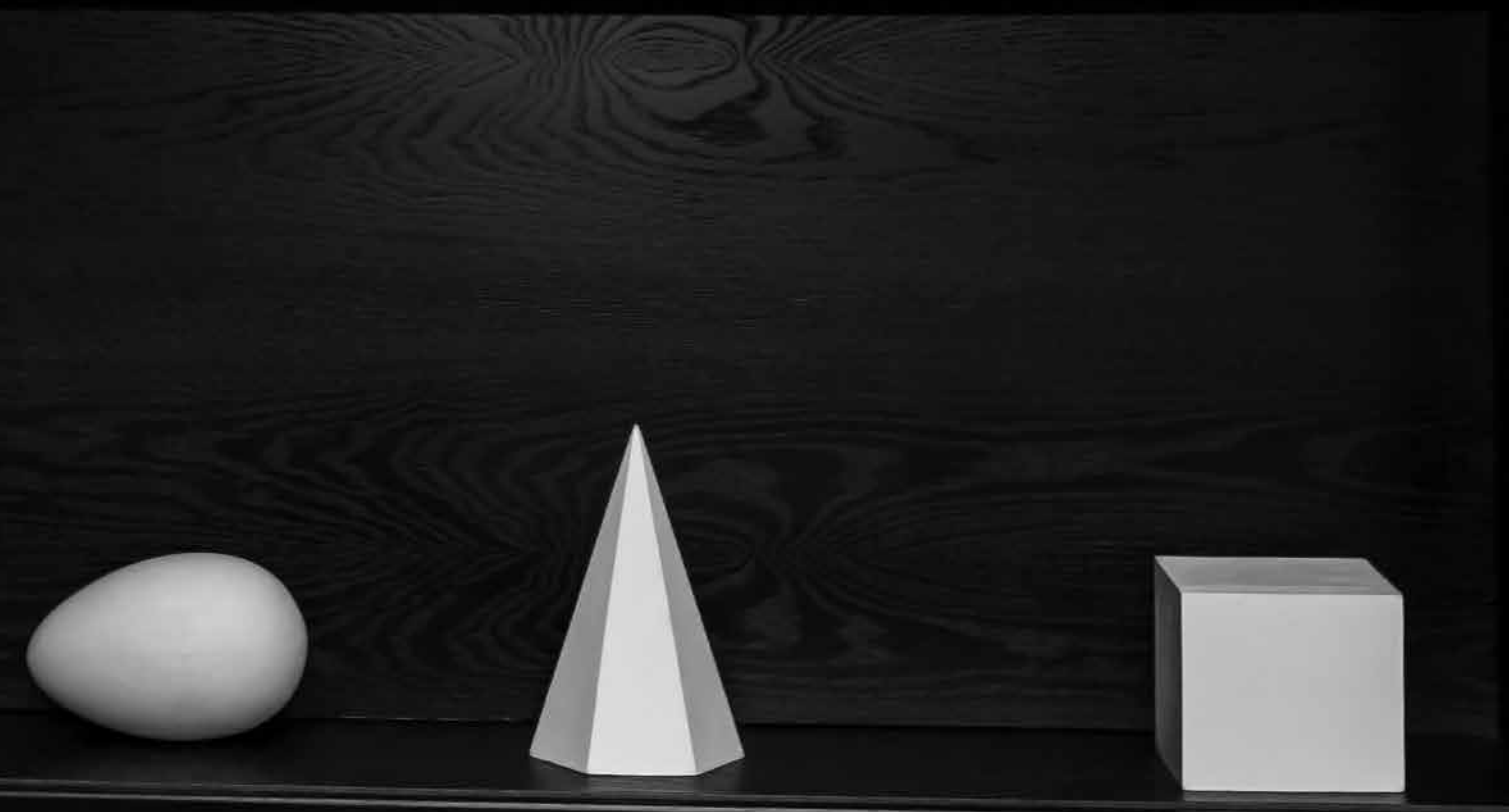
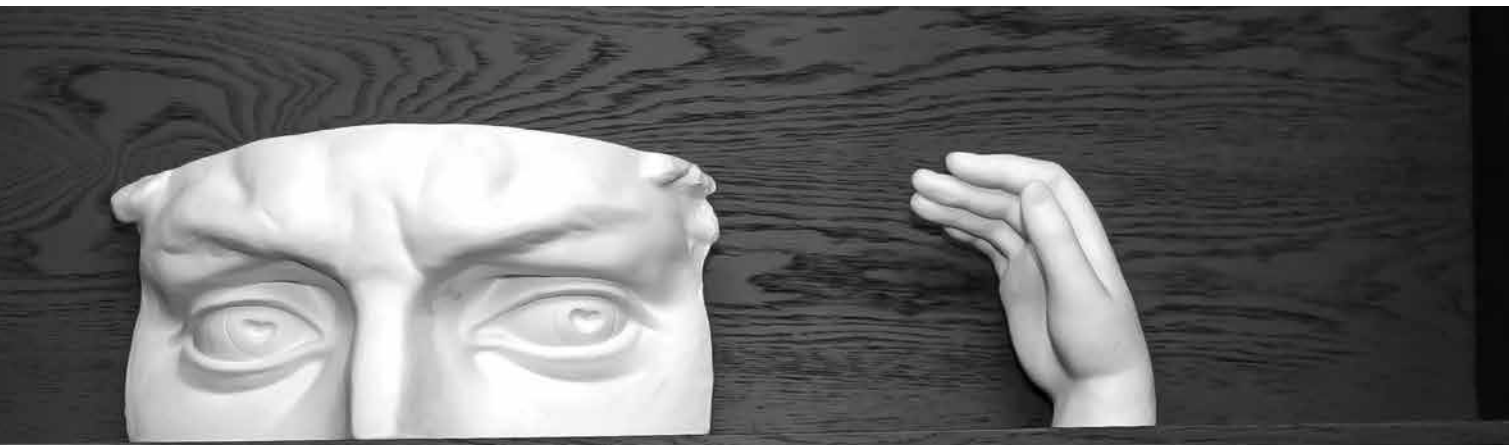



INCASSI CON CASSAFORMA

FIXTURES WITH HOUSING

100 ... 350 lm

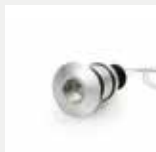

GEMMA 20 i
page 42



GEMMA 30 i
page 43



GEMMA 30 iR
page 46



GEMMA Qd 35 i
page 47



GEMMA 50 i
page 50









LUI
page 51



LEI
page 53







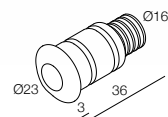









-  IP52 con cassaforma with housing
-  Class III
-  Incasso a parete, soffitto, pavimento Wall, ceiling, floor recessed
-  Carrabile 2000 kg Drive over up to 2000 kg
-  Lente 40° solo calpestabile 40° lens steppable only
-  Cavo 60 cm con connettore rapido 60 cm cable with quick connector
-  Collegare in serie 350mA o 500mA Connect in series at 350mA or 500mA
-  30 gr



GEMMA 20 i

	1W 350mA	2W 500mA	Finiture Finish	Colore LED LED Colour
Lumen 3000K	100lm	150lm		
 40° Lens	743063._ _	743064._ _	<ul style="list-style-type: none">  1 Cromo lucido Shiny chrome  3 Grigio - Gray  4 Nero - Black  6 AISI 316L Acciaio inox Stainless Steel 	<ul style="list-style-type: none">  Y 2700K  6 3000K  W 3000K CRI > 90  9 4000K  1 5000K
 Vetro trasparente Transparent glass	723063._ _	723064._ _		
 Vetro satinato Frosted glass	713063._ _	713064._ _		
	LED COLOUR			
	FINISH			

ALIMENTATORI CONSIGLIATI (non inclusi)
SUGGESTED DRIVERS (not included)

ACCESSORI
ACCESSORIES

350mA **CC20-F-350-N**
500mA **CC20-F-500-N**



pag. 190
pag. 192



Cassaforma
Housing
A00283.30







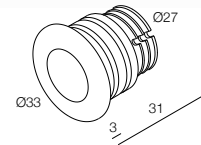

 Ø 19 mm



-  **IP52** con cassaforma
with housing
-  **Class III**
-  **Incasto a parete, soffitto, pavimento**
Wall, ceiling, floor recessed
-  **Carrabile 2000 kg**
Drive over up to 2000 kg
-  **Lente 60° solo calpestabile**
60° lens steppable only
-  **Possibilità di scelta tra 5 differenti ottiche**
Available in 5 different optics
-  **Cavo 60 cm con connettore rapido**
60 cm cable with quick connector
-  **Collegare in serie 350mA o 500mA**
Connect in series at 350mA or 500mA
-  **30 gr**



GEMMA 30 i

	1W 350mA	2W 500mA	3W 350mA	3W RGB 350mA	Finiture Finish	Colore LED LED Colour
Lumen 3000K	100lm	150lm	300lm	350lm		
 10° Lens	730160._ _	730161._ _			<ul style="list-style-type: none">  1 Cromo lucido Shiny chrome  3 Grigio - Gray  4 Nero - Black  6 AISI 316L Acciaio inox Stainless Steel 	
 30° Lens	760160._ _	760161._ _		760609._ 7		
 60° Lens	750160._ _	750161._ _	750162._ _			
 Vetro trasparente Transparent glass	720160._ _	720161._ _	720162._ _			
 Vetro satinato Frosted glass	710160._ _	710161._ _	710162._ _	710609._ 7		
	LED COLOUR					
	FINISH					

ALIMENTATORI CONSIGLIATI (non inclusi)
SUGGESTED DRIVERS (not included)

ACCESSORI
ACCESSORIES

350mA **CC20-F-350-N** pag. 190
500mA **CC20-F-500-N** pag. 192
350mA RGB **CC36-X-350-N** pag. 200



Cassaforma
Housing
A00102.30

 Ø 30 mm

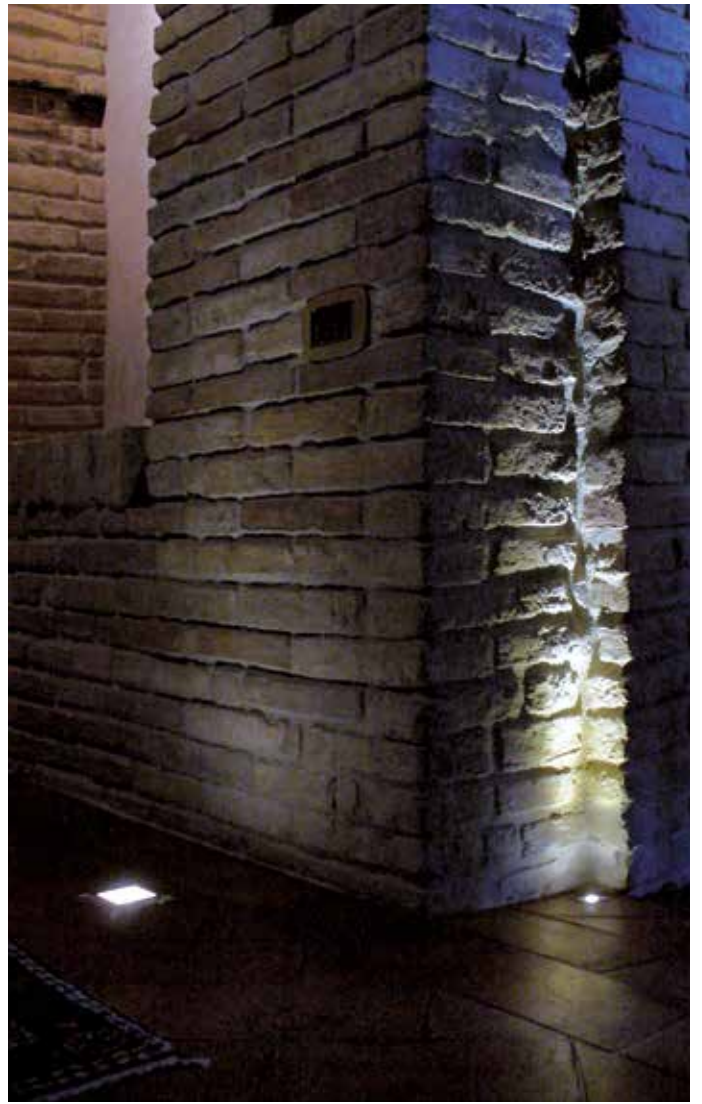































INCASSI CON CASSAFORMA
FIXTURES WITH HOUSING



-  IP52 con cassaforma with housing
-  Class III
-  Incasso a parete, soffitto, pavimento Wall, ceiling, floor recessed
-  Possibilità di scelta tra 7 differenti ottiche Available in 7 different optics
-  Cavo 60 cm con connettore rapido 60 cm cable with quick connector
-  Collegare in serie 350mA o 500mA Connect in series at 350mA or 500mA
-  35 gr



GEMMA 30 iR

	1W 350mA	2W 500mA	Finiture Finish	Colore LED LED Colour
Lumen 3000K	100lm	150lm		
 10° Lens	730163._ _	730164._ _	<ul style="list-style-type: none">  1 Cromo lucido Shiny chrome  3 Grigio - Gray  4 Nero - Black 	<ul style="list-style-type: none">  Y 2700K  6 3000K  W 3000K CRI > 90  9 4000K  1 5000K
 30° Lens	760163._ _	760164._ _		
 60° Lens	750163._ _	750164._ _		
 Vetro trasparente Transparent glass	720163._ _	720164._ _		
 Vetro satinato Frosted glass	710163._ _	710164._ _		
 40° Lens	740163._ _	740164._ _	<ul style="list-style-type: none">  1 Cromo lucido Shiny chrome  3 Grigio - Gray  4 Nero - Black 	<ul style="list-style-type: none">  Y 2700K  6 3000K  W 3000K CRI > 90  9 4000K  1 5000K
 130° Emission	700163._ _	700164._ _	<ul style="list-style-type: none">  1 Cromo lucido Shiny chrome  3 Grigio - Gray  4 Nero - Black 	<ul style="list-style-type: none">  Y 2700K  6 3000K  W 3000K CRI > 90  9 4000K  1 5000K

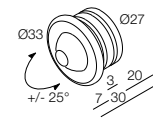
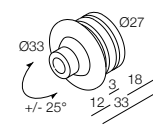
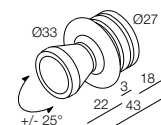

LED COLOUR
FINISH

ALIMENTATORI CONSIGLIATI (non inclusi)
SUGGESTED DRIVERS (not included)

ACCESSORI
ACCESSORIES

350mA CC20-F-350-N
500mA CC20-F-500-N

pag. 190
pag. 192









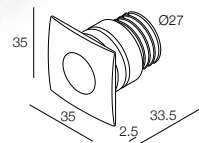







Cassaforma
Housing
A00102.30

 Ø 30 mm

-  IP52 con cassaforma with housing
-  Class III
-  Incasso a parete, soffitto, pavimento Wall, ceiling, floor recessed
-  Carrabile 2000 kg Drive over up to 2000 kg
-  Lente 60° solo calpestabile 60° lens steppable only
-  Possibilità di scelta tra 6 differenti ottiche Available in 6 different optics
-  Cavo 60 cm con connettore rapido 60 cm cable with quick connector
-  Collegare in serie 350mA o 500mA Connect in series at 350mA or 500mA
-  30 gr



GEMMA Qd 35 i

	1W 350mA	2W 500mA	3W 350mA	3W RGB 350mA	Finiture Finish	Colore LED LED Colour
Lumen 3000K	100lm	150lm	300lm	350lm		
 10° Lens	730448._ _	730449._ _			<ul style="list-style-type: none">  1 Cromo lucido Shiny chrome  3 Grigio - Gray  4 Nero - Black 	<ul style="list-style-type: none">  Y 2700K  6 3000K  W 3000K CRI > 90  9 4000K  1 5000K
 30° Lens	760448._ _	760449._ _		760611._ 7		
 60° Lens	750448._ _	750449._ _	750450._ _			
 Vetro trasparente Transparent glass	720448._ _	720449._ _	720450._ _			
 Vetro satinato Frosted glass	710448._ _	710449._ _	710450._ _	710611._ 7		
 Lente ellittica Elliptical lens	770448._ _	770449._ _				

LED COLOUR

FINISH

ALIMENTATORI CONSIGLIATI (non inclusi)
SUGGESTED DRIVERS (not included)









350mA CC20-F-350-N pag. 190
500mA CC20-F-500-N pag. 192
350mA RGB CC36-X-350-N pag. 200

ACCESSORI
ACCESSORIES









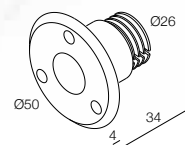







Cassaforma
Housing
A00102.30

 Ø 30 mm

-  **IP52** con cassaforma
with housing
-  **Class III**
-  **Incasso a parete, soffitto, pavimento**
Wall, ceiling, floor recessed
-  **Carrabile 2000 kg**
Drive over up to 2000 kg
-  **Lente 60° solo calpestabile**
60° lens steppable only
-  **Possibilità di scelta tra 6 differenti ottiche**
Available in 6 different optics
-  **Cavo 60 cm con connettore rapido**
60 cm cable with quick connector
-  **Collegare in serie 350mA o 500mA**
Connect in series at 350mA or 500mA
-  **80 gr**



GEMMA 50 i

	1W 350mA	2W 500mA	3W 350mA	3W RGB 350mA	Finiture Finish	Colore LED LED Colour
Lumen 3000K	100lm	150lm	300lm	350lm		
 10° Lens	730165._ _	730166._ _			<ul style="list-style-type: none">  1 Cromo lucido Shiny chrome  3 Grigio - Gray  6 AISI 316L Acciaio inox Stainless Steel  Y 2700K  6 3000K  W 3000K CRI > 90  9 4000K  1 5000K 	
 30° Lens	760165._ _	760166._ _		760616._ 7		
 60° Lens	750165._ _	750166._ _	750167._ _			
 Vetro trasparente Transparent glass	720165._ _	720166._ _	720167._ _			
 Vetro satinato Frosted glass	710165._ _	710166._ _	710167._ _	710616._ 7		
 Lente ellittica Elliptical lens	770165._ _	770166._ _				

LED COLOUR
FINISH

ALIMENTATORI CONSIGLIATI (non inclusi)
SUGGESTED DRIVERS (not included)

ACCESSORI
ACCESSORIES

350mA **CC20-F-350-N** pag. 190
500mA **CC20-F-500-N** pag. 192
350mA RGB **CC36-X-350-N** pag. 200



Cassaforma
Housing
A00103.30

 Ø 42 mm











LUI 01



LUI 02





























LUI 03

-  IP52 con cassaforma with housing
-  Class III
-  Incasso a parete Wall recessed
-  Cavo 60 cm con connettore rapido 60 cm cable with quick connector
-  Collegare in serie 350mA o 500mA Connect in series at 350mA or 500mA
-  40 gr



LUI

	1W 350mA	2W 500mA	Finiture Finish	Colore LED LED Colour
Lumen 3000K	100lm	150lm		
 45° Emission	720906._._	720907._._	<ul style="list-style-type: none">  3 Grigio - Gray  4 Nero - Black  7 Bianco - White  6 AISI 316L Acciaio inox Stainless Steel 	<ul style="list-style-type: none">  Y 2700K  6 3000K  9 4000K  1 5000K
 45° Emission	720904._._	720905._._	<ul style="list-style-type: none">  3 Grigio - Gray  4 Nero - Black  7 Bianco - White  6 AISI 316L Acciaio inox Stainless Steel 	<ul style="list-style-type: none">  Y 2700K  6 3000K  9 4000K  1 5000K
 45° Emission	720902._._	720903._._	<ul style="list-style-type: none">  3 Grigio - Gray  4 Nero - Black  7 Bianco - White  6 AISI 316L Acciaio inox Stainless Steel 	<ul style="list-style-type: none">  Y 2700K  6 3000K  9 4000K  1 5000K

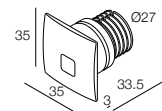

LUI 01

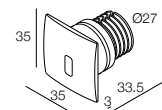

LUI 02

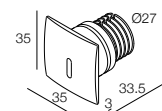

LUI 03

LED COLOUR
FINISH

ALIMENTATORI CONSIGLIATI (non inclusi)
SUGGESTED DRIVERS (not included)

350mA CC20-F-350-N
500mA CC20-F-500-N

pag. 190
pag. 192

ACCESSORI
ACCESSORIES



Cassaforma
Housing
A00102.30



Supporto con molle
Springs support
A00293.40

 Ø 30 mm

 Ø 33 mm









LEI 01



LEI 02





























LEI 03

-  **IP52** con cassaforma
with housing
-  **Class III**
-  **Incasso a parete**
Wall recessed
-  **Cavo 60 cm con connettore rapido**
60 cm cable with quick connector
-  **Collegare in serie 350mA o 500mA**
Connect in series at 350mA or 500mA
-  **40 gr**



LEI

	1W 350mA	2W 500mA	Finiture Finish	Colore LED LED Colour
Lumen 3000K	100lm	150lm		
 45° Emission	720815._._	720816._._	<ul style="list-style-type: none">  3 Grigio - Gray  4 Nero - Black  7 Bianco - White  6 AISI 316L Acciaio inox Stainless Steel 	<ul style="list-style-type: none">  Y 2700K  6 3000K  9 4000K  1 5000K
 45° Emission	720817._._	720818._._	<ul style="list-style-type: none">  3 Grigio - Gray  4 Nero - Black  7 Bianco - White  6 AISI 316L Acciaio inox Stainless Steel 	<ul style="list-style-type: none">  Y 2700K  6 3000K  9 4000K  1 5000K
 45° Emission	720813._._	720814._._	<ul style="list-style-type: none">  3 Grigio - Gray  4 Nero - Black  7 Bianco - White  6 AISI 316L Acciaio inox Stainless Steel 	<ul style="list-style-type: none">  Y 2700K  6 3000K  9 4000K  1 5000K

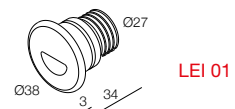

LEI 01

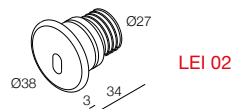

LEI 02

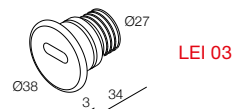

LEI 03

LED COLOUR
FINISH

ALIMENTATORI CONSIGLIATI (non inclusi)
SUGGESTED DRIVERS (not included)

350mA **CC20-F-350-N**
500mA **CC20-F-500-N**

pag. 190
pag. 192

ACCESSORI
ACCESSORIES



Cassaforma
Housing
A00102.30



Supporto con molle
Springs support
A00293.40

 Ø 30 mm

 Ø 33 mm



APPARECCHI A BINARIO E APPLIQUE

TRACK FIXTURES AND APPLIQUES

2300 ... 4000 lm



EMPORIO B+
page 57



EMPORIO PL+
page 64



**WALL
WASHER** **EMPORIO B**
WALL WASHER
page 61



EMPORIO PL
WALL WASHER
page 65

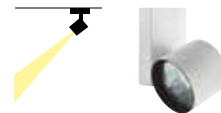

LINEA 8° **EOS B 8°**
8° BEAM page 62
ANGLE



EMPORIO B+

Sistema di dissipazione
brevettato DGA

Patented heat
dissipation system

Filtri intercambiabili
e sovrapponibili

Interchangeable
and overlapping filters



Ottica ad alto rendimento

High performing optic

ESALTARE NATURALMENTE OGNI DETTAGLIO

Un nuovo elemento della linea Emporio caratterizzato da un'ottica di 7 gradi. L'effetto è quello di una luce molto precisa e netta. Disponibile sia nella versione ad incasso, sia a binario.

HIGHLIGHT EACH SINGLE DETAIL

Emporio range has been enlarged with a new fitting with a super narrow 7° lens. The result is a precise and defined light cutout. It is available in both track mounted and recessed versions.

IP40

Class II

Binario a parete, soffitto
Wall, ceiling mounting track

Fornito con attacco a binario Eurostandard
Provided with Eurostandard track connector

2000 gr

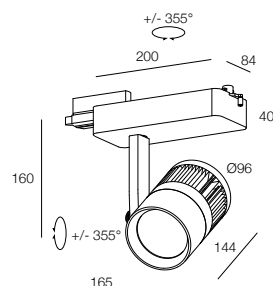

EMPORIO B+

	25W 110-240 Vac	35W 110-240 Vac	45W 110-240 Vac	Finiture Finish	Colore LED LED Colour
Lumen Output	2500lm	3100lm	4000lm		
7° Lens	7R3829._._	7R3830._._		3 Grigio - Gray 4 Nero - Black 7 Bianco - White	Y 2700K 6 3000K W 3000K CRI > 90 9 4000K
20° Reflector	783829._._	783830._._	783831._._		Z 3250K BRILLIANT SPECIAL RETAIL
30° Reflector	763829._._	763830._._	763831._._		
50° Reflector	7D3829._._	7D3830._._	7D3831._._		

EMPORIO B+ DIMM on BOARD

	25W 110-240 Vac	35W 110-240 Vac	45W 110-240 Vac	Finiture Finish	Colore LED LED Colour
Lumen Output	2500lm	3100lm	4000lm		
7° Lens	7R3823._._	7R3824._._		3 Grigio - Gray 4 Nero - Black 7 Bianco - White	Y 2700K 6 3000K W 3000K CRI > 90 9 4000K
20° Reflector	783823._._	783824._._	783825._._		Z 3250K BRILLIANT SPECIAL RETAIL
30° Reflector	763823._._	763824._._	763825._._		
50° Reflector	7D3823._._	7D3824._._	7D3825._._		

EMPORIO B+ DALI

	25W 110-240 Vac	35W 110-240 Vac	45W 110-240 Vac	Finiture Finish	Colore LED LED Colour
Lumen Output	2500lm	3100lm	4000lm		
7° Lens	7R3817._._	7R3818._._		3 Grigio - Gray 4 Nero - Black 7 Bianco - White	Y 2700K 6 3000K W 3000K CRI > 90 9 4000K
20° Reflector	783817._._	783818._._	783819._._		Z 3250K BRILLIANT SPECIAL RETAIL
30° Reflector	763817._._	763818._._	763819._._		
50° Reflector	7D3817._._	7D3818._._	7D3819._._		

LED COLOUR

FINISH

ACCESSORI
ACCESSORIES



Accessori binario
Accessories for tracks
page 212



Nido D'ape
Hex Louver
A00496.40



Filtro Correttivo
Softening Lens
A00497.80

NOTA: Gli apparecchi Emporio B+ ed Emporio PL+ sono in fase di restyling (le caratteristiche illuminotecniche non subiranno modifiche).
Contattare l'ufficio commerciale per maggiori informazioni.

NOTE: We are currently re-designing Emporio B+ and Emporio PL+ fixtures (the technical features will not change).
For further information, please contact the sales department.

DGA

INTERNO
INDOOR



EMPORIO B+



Ambiance
Muur

Ambiance
Muur





Sistema di dissipazione
brevettato DGA

Patented heat
dissipation system

Luce omogenea

Homogenous light





Ideale per esposizione

Perfect for exhibition

EMPORIO B WallWasher







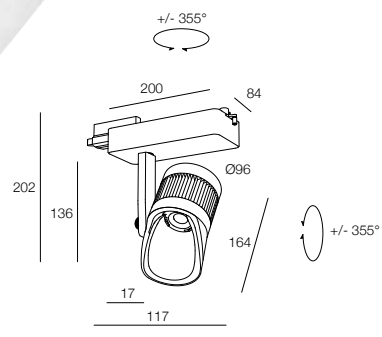

WALL WASHER



-  IP40
-  Class II
-  Binario a parete, soffitto
Wall, ceiling mounting track
-  Fornito con attacco a binario Eurostandard
Provided with Eurostandard track connector
-  2000 gr



EMPORIO B WallWasher

	25W 110-240 Vac	35W 110-240 Vac	45W 110-240 Vac	Finiture Finish	Colore LED LED Colour
Lumen Output	2300lm	2800lm	3200lm		
Wall Washer	7W3700._ _	7W3701._ _	7W3702._ _	<ul style="list-style-type: none">  3 Grigio - Gray  4 Nero - Black  7 Bianco - White 	<ul style="list-style-type: none">  Y 2700K  6 3000K  W 3000K CRI > 90  9 4000K
					 Z 3250K BRILLIANT SPECIAL RETAIL





LED COLOUR
FINISH

ACCESSORI ACCESSORIES



Accessori binario
Accessories for tracks
page 212



-  IP40
-  Class II
-  Binario a parete, soffitto
Wall, ceiling mounting track
-  Fornito con attacco a binario Eurostandard
Provided with Eurostandard track connector
-  900 gr

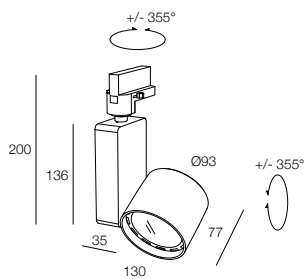

EOS B 8°

16W
110-240Vac

Finiture
Finish

Colore LED
LED Colour

 8° Lens





783699._ _

-  3 Grigio - Gray
-  4 Nero - Black
-  7 Bianco - White

-  Y 2700K
-  6 3000K
-  9 4000K
-  1 5000K







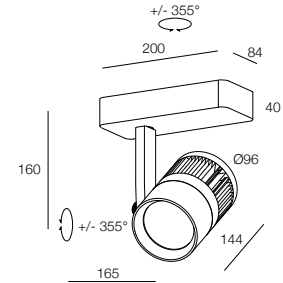





LED COLOUR
FINISH















-  IP40
-  Class II
-  Montaggio a parete, soffitto
Wall, ceiling mounting
-  Alimentazione integrata
Built-in driver
-  1750 gr















EMPORIO PL+

	25W 110-240 Vac	35W 110-240 Vac	45W 110-240 Vac	Finiture Finish	Colore LED LED Colour
Lumen Output	2500lm	3100lm	4000lm		
 7° Lens	7R3832._ _	7R3833._ _		 3 Grigio - Gray	 Y 2700K
 20° Reflector	783832._ _	783833._ _	783834._ _	 4 Nero - Black	 6 3000K
 30° Reflector	763832._ _	763833._ _	763834._ _	 7 Bianco - White	 W 3000K CRI > 90
 50° Reflector	7D3832._ _	7D3833._ _	7D3834._ _		 9 4000K
					 Z 3250K BRILLIANT SPECIAL RETAIL

EMPORIO PL+ DIMM on BOARD

	25W 110-240 Vac	35W 110-240 Vac	45W 110-240 Vac	Finiture Finish	Colore LED LED Colour
Lumen Output	2500lm	3100lm	4000lm		
 7° Lens	7R3826._ _	7R3827._ _		 3 Grigio - Gray	 Y 2700K
 20° Reflector	783826._ _	783827._ _	783828._ _	 4 Nero - Black	 6 3000K
 30° Reflector	763826._ _	763827._ _	763828._ _	 7 Bianco - White	 W 3000K CRI > 90
 50° Reflector	7D3826._ _	7D3827._ _	7D3828._ _		 9 4000K
					 Z 3250K BRILLIANT SPECIAL RETAIL

EMPORIO PL+ DALI

	25W 110-240 Vac	35W 110-240 Vac	45W 110-240 Vac	Finiture Finish	Colore LED LED Colour
Lumen Output	2500lm	3100lm	4000lm		
 7° Lens	7R3820._ _	7R3821._ _		 3 Grigio - Gray	 Y 2700K
 20° Reflector	783820._ _	783821._ _	783822._ _	 4 Nero - Black	 6 3000K
 30° Reflector	763820._ _	763821._ _	763822._ _	 7 Bianco - White	 W 3000K CRI > 90
 50° Reflector	7D3820._ _	7D3821._ _	7D3822._ _		 9 4000K
					 Z 3250K BRILLIANT SPECIAL RETAIL

LED COLOUR
FINISH

ACCESSORI
ACCESSORIES

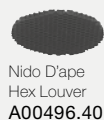





NOTA: Gli apparecchi Emporio B+ ed Emporio PL+ sono in fase di restyling (le caratteristiche illuminotecniche non subiranno modifiche). Contattare l'ufficio commerciale per maggiori informazioni.

NOTE: We are currently re-designing Emporio B+ and Emporio PL+ fixtures (the technical features will not change). For further information, please contact the sales department.







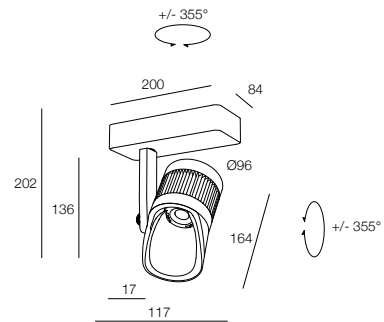

WALL WASHER



-  IP40
-  Class II
-  Montaggio a parete, soffitto
Wall, ceiling mounting
-  Alimentazione integrata
Built-in driver
-  1750 gr









EMPORIO PL WallWasher





	25W 110-240 Vac	35W 110-240 Vac	45W 110-240 Vac	Finiture Finish	Colore LED LED Colour
Lumen Output	2300lm	2800lm	3200lm		
				<ul style="list-style-type: none">  3 Grigio - Gray  4 Nero - Black  7 Bianco - White 	<ul style="list-style-type: none">  Y 2700K  6 3000K  W 3000K CRI > 90  9 4000K
 Wall Washer	7W3703._ _	7W3704._ _	7W3705._ _		<ul style="list-style-type: none">  Z 3250K BRILLIANT SPECIAL RETAIL

LED COLOUR
FINISH



-  IP40
-  Class III
-  Montaggio a parete, soffitto, pavimento
Wall, ceiling, floor mounting
-  Disponibile in 3 lunghezze e 5 ottiche
Available in 3 different lengths and 5 optics
-  Collegare in serie 350mA o 500mA
Connect in series at 350mA or 500mA
-  270 gr
-  Ø 13 mm

READING LIGHT FLEX 25



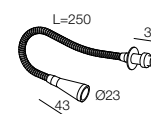

	1W 350mA	2W 500mA	Finiture Finish	Colore LED LED Colour
Lumen 3000K	100lm	150lm		
 10° Lens	730269._ _	730270._ _	<input type="checkbox"/> 1 Cromo lucido Shiny chrome	<input type="checkbox"/> Y 2700K <input type="checkbox"/> 6 3000K <input type="checkbox"/> W 3000K CRI > 90 <input type="checkbox"/> 9 4000K <input type="checkbox"/> 1 5000K
 30° Lens	760269._ _	760270._ _	<input type="checkbox"/> 2 Cromo opaco Matt Chrome	
 40° Lens	740269._ _	740270._ _		
 Vetro trasparente Transparent glass	720269._ _	720270._ _		
 Vetro satinato Frosted glass	710269._ _	710270._ _		

LED COLOUR
FINISH

READING LIGHT
FLEX 25



READING LIGHT FLEX 50

	1W 350mA	2W 500mA	Finiture Finish	Colore LED LED Colour
Lumen 3000K	100lm	150lm		
 10° Lens	730263._ _	730264._ _	<input type="checkbox"/> 1 Cromo lucido Shiny chrome	<input type="checkbox"/> Y 2700K <input type="checkbox"/> 6 3000K <input type="checkbox"/> W 3000K CRI > 90 <input type="checkbox"/> 9 4000K <input type="checkbox"/> 1 5000K
 30° Lens	760263._ _	760264._ _	<input type="checkbox"/> 2 Cromo opaco Matt Chrome	
 40° Lens	740263._ _	740264._ _		
 Vetro trasparente Transparent glass	720263._ _	720264._ _		
 Vetro satinato Frosted glass	710263._ _	710264._ _		

LED COLOUR
FINISH

READING LIGHT
FLEX 50

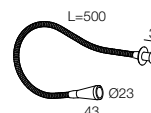

ALIMENTATORI CONSIGLIATI (non inclusi)
SUGGESTED DRIVERS (not included)

350mA **CC20-F-350-N**
500mA **CC20-F-500-N**

pag. 190
pag. 192



IP40

Class II

Montaggio a parete, soffitto, pavimento
Wall, ceiling, floor mounting

Disponibile in 2 lunghezze e 5 ottiche
Available in 2 different lengths and 5 optics

Alimentazione integrata, collegare alla tensione di rete 100/240Vac
Built-in driver, connect to the main voltage 100/240Vac

400 gr

READING LIGHT FLEX P 25

	1W 100-240 Vac	2W 100-240 Vac	Finiture Finish	Colore LED LED Colour
Lumen 3000K	100lm	150lm		
10° Lens	730558._ _	730560._ _	1 Cromo lucido Shiny chrome	Y 2700K 6 3000K W 3000K CRI > 90 9 4000K 1 5000K
30° Lens	760558._ _	760560._ _	2 Cromo opaco Matt Chrome	
40° Lens	740558._ _	740560._ _		
Vetro trasparente Transparent glass	720558._ _	720560._ _		
Vetro satinato Frosted glass	710558._ _	710560._ _		

READING LIGHT
FLEX P 25

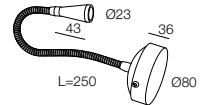

READING LIGHT FLEX P 50

	1W 100-240 Vac	2W 100-240 Vac	Finiture Finish	Colore LED LED Colour
Lumen 3000K	100lm	150lm		
10° Lens	730559._ _	730561._ _	1 Cromo lucido Shiny chrome	Y 2700K 6 3000K W 3000K CRI > 90 9 4000K 1 5000K
30° Lens	760559._ _	760561._ _	2 Cromo opaco Matt Chrome	
40° Lens	740559._ _	740561._ _		
Vetro trasparente Transparent glass	720559._ _	720561._ _		
Vetro satinato Frosted glass	710559._ _	710561._ _		

READING LIGHT
FLEX P 50

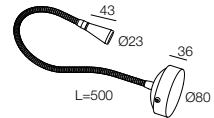



DGN

OUT DOOR 2017





INCASSI A MOLLE

FIXTURES WITH SPRINGS



100 ... 300 lm



GEMMA 20 IP67 m
page 72



GEMMA 35 IP67 m
page 73









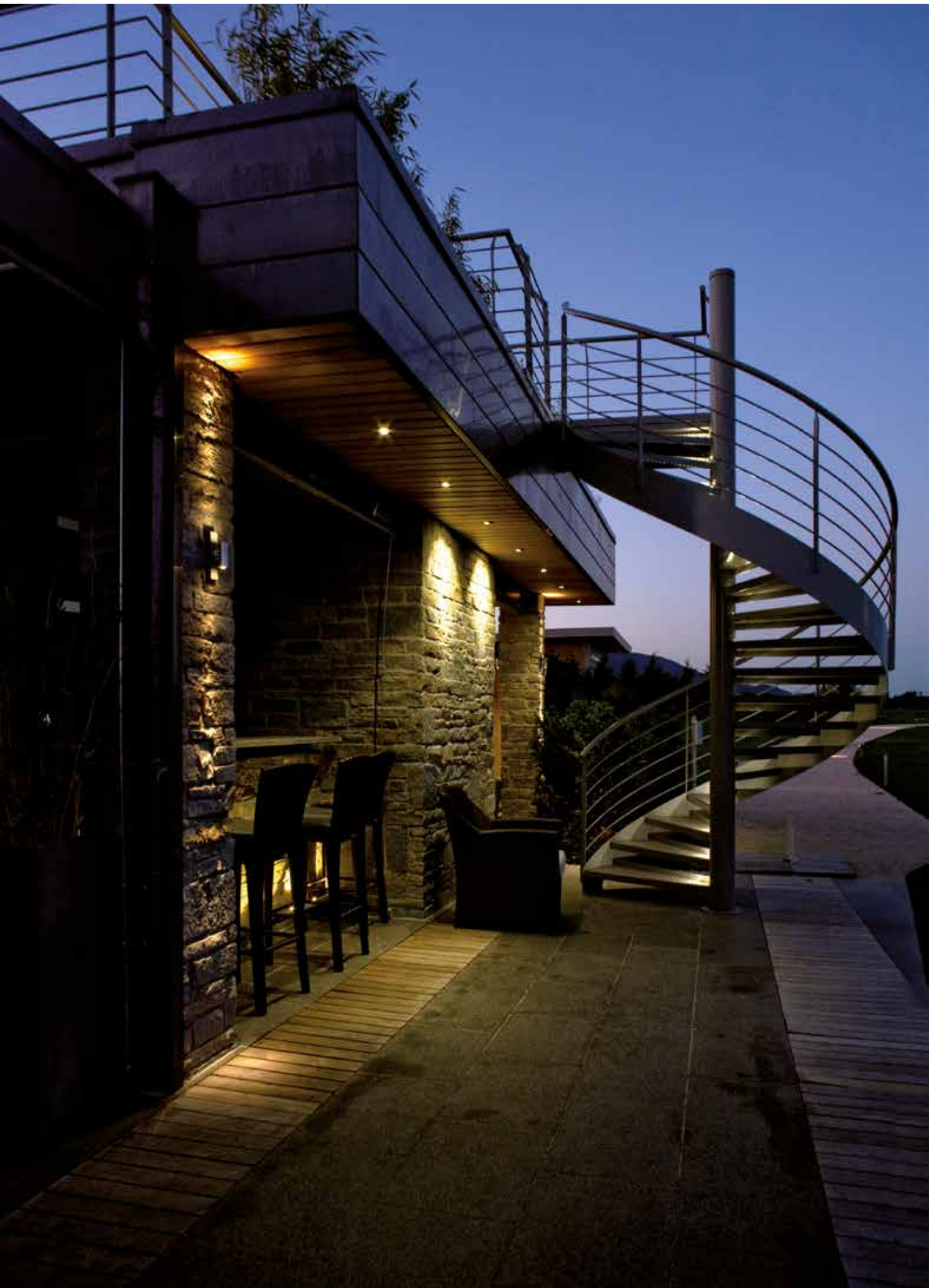

GEMMA Qd 35 IP67 m
page 75









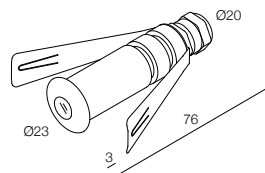

ARCO 60 m
page 79



-  IP67
-  Class III
-  Incasso a parete, pavimento
Wall, floor recessed
-  Carrabile 2000 kg
Drive over up to 2000 kg
-  Cavo in neoprene 100 cm
100 cm neoprene cable
-  Collegare in serie 350mA o 500mA
Connect in series at 350mA or 500mA
-  72 gr
-  Ø 20 mm



GEMMA 20 IP67 m

	1W 350mA	2W 500mA	Finiture Finish	Colore LED LED Colour
Lumen 3000K	100lm	150lm		
 Vetro trasparente Transparent glass	723040._ _ L	723041._ _ L	 3 Grigio - Gray  4 Nero - Black  6 AISI 316L Acciaio inox Stainless Steel	 Y 2700K  6 3000K  9 4000K  1 5000K
 Vetro satinato Frosted glass	713040._ _ L	713041._ _ L		

LED COLOUR
FINISH

ALIMENTATORI CONSIGLIATI (non inclusi)
SUGGESTED DRIVERS (not included)

ACCESSORI
ACCESSORIES

350mA **CC20-F-350-N**
500mA **CC20-F-500-N**

pag. 190
pag. 192







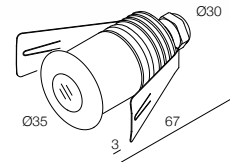







Micro connettore
stagno
Micro watertight
connector
A00357.40

-  IP67
-  Class III
-  Incasso a parete, soffitto, pavimento
Wall, ceiling, floor recessed
-  Carrabile 2000 kg
Drive over up to 2000 kg
-  Possibilità di scelta tra 6 differenti ottiche
Available in 6 different optics
-  Cavo in neoprene 100 cm
100 cm neoprene cable
-  Collegare in serie 350mA o 500mA
Connect in series at 350mA or 500mA
-  100 gr
-  Ø 31 mm



GEMMA 35 IP67 m

	1W 350mA	2W 500mA	3W 350mA	Finiture Finish	Colore LED LED Colour
Lumen 3000K	100lm	150lm	300lm		
 10° Lens	730917._ _ L	730918._ _ L		 3 Grigio - Gray  4 Nero - Black  6 AISI 316L Acciaio inox Stainless Steel	 Y 2700K  6 3000K  9 4000K  1 5000K
 30° Lens	760917._ _ L	760918._ _ L			
 40° Lens	740917._ _ L	740918._ _ L			
 Vetro trasparente Transparent glass	720917._ _ L	720918._ _ L	720919._ _ L		
 Vetro satinato Frosted glass	710917._ _ L	710918._ _ L	710919._ _ L		
 Lente ellittica Elliptical lens	770917._ _ L	770918._ _ L			

LED COLOUR
FINISH

ALIMENTATORI CONSIGLIATI (non inclusi)
SUGGESTED DRIVERS (not included)

350mA **CC20-F-350-N**
500mA **CC20-F-500-N**



pag. 190
pag. 192

ACCESSORI
ACCESSORIES









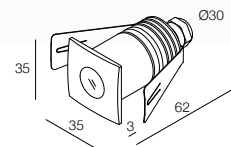





Micro connettore
stagno
Micro watertight
connector
A00357.40



-  IP67
-  Class III
-  Incasso a parete, soffitto, pavimento
Wall, ceiling, floor recessed
-  Carrabile 2000 kg
Drive over up to 2000 kg
-  Possibilità di scelta tra 6 differenti ottiche
Available in 6 different optics
-  Cavo in neoprene 100 cm
100 cm neoprene cable
-  Collegare in serie 350mA o 500mA
Connect in series at 350mA or 500mA
-  120 gr
-  Ø 31 mm



GEMMA Qd 35 IP67 m

	1W 350mA	2W 500mA	3W 350mA	Finiture Finish	Colore LED LED Colour
Lumen 3000K	100lm	150lm	300lm		
 10° Lens	730941. __ L	730942. __ L		<ul style="list-style-type: none">  3 Gris - Gray  4 Nero - Black  6 AISI 316L Acciaio inox Stainless Steel 	<ul style="list-style-type: none">  Y 2700K  6 3000K  9 4000K  1 5000K
 30° Lens	760941. __ L	760942. __ L			
 40° Lens	740941. __ L	740942. __ L			
 Vetro trasparente Transparent glass	720941. __ L	720942. __ L	720958. __ L		
 Vetro satinato Frosted glass	710941. __ L	710942. __ L	710958. __ L		
 Lente ellittica Elliptical lens	770941. __ L	770942. __ L			

LED COLOUR

FINISH

ALIMENTATORI CONSIGLIATI (non inclusi)
SUGGESTED DRIVERS (not included)

350mA **CC20-F-350-N**
500mA **CC20-F-500-N**

pag. 190
pag. 192

ACCESSORI
ACCESSORIES



Micro connettore
stagno
Micro watertight
connector
A00357.40



INCASSI A MOLLE PER ESTERNO

OUTDOOR FIXTURES WITH SPRINGS







-  IP67
-  Class III
-  Incasso a parete, soffitto, pavimento
Wall, ceiling, floor recessed
-  Carrabile 2000 kg
Drive over up to 2000 kg
-  Cavo in neoprene 100 cm
100 cm neoprene cable
-  Collegare in serie 350mA
Connect in series at 350mA
-  Collegare in parallelo 24Vdc
Connect in parallel at 24Vdc
-  370 gr
-  Ø 45 mm

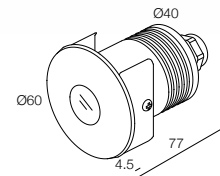

ARCO 60 IP67 m

	3W 350mA	3W 24 Vdc	3W RGB 350mA	Finiture Finish	Colore LED LED Colour
Lumen 3000K	300lm	300lm			
 15° Lens	7A0849._ _	7A0851._ _		<ul style="list-style-type: none">  3 Grigio - Gray  6 AISI 316L Acciaio inox Stainless Steel  Y 2700K  6 3000K  9 4000K  1 5000K 	
 30° Lens	760849._ _	760851._ _	760849._ 7		
 60° Lens	750849._ _	750851._ _			
 Vetro satinato Frosted glass	710850._ _	710852._ _	710850._ 7		
 Lente ellittica Elliptical lens	770849._ _	770851._ _			

LED COLOUR
FINISH

ALIMENTATORI CONSIGLIATI (non inclusi)
SUGGESTED DRIVERS (not included)

350mA CC20-F-350-N pag. 190
350mA RGB CC36-X-350-N pag. 200
24 Vdc CV20-F-24-N pag. 197

ACCESSORI
ACCESSORIES



Connettore stagno
Watertight connector
A00387.40



TRATTAMENTI SPECIFICI
DI FINITURA E PROTEZIONE
SPECIFIC TREATMENTS
OF FINISH AND PROTECTION



La qualità delle lavorazioni meccaniche DGA si riconosce anche al tatto. La superficie dei componenti metallici parla della cura con cui vengono lavorati. Una volta scavata dal blocco di alluminio con macchine a controllo numerico, la parte subisce un trattamento di pulimentatura, per essere poi lucidata o satinata. Viene infine immersa in bagni Galvanici che ne ossidano la superficie e le conferiscono durezza e resistenza agli agenti atmosferici.

The quality of DGA mechanical workings can be recognised even by touching them. The surface of the metallic components indicates the carefulness in the manufacture. Once it is dug from the solid aluminum bar with numerically controlled machines, the component is first subjected to a buffing treatment, to be polished or satinised. It is then dipped into galvanic baths which oxidise the surface and give it hardness and weather resistance.



INCASSI CON CASSAFORMA

FIXTURES WITH HOUSING



100 ... 450 lm



GEMMA 20 IP67
page 85



GEMMA 35 IP67
page 86



GEMMA Qd 35 IP67
page 87



ASTRO 80
page 88



ASTRO Qd 80
page 89



ARCO 60 i
page 91



NESIS H65
page 92

600 ... 1400 lm







AURA 6-8
page 94



AURA 12
page 97





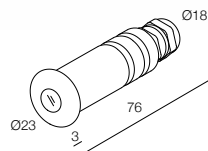

-  IP67
-  Class III
-  Incasso a parete, pavimento
Wall, floor recessed
-  Carrabile 2000 kg
Drive over up to 2000 kg
-  Installazione con controcassa consigliata
Recessed box recommended
-  Cavo in neoprene 100 cm
100 cm neoprene cable
-  Collegare in serie 350mA o 500mA
Connect in series at 350mA or 500mA
-  72 gr



GEMMA 20 IP67

	1W 350mA	2W 500mA	Finiture Finish	Colore LED LED Colour
Lumen 3000K	100lm	150lm		
 Vetro trasparente Transparent glass	723040._ _	723041._ _	<input type="checkbox"/> 3 Grigio - Gray <input type="checkbox"/> 4 Nero - Black <input type="checkbox"/> 6 AISI 316L Acciaio inox Stainless Steel	<input type="checkbox"/> Y 2700K <input type="checkbox"/> 6 3000K <input type="checkbox"/> 9 4000K <input type="checkbox"/> 1 5000K
 Vetro satinato Frosted glass	713040._ _	713041._ _		

LED COLOUR

FINISH

ALIMENTATORI CONSIGLIATI (non inclusi)
SUGGESTED DRIVERS (not included)

350mA **CC20-F-350-N**
500mA **CC20-F-500-N**

pag. 190
pag. 192

ACCESSORI
ACCESSORIES



Controcassa
Recessed box
A00285.30











Controcassa
Recessed box
A00326.40









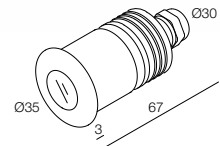





Micro connettore
stagno
Micro watertight
connector
A00357.40

 Ø 23 mm

-  IP67
-  Class III
-  Incasso a parete, soffitto, pavimento
Wall, ceiling, floor recessed
-  Carrabile 2000 kg
Drive over up to 2000 kg
-  Possibilità di scelta tra 6 differenti ottiche
Available in 6 different optics
-  Installazione con controcassa consigliata
Recessed box recommended
-  Cavo in neoprene 100 cm
100 cm neoprene cable
-  Collegare in serie 350mA o 500mA
Connect in series at 350mA or 500mA
-  100 gr



GEMMA 35 IP67

	1W 350mA	2W 500mA	3W 350mA	Finiture Finish	ColoreED LED Colour
Lumen 3000K	100lm	150lm	300lm		
 10° Lens	730917._ _	730918._ _		 3 Grigio - Gray	 Y 2700K
 30° Lens	760917._ _	760918._ _		 4 Nero - Black	 6 3000K
 40° Lens	740917._ _	740918._ _		 6 AISI 316L Acciaio inox Stainless Steel	 9 4000K
 Vetro trasparente Transparent glass	720917._ _	720918._ _	720919._ _		 1 5000K
 Vetro satinato Frosted glass	710917._ _	710918._ _	710919._ _		
 Lente ellittica Elliptical lens	770917._ _	770918._ _			

LED COLOUR
FINISH

ALIMENTATORI CONSIGLIATI (non inclusi)
SUGGESTED DRIVERS (not included)

350mA **CC20-F-350-N**
500mA **CC20-F-500-N**

pag. 190
pag. 192

ACCESSORI
ACCESSORIES



Controcassa
Recessed box
A00161.30











Controcassa
Recessed box
A00249.40









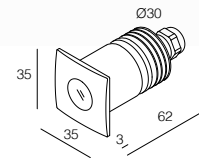





Micro connettore
stagno
Micro watertight
connector
A00357.40

 Ø 40 mm

-  IP67
-  Class III
-  Incasso a parete, soffitto, pavimento
Wall, ceiling, floor recessed
-  Carrabile 2000 kg
Drive over up to 2000 kg
-  Possibilità di scelta tra 6 differenti ottiche
Available in 6 different optics
-  Installazione con controcassa consigliata
Recessed box recommended
-  Cavo in neoprene 100 cm
100 cm neoprene cable
-  Collegare in serie 350mA o 500mA
Connect in series at 350mA or 500mA
-  120 gr



GEMMA Qd 35 IP67

	1W 350mA	2W 500mA	3W 350mA	Finiture Finish	ColoreED LED Colour
Lumen 3000K	100lm	150lm	300lm		
 10° Lens	730941. _ _	730942. _ _		 3 Grigio - Gray  4 Nero - Black  6 AISI 316L Acciaio inox Stainless Steel	 Y 2700K  6 3000K  9 4000K  1 5000K
 30° Lens	760941. _ _	760942. _ _			
 40° Lens	740941. _ _	740942. _ _			
 Vetro trasparente Transparent glass	720941. _ _	720942. _ _	720958. _ _		
 Vetro satinato Frosted glass	710941. _ _	710942. _ _	710958. _ _		
 Lente ellittica Elliptical lens	770941. _ _	770942. _ _			

LED COLOUR

FINISH

ALIMENTATORI CONSIGLIATI (non inclusi)
SUGGESTED DRIVERS (not included)

350mA **CC20-F-350-N**
500mA **CC20-F-500-N**

pag. 190
pag. 192

ACCESSORI
ACCESSORIES



Controcassa
Recessed box
A00161.30











Controcassa
Recessed box
A00249.40









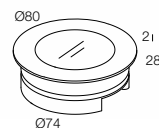





Micro connettore
stagno
Micro watertight
connector
A00357.40

 Ø 40 mm

-  IP67
-  Class III
-  Incasso a parete, pavimento
Wall, floor recessed
-  Carrabile 2000 kg
Drive over up to 2000 kg
-  Cavo in neoprene 100 cm
100 cm neoprene cable
-  Installazione con controcassa obbligatoria
Recessed box needed
-  Collegare in serie 350mA o 500mA
Connect in series at 350mA or 500mA
-  300 gr



ASTRO 80

	1W 350mA	2W 500mA	3W 350mA	Finiture Finish	Colore LED LED Colour
Lumen 3000K	100lm	150lm	300lm		
 15° Lens			7A0858._ _	<ul style="list-style-type: none">  3 Grigio - Gray  4 Nero - Black  6 AISI 316L Acciaio inox Stainless Steel 	<ul style="list-style-type: none">  Y 2700K  6 3000K  9 4000K  1 5000K
 30° Lens			760858._ _		
 60° Lens			750858._ _		
 Vetro satinato Frosted glass	710857._ _	710796._ _			
 Lente ellittica Elliptical lens			770858._ _		

LED COLOUR
FINISH

ALIMENTATORI CONSIGLIATI (non inclusi)
SUGGESTED DRIVERS (not included)

ACCESSORI
ACCESSORIES

350mA **CC20-F-350-N**
500mA **CC20-F-500-N**

pag. 190
pag. 192











Controcassa
Recessed box
A00247.30



Micro connettore
stagno
Micro watertight
connector
A00357.40







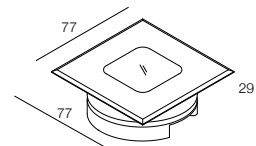





 Ø 74 mm



-  IP67
-  Class III
-  Incasso a parete, pavimento
Wall, floor recessed
-  Carrabile 2000 kg
Drive over up to 2000 kg
-  Cavo in neoprene 100 cm
100 cm neoprene cable
-  Installazione con controcassa obbligatoria
Recessed box needed
-  Collegare in serie 350mA o 500mA
Connect in series at 350mA or 500mA
-  300 gr



ASTRO Qd 80

	1W 350mA	2W 500mA	3W 350mA	Finiture Finish	Colore LED LED Colour
Lumen 3000K	100lm	150lm	300lm		
 15° Lens			7A3590._ _	 3 Grigio - Gray  4 Nero - Black  6 AISI 316L Acciaio inox Stainless Steel	 Y 2700K  6 3000K  9 4000K  1 5000K
 30° Lens			763590._ _		
 60° Lens			753590._ _		
 Vetro satinato Frosted glass	713591._ _	713592._ _			
 Lente ellittica Elliptical lens			773590._ _		

LED COLOUR
FINISH

ALIMENTATORI CONSIGLIATI (non inclusi)
SUGGESTED DRIVERS (not included)

ACCESSORI
ACCESSORIES

350mA **CC20-F-350-N** pag. 190
500mA **CC20-F-500-N** pag. 192



Controcassa
Recessed box
A00247.30

 Ø 74 mm



Micro connettore
stagno
Micro watertight
connector
A00357.40



90





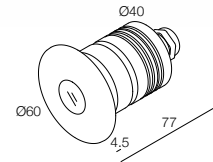

-  IP67
-  Class III
-  Incasso a parete, soffitto, pavimento
Wall, ceiling, floor recessed
-  Carrabile 2000 kg
Drive over up to 2000 kg
-  Cavo in neoprene 100 cm
100 cm neoprene cable
-  Installazione con controcassa consigliata
Recessed box recommended
-  Collegare in serie 350mA
Connect in series at 350mA
-  Collegare in parallelo 24Vdc
Connect in parallel at 24Vdc
-  250 gr



ARCO 60 i

	3W 350mA	3W 24 Vdc	3W RGB 350mA	Finiture Finish	Colore LED LED Colour
Lumen 3000K	300lm	300lm			
 15° Lens	7A0788._ _	7A0828._ _		<input type="checkbox"/> 3 Grigio - Gray <input type="checkbox"/> 6 AISI 316L Acciaio inox Stainless Steel	<input type="checkbox"/> Y 2700K <input type="checkbox"/> 6 3000K <input type="checkbox"/> 9 4000K <input type="checkbox"/> 1 5000K
 30° Lens	760788._ _	760828._ _	760788._ 7		
 60° Lens	750788._ _	750828._ _			
 Vetro satinato Frosted glass	710789._ _	710829._ _	710789._ 7		
 Lente ellittica Elliptical lens	770788._ _	770828._ _			

LED COLOUR
FINISH

ALIMENTATORI CONSIGLIATI (non inclusi)
SUGGESTED DRIVERS (not included)

350mA CC20-F-350-N pag. 190
350mA RGB CC36-X-350-N pag. 200
24 Vdc CV20-F-24-N pag. 197

ACCESSORI
ACCESSORIES









Controcassa
Recessed box
A00129.30

Controcassa
Recessed box
A00250.40





Connettore stagno
Watertight connector
A00387.40

 Ø 50 mm



-  IP67
-  Class III
-  Incasso a parete, soffitto, pavimento
Wall, ceiling, floor recessed
-  Carrabile 2000 kg
Drive over up to 2000 kg
-  Cavo in neoprene 100 cm
100 cm neoprene cable
-  Installazione con controcassa consigliata
Recessed box recommended
-  Collegare in serie 350mA o 500mA
Connect in series at 350mA or 500mA
-  400 gr

NESIS H65

	3W 350mA	6W 500mA	3W RGB 350mA	Finiture Finish	Colore LED LED Colour
Lumen 3000K	300lm	450lm			
 10° Lens	733052._ _	733053._ _	733052._ 7	3 Grigio - Gray 6 AISI 316L Acciaio inox Stainless Steel	Y 2700K 6 3000K 9 4000K 1 5000K
 30° Lens	763052._ _	763053._ _	763052._ 7		
 60° Lens	753052._ _	753053._ _	753052._ 7		

LED COLOUR
FINISH

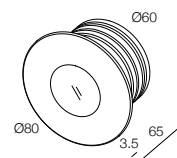

ALIMENTATORI CONSIGLIATI (non inclusi)
SUGGESTED DRIVERS (not included)

350mA **CC20-F-350-N** pag. 190
 500mA **CC20-F-500-N** pag. 192
 350mA RGB **CC36-X-350-N** pag. 200

ACCESSORI
ACCESSORIES



Controcassa
Recessed box
A00290.40











Controcassa
Recessed box
A00251.40



Micro connettore
stagno
Micro watertight
connector
A00357.40







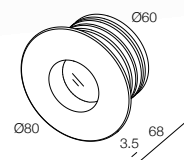

 Ø 68 mm











-  IP67
-  Class III
-  Incasso a parete, soffitto, pavimento
Wall, ceiling, floor recessed
-  Carrabile 2000 kg
Drive over up to 2000 kg
-  Cavo in neoprene 100 cm
100 cm neoprene cable
-  Installazione con controcassa consigliata
Recessed box recommended
-  Collegare in serie 350mA o 500mA
Connect in series at 350mA or 500mA
-  400 gr



NESIS H65 Am

	3W 350mA	6W 500mA	3W RGB 350mA	Finiture Finish	Colore LED LED Colour
Lumen 3000K	300lm	450lm			
 10° Lens	733542._ _	733543._ _	733542._ 7	 3 Grigio - Gray  6 AISI 316L Acciaio inox Stainless Steel	 Y 2700K  6 3000K  9 4000K  1 5000K
 30° Lens	763542._ _	763543._ _	763542._ 7		
 60° Lens	753542._ _	753543._ _	753542._ 7		
	LED COLOUR				
	FINISH				

NESIS H65 Am

CON NIDO D'APE WITH HEX LOUVER	3W 350mA	6W 500mA	3W RGB 350mA	Finiture Finish	Colore LED LED Colour
Lumen 3000K	300lm	450lm			
 10° Lens	733564._ _	733565._ _	733564._ 7	 3 Grigio - Gray  6 AISI 316L Acciaio inox Stainless Steel	 Y 2700K  6 3000K  9 4000K  1 5000K
 30° Lens	763564._ _	763565._ _	763564._ 7		
 60° Lens	753564._ _	753565._ _	753564._ 7		
	LED COLOUR				
	FINISH				

ALIMENTATORI CONSIGLIATI (non inclusi)
SUGGESTED DRIVERS (not included)

350mA **CC20-F-350-N** pag. 190
500mA **CC20-F-500-N** pag. 192
350mA RGB **CC36-X-350-N** pag. 200

ACCESSORI
ACCESSORIES



Controcassa
Recessed box
A00290.40









Controcassa
Recessed box
A00251.40



Micro connettore
stagno
Micro watertight
connector
A00357.40







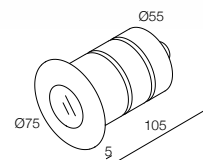







 Ø 68 mm



-  IP67
-  Class III
-  Incasso a parete, pavimento
Wall, floor recessed
-  Carrabile 2000 kg
Drive over up to 2000 kg
-  Cavo in neoprene 100 cm
100 cm neoprene cable
-  Installazione con controcassa obbligatoria
Recessed box needed
-  Collegare in serie 180mA o 250mA
Connect in series at 180mA or 250mA
-  450 gr



AURA 6-8

	6W 180mA	8W 250mA	Finiture Finish	Colore LED LED Colour
Lumen Output	600lm	800lm		
 15° Reflector	7A3443._ _	7A3446._ _	<ul style="list-style-type: none">  3 Grigio - Gray  4 Nero - Black  6 AISI 316L Acciaio inox Stainless Steel 	<ul style="list-style-type: none">  Y 2700K  6 3000K  9 4000K  1 5000K
 40° Reflector	743443._ _	743446._ _		
 Vetro satinato Frosted glass	713443._ _	713446._ _		
 15° Frangluce a nido d'ape 15° Honeycomb louver	7A3444._ _	7A3447._ _		
 15° Frangluce circolare 15° Circular louver	7A3445._ _	7A3448._ _		
 40° Frangluce a nido d'ape 40° Honeycomb louver	743444._ _	743447._ _		
 40° Frangluce circolare 40° Circular louver	743445._ _	743448._ _		

LED COLOUR
FINISH

ALIMENTATORI CONSIGLIATI (non inclusi)
SUGGESTED DRIVERS (not included)

180mA **CC20-F-180-N**
250mA **CC20-F-250-N**

pag. 188
pag. 188

ACCESSORI
ACCESSORIES





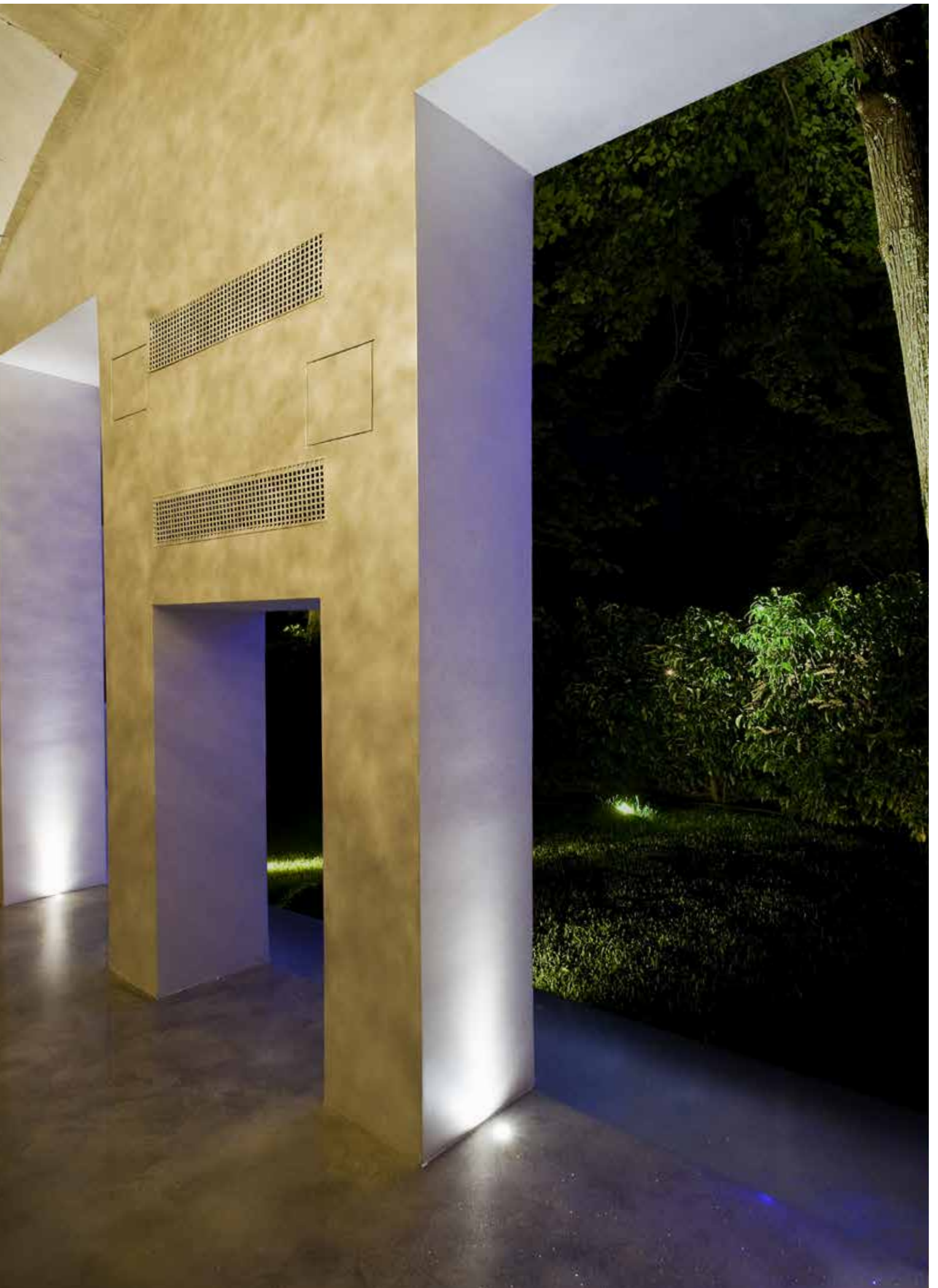



Controcassa
Recessed box
A00216.30



Connettore stagno
Watertight connector
A00387.40







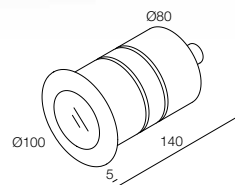









-  IP67
-  Class III
-  Incasso a parete, pavimento
Wall, floor recessed
-  Carrabile 2000 kg
Drive over up to 2000 kg
-  Installazione con controcassa obbligatoria
Recessed box needed
-  Collegare in serie 350mA
Connect in series at 350mA
-  700 gr



AURA 12

	12W 350mA	Finiture Finish	Colore LED LED Colour
Lumen Output	1400lm		
 40° Reflector	743449._ _	 3 Grigio - Gray	 Y 2700K
 Vetro satinato Frosted glass	713449._ _	 4 Nero - Black	 6 3000K
 Frangiluce a nido d'ape Honeycomb louver	723450._ _	 6 AISI 316L Acciaio inox Stainless Steel	 9 4000K
 Frangiluce circolare Circular louver	723451._ _		 1 5000K

LED COLOUR
FINISH

ALIMENTATORI CONSIGLIATI (non inclusi)
SUGGESTED DRIVERS (not included)

350mA CC20-F-350-N

pag. 190

ACCESSORI
ACCESSORIES



Controcassa
Recessed box
A00204.30



Controcassa
Recessed box
A00276.40



Connettore stagno
Watertight connector
A00387.40

 Ø 92 mm



INCASSI ORIENTABILI

ADJUSTABLE FIXTURES

300 ... 700 lm



GIOVE 3S R
page 100



GIOVE 7S R
page 101

600 ... 1500 lm



GEO 6-8 R
page 104













GEO 12 R
page 105





-  IP67
-  Class III
-  Incasso a parete, soffitto, pavimento
Wall, ceiling, floor recessed
-  Carrabile 2000 kg
Drive over up to 2000 kg
-  Cavo in neoprene 100 cm
100 cm neoprene cable
-  Installazione con controscassa obbligatoria
Recessed box needed
-  Collegare in serie 350mA
Connect in series at 350mA
-  Collegare in parallelo 24Vdc
Connect in parallel at 24Vdc
-  650 gr





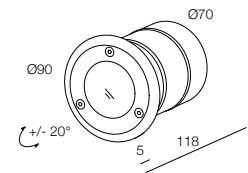





GIOVE 3S R

	3W 350mA	3W 24 Vdc	Finiture Finish	Colore LED LED Colour
Lumen 3000K	300lm	300lm		
 15° Lens	7A3170._ _	7A3171._ _	 3 Grigio - Gray	 Y 2700K
 30° Lens	763170._ _	763171._ _	 6 AISI 316L Acciaio inox Stainless Steel	 6 3000K
 60° Lens	753170._ _	753171._ _		 9 4000K
 Vetro satinato Frosted glass	713170._ _	713171._ _		 1 5000K
 Lente ellittica Elliptical lens	773170._ _	773171._ _		



LED COLOUR
FINISH

GIOVE 3S R

CON NIDO D'APE WITH HEX LOUVER	3W 350mA	3W 24 Vdc	Finiture Finish	Colore LED LED Colour
Lumen 3000K	300lm	300lm		
 15° Lens	7A3560._ _	7A3561._ _	 3 Grigio - Gray	 Y 2700K
 30° Lens	763560._ _	763561._ _	 6 AISI 316L Acciaio inox Stainless Steel	 6 3000K
 60° Lens	753560._ _	753561._ _		 9 4000K
 Vetro satinato Frosted glass	713560._ _	713561._ _		 1 5000K
 Lente ellittica Elliptical lens	773560._ _	773561._ _		

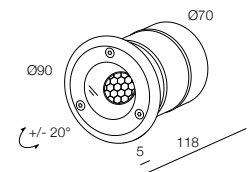

LED COLOUR
FINISH

ALIMENTATORI CONSIGLIATI (non inclusi)
SUGGESTED DRIVERS (not included)

350mA CC20-F-350-N
24 Vdc CV20-F-24-N

pag. 190
pag. 197

ACCESSORI
ACCESSORIES



Controcassa
Recessed box
A00130.40











Connettore stagno
Watertight connector
A00387.40

 Ø 76 mm



-  IP67
-  Class III
-  Incasso a parete, soffitto, pavimento
Wall, ceiling, floor recessed
-  Carrabile 2000 kg
Drive over up to 2000 kg
-  Cavo in neoprene 100 cm
100 cm neoprene cable
-  Installazione con controcassa obbligatoria
Recessed box needed
-  Collegare in serie 350mA
Connect in series at 350mA
-  Collegare in parallelo 24Vdc
Connect in parallel at 24Vdc
-  1100 gr





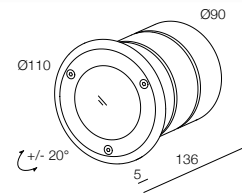





GIOVE 7S R

	7W 350mA	7W 24 Vdc	Finiture Finish	Colore LED LED Colour
Lumen 3000K	700lm	700lm		
 10° Lens	733172._ _	733173._ _	 3 Grigio - Gray  6 AISI 316L Acciaio inox Stainless Steel	 Y 2700K  6 3000K  9 4000K  1 5000K
 20° Lens	783172._ _	783173._ _		
 30° Lens	763172._ _	763173._ _		
 Vetro satinato Frosted glass	713172._ _	713173._ _		



LED COLOUR
FINISH

GIOVE 7S R

CON NIDO D'APE WITH HEX LOUVER	7W 350mA	7W 24 Vdc	Finiture Finish	Colore LED LED Colour
Lumen 3000K	700lm	700lm		
 10° Lens	733562._ _	733563._ _	 3 Grigio - Gray  6 AISI 316L Acciaio inox Stainless Steel	 Y 2700K  6 3000K  9 4000K  1 5000K
 20° Lens	783562._ _	783563._ _		
 30° Lens	763562._ _	763563._ _		
 Vetro satinato Frosted glass	713562._ _	713563._ _		

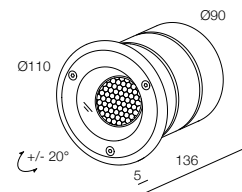

LED COLOUR
FINISH

ALIMENTATORI CONSIGLIATI (non inclusi)
SUGGESTED DRIVERS (not included)

350mA **CC20-F-350-N**
24 Vdc **CV20-F-24-N**

pag. 190
pag. 197

ACCESSORI
ACCESSORIES



Controcassa
Recessed box
A00333.40









Connettore stagno
Watertight connector
A00387.40

 Ø 98 mm









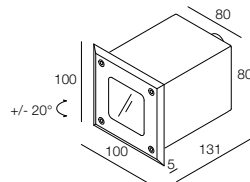





-  IP67
-  Class III
-  Incasso a parete, pavimento
Wall, floor recessed
-  Carrabile 2000 kg
Drive over up to 2000 kg
-  Installazione con controcassa obbligatoria
Recessed box needed
-  Collegare in serie 180mA o 250mA
Connect in series at 180mA or 250mA
-  1100 gr



GEO 6-8 R

	6W 180mA	8W 250mA	Finiture Finish	Colore LED LED Colour
Lumen Output	600lm	800lm		
 15° Reflector	7A3452.6 _	7A3453.6 _	 6 AISI 316L Acciaio inox Stainless Steel	 Y 2700K  6 3000K  9 4000K  1 5000K
 40° Reflector	743452.6 _	743453.6 _		
 Vetro satinato Frosted glass	713452.6 _	713453.6 _		
	LED COLOUR FINISH			

ALIMENTATORI CONSIGLIATI (non inclusi)
SUGGESTED DRIVERS (not included)

180mA CC20-F-180-N
250mA CC20-F-250-N

pag. 188
pag. 188

ACCESSORI
ACCESSORIES

Controcassa
Recessed box
A00246.30

Connettore stagno
Watertight connector
A00387.40



IP67

Class III

Incasto a parete, pavimento
Wall, floor recessed

Carrabile 2000 kg
Drive over up to 2000 kg

Installazione con controcassa obbligatoria
Recessed box needed

Collegare in serie 350mA
Connect in series at 350mA

2300 gr

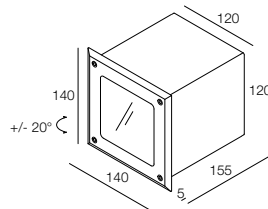

GEO 12 R

	12W 350mA	Finiture Finish	Colore LED LED Colour
Lumen Output	1500lm		
10° Reflector	733454.6 _	6 AISI 316L Acciaio inox Stainless Steel	Y 2700K 6 3000K 9 4000K 1 5000K
20° Reflector	783454.6 _		
40° Reflector	743454.6 _		
Vetro satinato Frosted glass	713454.6 _		

LED COLOUR
FINISH

ALIMENTATORI CONSIGLIATI (non inclusi)
SUGGESTED DRIVERS (not included)

ACCESSORI
ACCESSORIES

350mA CC20-F-350-N

pag. 190



Controcassa
Recessed box
A00217.30



Connettore stagno
Watertight connector
A00387.40





SEGNAPASSO CON CASSAFORMA

STEP LIGHT WITH HOUSING



100 ... 400 lm



LUI IP65
page 111



LEI IP65
page 113



RIDI
page 117

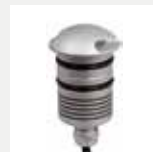

ARCO 50 iL
page 119

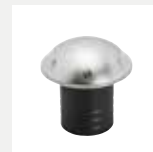

DISCOVERY
page 121









LUI IP65 01



LUI IP65 02



























LUI IP65 03

-  IP65
-  Class III
-  Incasso a parete
Wall recessed
-  Installazione con controcassa consigliata
Recessed box recommended
-  Cavo in neoprene 100 cm
100 cm neoprene cable
-  Collegare in serie 350mA o 500mA
Connect in series at 350mA or 500mA
-  150 gr



LUI IP65

	1W 350mA	2W 500mA	Finiture Finish	Colore LED LED Colour
Lumen 3000K	100lm	150lm		
 45° Emission	723485._._	723486._._	<ul style="list-style-type: none">  3 Grigio - Gray  4 Nero - Black  6 AISI 316L Acciaio inox Stainless Steel 	<ul style="list-style-type: none">  Y 2700K  6 3000K  9 4000K  1 5000K
 45° Emission	723487._._	723488._._	<ul style="list-style-type: none">  3 Grigio - Gray  4 Nero - Black  6 AISI 316L Acciaio inox Stainless Steel 	<ul style="list-style-type: none">  Y 2700K  6 3000K  9 4000K  1 5000K
 45° Emission	723489._._	723490._._	<ul style="list-style-type: none">  3 Grigio - Gray  4 Nero - Black  6 AISI 316L Acciaio inox Stainless Steel 	<ul style="list-style-type: none">  Y 2700K  6 3000K  9 4000K  1 5000K

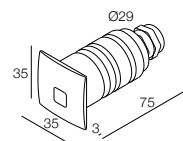

LUI IP65 01

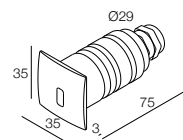

LUI IP65 02

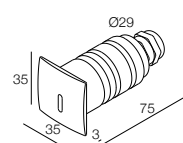

LUI IP65 03

LED COLOUR
FINISH

ALIMENTATORI CONSIGLIATI (non inclusi)
SUGGESTED DRIVERS (not included)

ACCESSORI
ACCESSORIES

350mA **CC20-F-350-N**
500mA **CC20-F-500-N**

pag. 190
pag. 192



Controcassa
Recessed box
A00161.30



Controcassa
Recessed box
A00249.40



Connettore stagno
Watertight connector
A00387.40

 Ø 40 mm









LEI IP65 01



LEI IP65 02



























LEI IP65 03

-  IP65
-  Class III
-  Incasso a parete
Wall recessed
-  Installazione con controcassa consigliata
Recessed box recommended
-  Cavo in neoprene 100 cm
100 cm neoprene cable
-  Collegare in serie 350mA o 500mA
Connect in series at 350mA or 500mA
-  150 gr



LEI IP65

	1W 350mA	2W 500mA	Finiture Finish	Colore LED LED Colour
Lumen 3000K	100lm	150lm		
 45° Emission	723479._._	723480._._	<ul style="list-style-type: none">  3 Grigio - Gray  4 Nero - Black  6 AISI 316L Acciaio inox Stainless Steel 	<ul style="list-style-type: none">  Y 2700K  6 3000K  9 4000K  1 5000K
 45° Emission	723481._._	723482._._	<ul style="list-style-type: none">  3 Grigio - Gray  4 Nero - Black  6 AISI 316L Acciaio inox Stainless Steel 	<ul style="list-style-type: none">  Y 2700K  6 3000K  9 4000K  1 5000K
 45° Emission	723483._._	723484._._	<ul style="list-style-type: none">  3 Grigio - Gray  4 Nero - Black  6 AISI 316L Acciaio inox Stainless Steel 	<ul style="list-style-type: none">  Y 2700K  6 3000K  9 4000K  1 5000K

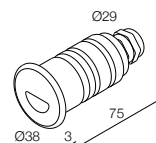

LEI IP65 01

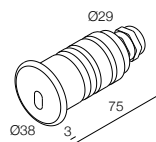

LEI IP65 02

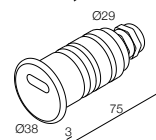

LEI IP65 03

LED COLOUR
FINISH

ALIMENTATORI CONSIGLIATI (non inclusi)
SUGGESTED DRIVERS (not included)

350mA **CC20-F-350-N**
500mA **CC20-F-500-N**

pag. 190
pag. 192

ACCESSORI
ACCESSORIES



Controcassa
Recessed box
A00161.30



Controcassa
Recessed box
A00249.40



Connettore stagno
Watertight connector
A00387.40

 Ø 40 mm



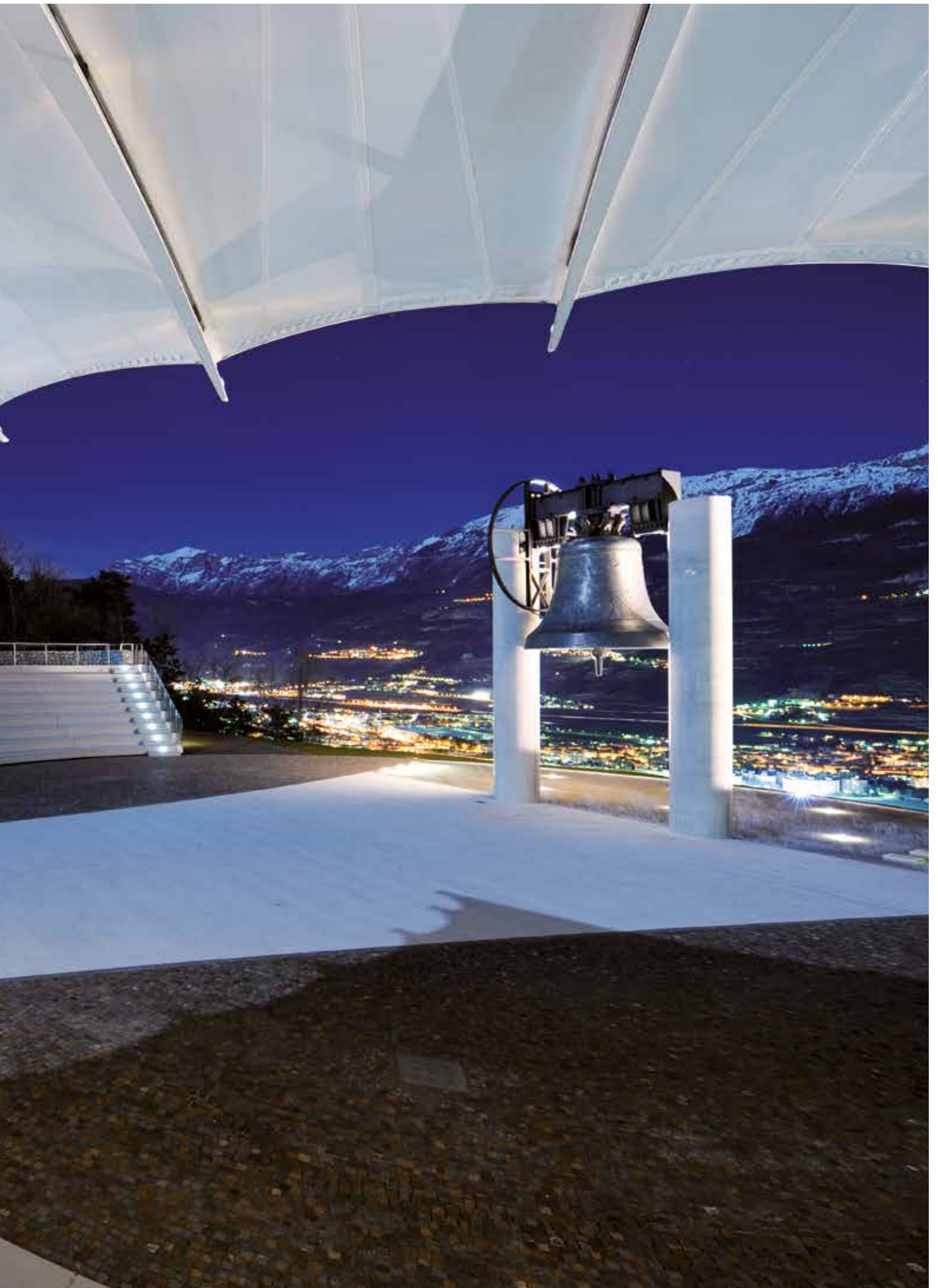









116

RIDI









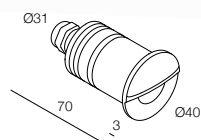



AISI 316L
ACCIAIO INOX
AISI 316L STAINLESS STEEL



-  **IP67**
-  **Class III**
-  **Incasto a parete, soffitto, pavimento**
Wall, ceiling, floor recessed
-  **Cavo in neoprene 100 cm**
100 cm neoprene cable
-  **Installazione con controcassa consigliata**
Recessed box recommended
-  **Collegare in serie 350mA o 500mA**
Connect in series at 350mA or 500mA
-  **100 gr**



RIDI

	1W 350mA	2W 500mA	Finiture Finish	Colore LED LED Colour
Lumen 3000K	100lm	150lm		
 10° Lens	733510._ _	733511._ _	<ul style="list-style-type: none">  3 Grigio - Gray  4 Nero - Black  6 AISI 316L Acciaio inox Stainless Steel  B Bronzo Scuro Dark bronze 	<ul style="list-style-type: none">  Y 2700K  6 3000K  9 4000K  1 5000K
 30° Lens	763510._ _	763511._ _		
 40° Lens	743510._ _	743511._ _		

LED COLOUR
FINISH

ALIMENTATORI CONSIGLIATI (non inclusi)
SUGGESTED DRIVERS (not included)

350mA **CC20-F-350-N**
500mA **CC20-F-500-N**

pag. 190
pag. 192

ACCESSORI
ACCESSORIES



Controcassa
Recessed box
A00409.40



Micro connettore
stagno
Micro watertight
connector
A00357.40

 Ø 37 mm



Mono emissione
Single light emission



Bi emissione
Double light emission



Tripla emissione
Triple light emission

-  IP67
-  Class III
-  Incasso a parete, pavimento
Wall, floor recessed
-  Calpestabile
Steppable
-  Cavo in neoprene 100 cm
100 cm neoprene cable
-  Installazione con controscassa consigliata
Recessed box recommended
-  Collegare in serie 350mA o 500mA
Connect in series at 350mA or 500mA
-  Collegare in parallelo 24Vdc
Connect in parallel at 24Vdc
-  250 gr



ARCO 50 IL

	1W 350mA	1W 24 Vdc	2W 500mA	2W 24 Vdc	Finiture Finish	Colore LED LED Colour
Lumen 3000K	100lm	100lm	150lm	150lm		
 Mono emissione Single light emission	703216._._	703225._._	703217._._	703226._._	■ 3 Grigio - Gray ■ 4 Nero - Black ■ T Titanio - Titanium	■ Y 2700K ■ 6 3000K ■ 9 4000K ■ 1 5000K
	LED COLOUR					
	FINISH					

MONO EMISSIONE

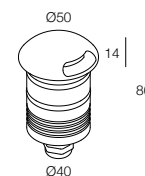

	1W x2 350mA	1W x2 24 Vdc	2W x2 500mA	2W x2 24 Vdc	Finiture Finish	Colore LED LED Colour
Lumen 3000K	100lm x 2	100lm x 2	150lm x 2	150lm x 2		
 Bi emissione Double light emission	703214._._	703223._._	703215._._	703224._._	■ 3 Grigio - Gray ■ 4 Nero - Black ■ T Titanio - Titanium	■ Y 2700K ■ 6 3000K ■ 9 4000K ■ 1 5000K
	LED COLOUR					
	FINISH					

BI EMISSIONE

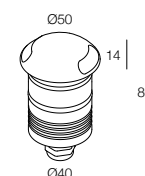

	1W x3 350mA	1W x3 24 Vdc	2W x3 500mA	2W x3 24 Vdc	Finiture Finish	Colore LED LED Colour
Lumen 3000K	100lm x 3	100lm x 3	150lm x 3	150lm x 3		
 Tripla emissione Triple light emission	703212._._	703221._._	703213._._	703222._._	■ 3 Grigio - Gray ■ 4 Nero - Black ■ T Titanio - Titanium	■ Y 2700K ■ 6 3000K ■ 9 4000K ■ 1 5000K
	LED COLOUR					
	FINISH					

TRIPLA EMISSIONE

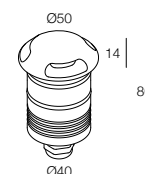

ALIMENTATORI CONSIGLIATI (non inclusi)
SUGGESTED DRIVERS (not included)

ACCESSORI
ACCESSORIES

350mA CC20-F-350-N pag. 190
500mA CC20-F-500-N pag. 192
24 Vdc CV20-F-24-N pag. 197



Controcassa
Recessed box
A00129.30



Controcassa
Recessed box
A00250.40



Connettore stagno
Watertight connector
A00387.40

 Ø 50 mm



Mono emissione
Single light emission



Bi emissione
Double light emission











Tripla emissione
Triple light emission

-  IP65
-  Class III
-  Incasto a parete, pavimento
Wall, floor recessed
-  Carrabile 2000 kg
Drive over up to 2000 kg
-  Cavo in neoprene 100 cm
100 cm neoprene cable
-  Installazione con controcassa obbligatoria
Recessed box needed
-  Collegare in serie 350mA
Connect in series at 350mA
-  Collegare in parallelo 24Vdc
Connect in parallel at 24Vdc
-  1100 gr









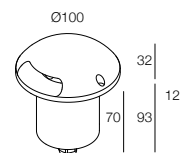

DISCOVERY

	4W 350mA	4W 24 Vdc	Finiture Finish	Colore LED LED Colour
Lumen Output	400lm	400lm		
 Vetro trasparente Transparent glass	723637._ _	723638._ _	<ul style="list-style-type: none">  3 Grigio - Gray  4 Nero - Black  6 AISI 316L Acciaio inox Stainless Steel 	<ul style="list-style-type: none">  Y 2700K  6 3000K  9 4000K  1 5000K
 Vetro satinato Frosted glass	713637._ _	713638._ _		
	LED COLOUR FINISH			







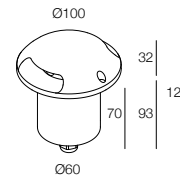

MONO EMISSIONE



	4W x 2 350mA	4W x 2 24 Vdc	Finiture Finish	Colore LED LED Colour
Lumen Output	400lm x 2	400lm x 2		
 Vetro trasparente Transparent glass	723639._ _	723640._ _	<ul style="list-style-type: none">  3 Grigio - Gray  4 Nero - Black  6 AISI 316L Acciaio inox Stainless Steel 	<ul style="list-style-type: none">  Y 2700K  6 3000K  9 4000K  1 5000K
 Vetro satinato Frosted glass	713639._ _	713640._ _		
	LED COLOUR FINISH			

BI EMISSIONE



	4W x 3 350mA	4W x 3 24 Vdc	Finiture Finish	Colore LED LED Colour
Lumen Output	400lm x 3	400lm x 3		
 Vetro trasparente Transparent glass	723641._ _	723642._ _	<ul style="list-style-type: none">  3 Grigio - Gray  4 Nero - Black  6 AISI 316L Acciaio inox Stainless Steel 	<ul style="list-style-type: none">  Y 2700K  6 3000K  9 4000K  1 5000K
 Vetro satinato Frosted glass	713641._ _	713642._ _		
	LED COLOUR FINISH			

TRIPLA EMISSIONE

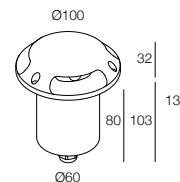

ALIMENTATORI CONSIGLIATI (non inclusi)
SUGGESTED DRIVERS (not included)

ACCESSORI
ACCESSORIES

350mA **CC20-F-350-N** pag. 190
24 Vdc **CV20-F-24-N** pag. 197



Controcassa
Recessed box
A00468.40



Connettore stagno
Watertight connector
A00387.40

 Ø 96 mm

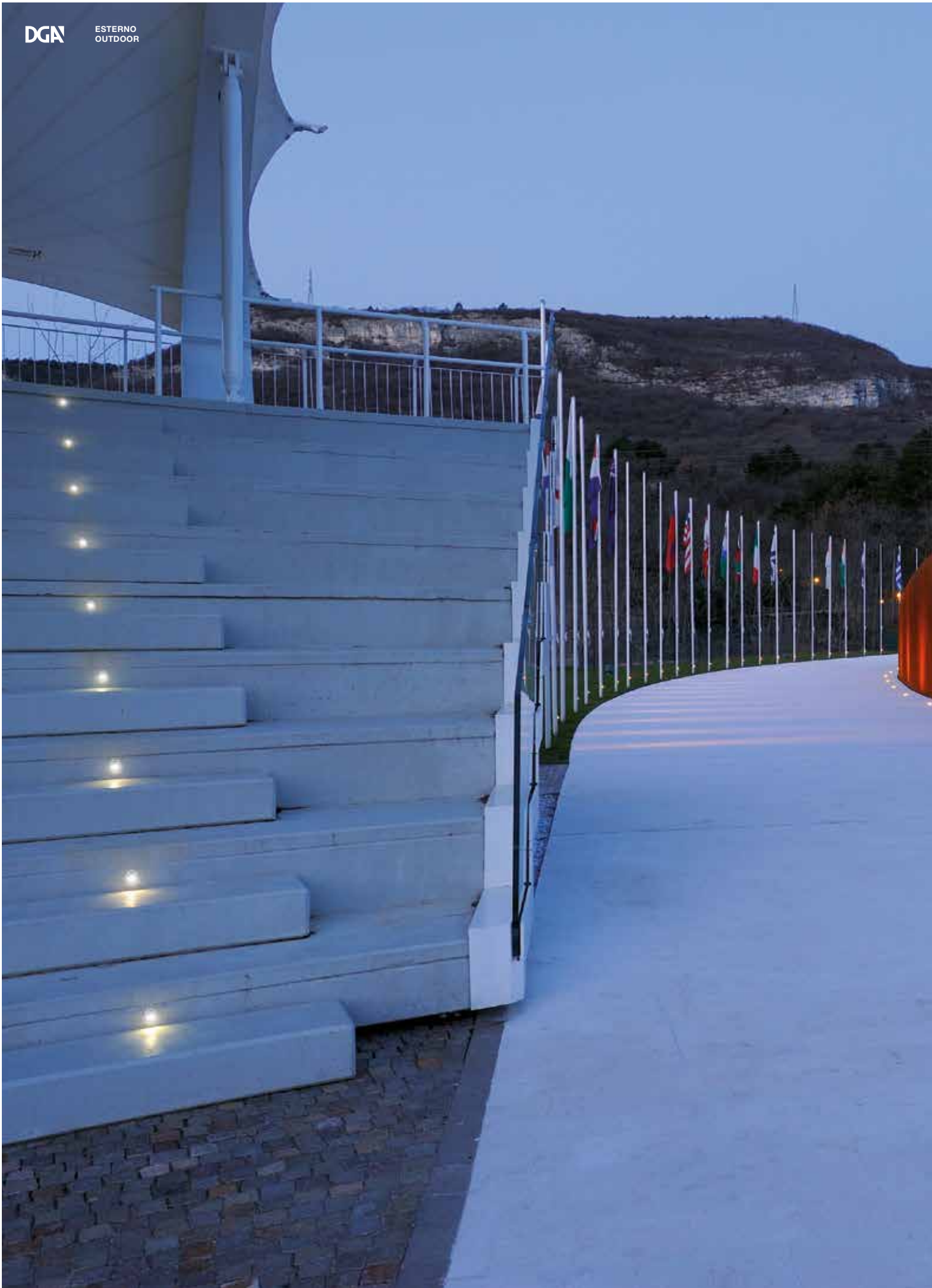

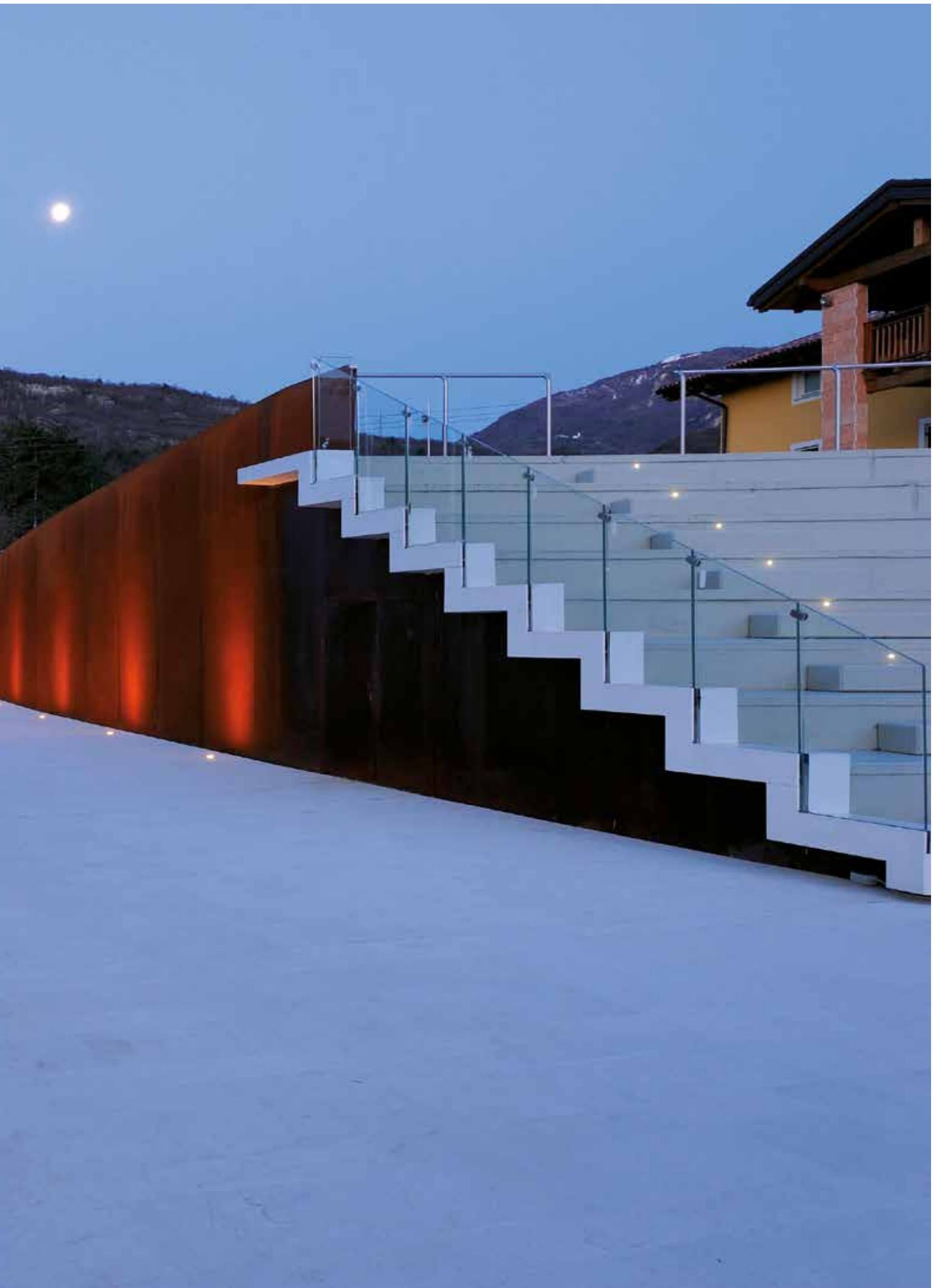

INCASSI CON CASSAFORMA

FIXTURES WITH HOUSING

IP68



100 ... 1050 lm



GEMMA 20 IP68
page 127



GEMMA 35 IP68
page 128



ARCO 60 IP68
page 131



NESIS H65 IP68
page 133



ARCO 80 IP68
page 134









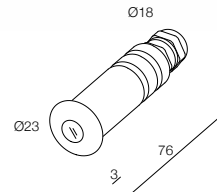



-  IP68
-  Class III
-  Incasso a parete, pavimento
Wall, floor recessed
-  Cavo in neoprene 100 cm
100 cm neoprene cable
-  Collegare in serie 350mA o 500mA
Connect in series at 350mA or 500mA
-  110 gr



GEMMA 20 IP68

	1W 350mA	2W 500mA	Finiture Finish	Colore LED LED Colour
Lumen 3000K	100lm	150lm		
 Vetro trasparente Transparent glass	723042.6 _	723043.6 _	 6 AISI 316L Acciaio inox Stainless Steel	 Y 2700K  6 3000K  9 4000K  1 5000K
 Vetro satinato Frosted glass	713042.6 _	713043.6 _		

LED COLOUR
FINISH

ALIMENTATORI CONSIGLIATI (non inclusi)
SUGGESTED DRIVERS (not included)

350mA **CC20-F-350-N**
500mA **CC20-F-500-N**

pag. 190
pag. 192

ACCESSORI
ACCESSORIES



Controcassa
Recessed box
A00285.40



Controcassa
Recessed box
A00326.40





Micro connettore
stagno
Micro watertight
connector
A00357.40

 Ø 23 mm

 IP68

 Class III

 Incasso a parete, pavimento
Wall, floor recessed

 Possibilità di scelta tra 6 differenti ottiche
Available in 6 different optics







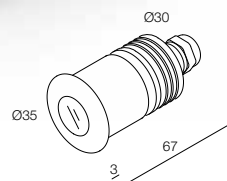



 Cavo in neoprene 100 cm
100 cm neoprene cable

 Collegare in serie 350mA o 500mA
Connect in series at 350mA or 500mA

 200 gr



GEMMA 35 IP68

	1W 350mA	2W 500mA	3W 350mA	Finiture Finish	Colore LED LED Colour
Lumen 3000K	100lm	150lm	300lm		
 10° Lens	730920.6 _	730921.6 _		 6 AISI 316L Acciaio inox Stainless Steel	 Y 2700K  6 3000K  9 4000K  1 5000K
 30° Lens	760920.6 _	760921.6 _			
 40° Lens	740920.6 _	740921.6 _			
 Vetro trasparente Transparent glass	720920.6 _	720921.6 _	720922.6 _		
 Vetro satinato Frosted glass	710920.6 _	710921.6 _	710922.6 _		
 Lente ellittica Elliptical lens	770920.6 _	770921.6 _			

LED COLOUR
FINISH

ALIMENTATORI CONSIGLIATI (non inclusi)
SUGGESTED DRIVERS (not included)

ACCESSORI
ACCESSORIES

350mA **CC20-F-350-N**
500mA **CC20-F-500-N**

pag. 190
pag. 192



Controcassa
Recessed box
A00231.30



Controcassa
Recessed box
A00249.40



Micro connettore
stagno
Micro watertight
connector
A00357.40

 Ø 40 mm



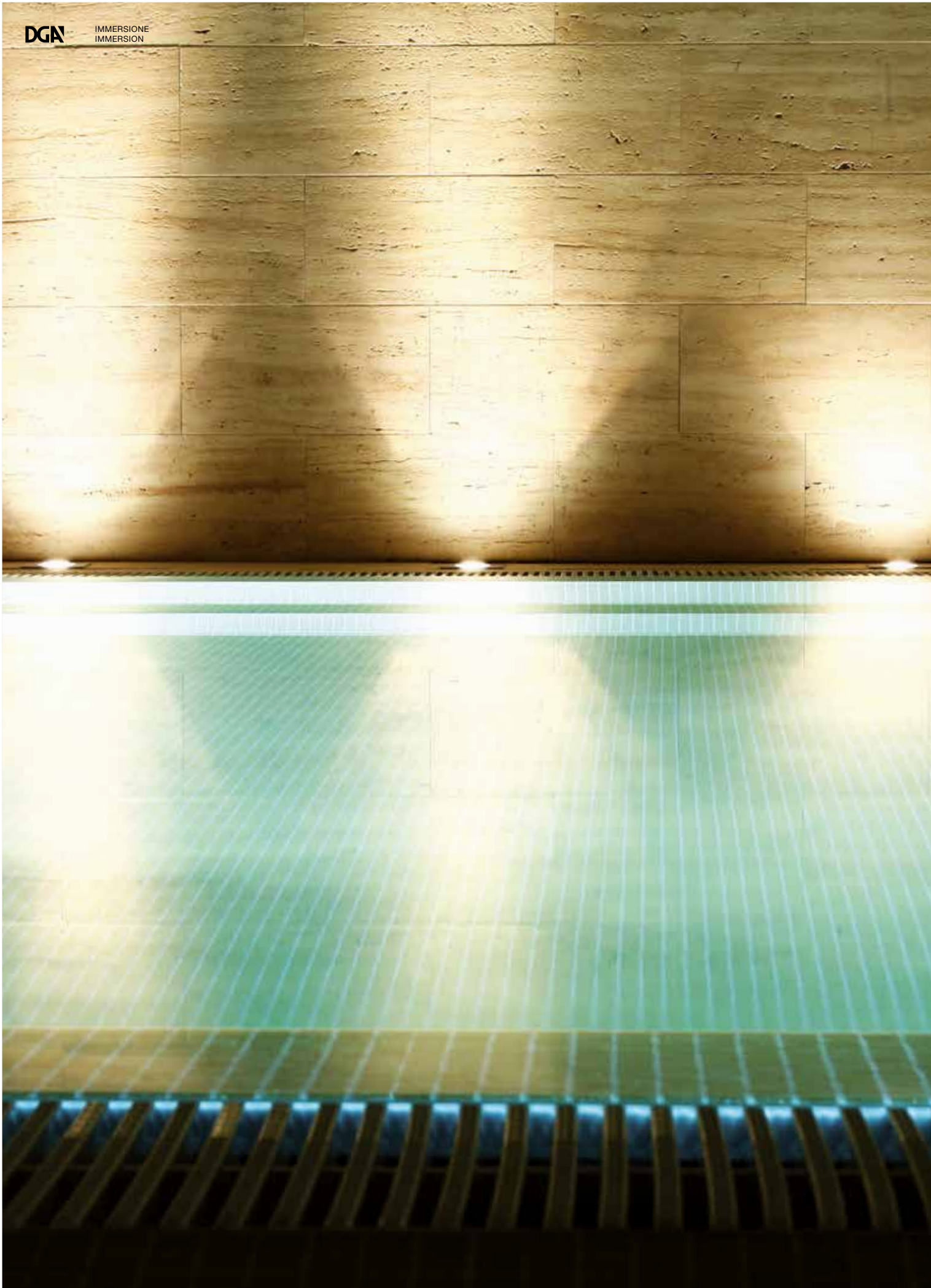





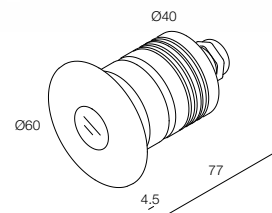







-  IP68
-  Class III
-  Incasso a parete, pavimento
Wall, floor recessed
-  Cavo in neoprene 100 cm
100 cm neoprene cable
-  Collegare in serie 350mA o 500mA
Connect in series at 350mA or 500mA
-  Collegare in parallelo 12Vdc
Connect in parallel at 12Vdc
-  420 gr



ARCO 60 IP68

Usare solo in immersione permanente
Use only in permanent immersion

	3W 350mA	3W 12 Vdc	3W RGB 350mA	6W 500mA	6W 12 Vdc	Finiture Finish	Colore LED LED Colour
Lumen 3000K	300lm	300lm		450lm	450lm		
 15° Lens	7A0790.6 _	7A3805.6 _		7A0834.6 _	7A3806.6 _	 6 AISI 316L Acciaio inox Stainless Steel	 Y 2700K  6 3000K  9 4000K  1 5000K
 30° Lens	760790.6 _	763805.6 _	760790.6 7	760834.6 _	763806.6 _		
 60° Lens	750790.6 _	753805.6 _		750834.6 _	753806.6 _		
 Vetro satinato Frosted glass	710791.6 _	713805.6 _	710791.6 7	710835.6 _	713806.6 _		
 Lente ellittica Elliptical lens	770790.6 _	773805.6 _		770834.6 _	773806.6 _		

LED COLOUR
FINISH

ALIMENTATORI CONSIGLIATI (non inclusi)
SUGGESTED DRIVERS (not included)

350mA **CC20-F-350-N** pag. 190
500mA **CC20-F-500-N** pag. 192
350mA RGB **CC36-X-350-N** pag. 200
12 Vdc **CV20-F-12-N** pag. 197

ACCESSORI
ACCESSORIES



Controcassa
Recessed box
A00230.30



Controcassa
Recessed box
A00250.40



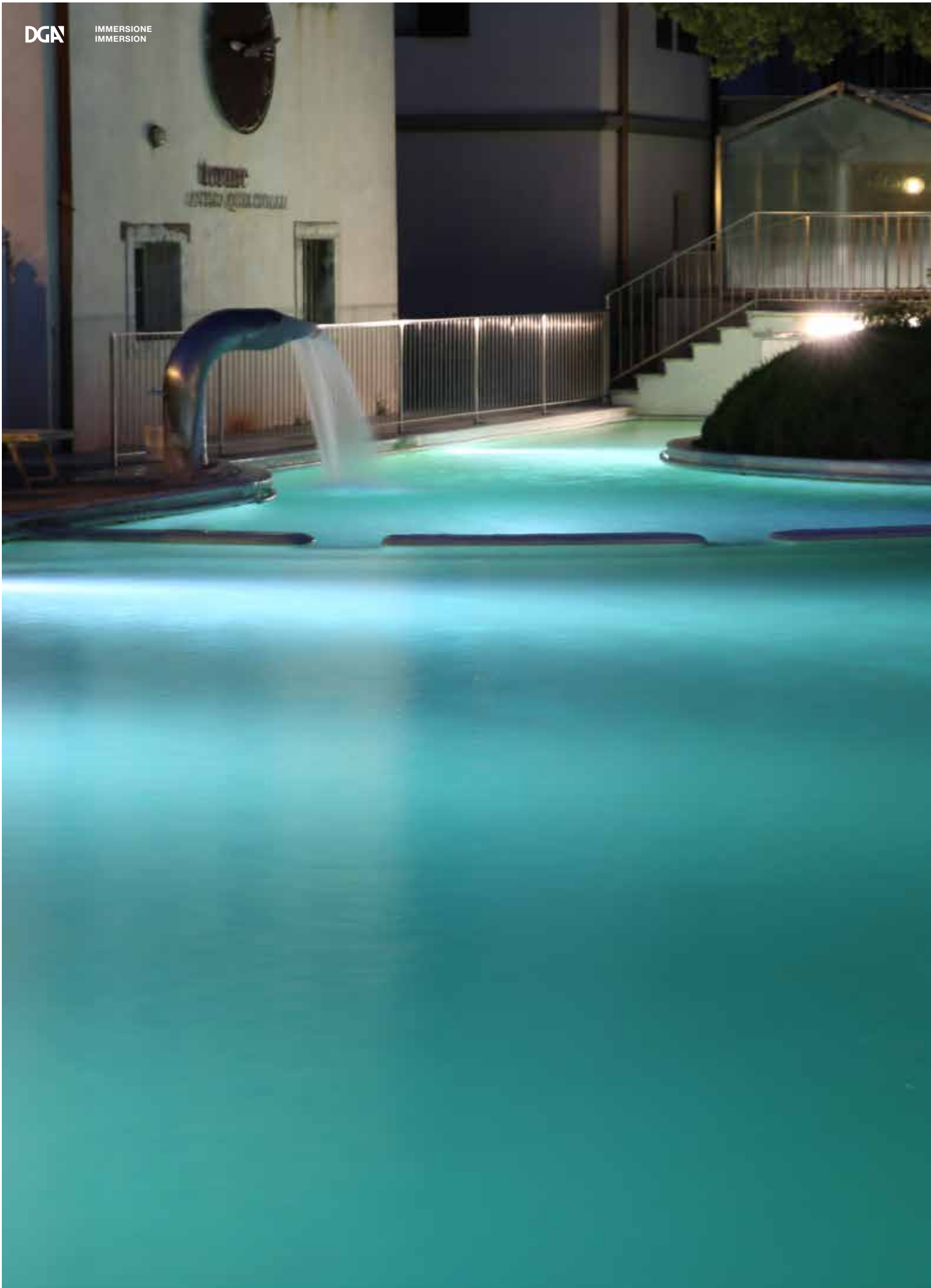

Connettore stagno
Watertight connector
A00387.40

 Ø 50 mm







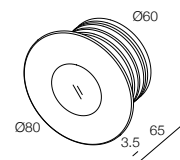





-  IP68
-  Class III
-  Incasso a parete, pavimento
Wall, floor recessed
-  Cavo in neoprene 100 cm
100 cm neoprene cable
-  Collegare in serie 350mA o 500mA
Connect in series at 350mA or 500mA
-  770 gr



NESIS H65 IP68

	3W 350mA	3W RGB 350mA	6W 500mA	Finiture Finish	Colore LED LED Colour
Lumen 3000K	300lm		450lm		
 10° Lens	733054.6 _	733054.6 7	733055.6 _	 6 AISI 316L Acciaio inox Stainless Steel	 Y 2700K  6 3000K  9 4000K  1 5000K
 30° Lens	763054.6 _	763054.6 7	763055.6 _		
 60° Lens	753054.6 _	753054.6 7	753055.6 _		

LED COLOUR
FINISH

ALIMENTATORI CONSIGLIATI (non inclusi)
SUGGESTED DRIVERS (not included)

350mA **CC20-F-350-N** pag. 190
500mA **CC20-F-500-N** pag. 192
350mA RGB **CC36-X-350-N** pag. 200

ACCESSORI
ACCESSORIES







Controcassa
Recessed box
A00290.40



Controcassa
Recessed box
A00251.40

Micro connettore
stagno
Micro watertight
connector
A00357.40

 Ø 68 mm



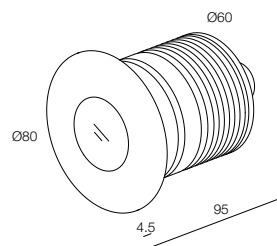







-  IP68
-  Class III
-  Incasso a parete, pavimento
Wall, floor recessed
-  Cavo in neoprene 100 cm
100 cm neoprene cable
-  Collegare in parallelo 12Vdc
Connect in parallel at 12Vdc
-  1070 gr



ARCO 80 IP68

Usare solo in immersione permanente
Use only in permanent immersion

Lumen 3000K	7W 12 Vdc 700lm	10W 12 Vdc 1050lm	Finiture Finish	Colore LED LED Colour
 10° Lens	733813.6 _	733814.6 _	 6 AISI 316L Acciaio inox Stainless Steel	 Y 2700K
 20° Lens	783813.6 _	783814.6 _		 6 3000K
 30° Lens	763813.6 _	763814.6 _		 9 4000K
 Vetro satinato Frosted glass	713813.6 _	713814.6 _		 1 5000K

LED COLOUR
FINISH

ALIMENTATORI CONSIGLIATI (non inclusi)
SUGGESTED DRIVERS (not included)

12 Vdc

CV20-F-12-N

pag. 199

ACCESSORI
ACCESSORIES



Controcassa
Recessed box
A00243.40



Controcassa
Recessed box
A00251.40





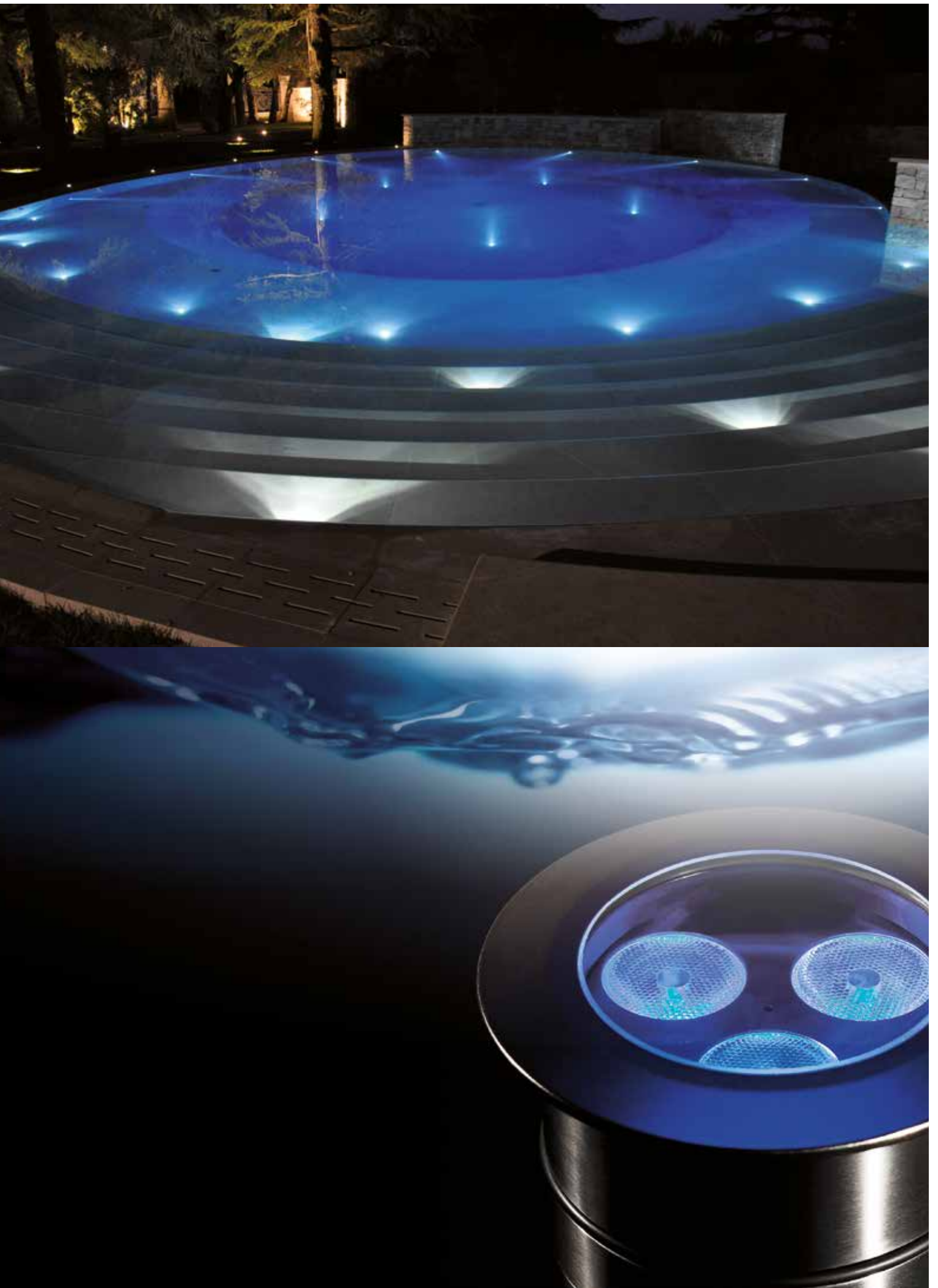

Connettore stagno
Watertight connector
A00387.40

 Ø 73 mm







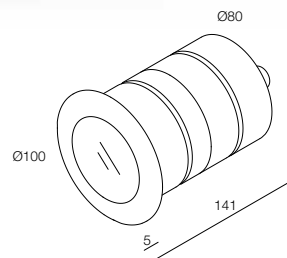



-  IP68
-  Class III
-  Incasso a parete, pavimento
Wall, floor recessed
-  Installazione con controccassa obbligatoria
Recessed box needed
-  Fornito con cavi uscenti in neoprene L=100cm
Provided with outgoing neoprene cables L=100cm
24V - DMX in - DMX out
-  Collegare in parallelo 24Vdc
Connect in parallel at 24Vdc
-  2300 gr



IRIDE 3 IP68 i □

	ALL WHITE Controller DMX 20W 24 Vdc	DYNAMIC WHITE Controller DMX 20W 24 Vdc	RGBW - DMX Controller DMX 20W 24 Vdc	Finiture Finish	Colore LED LED Colour
 30° Lens	760628.6 _	760628.6 8	763382.6 7	 6 AISI 316L Acciaio inox Stainless Steel	 Y 2700K  6 3000K  9 4000K  1 5000K
 60° Lens	750628.6 _	750628.6 8	753382.6 7		



ALIMENTATORI CONSIGLIATI (non inclusi)
SUGGESTED DRIVERS (not included)

24 Vdc **CV70-F-24-N**
Controller DMX

pag. 197

pag. 204

ACCESSORI
ACCESSORIES



Controcassa
Recessed box
A00276.40

 Ø 92 mm



IP68

Class III

Montaggio a parete, pavimento
Wall, floor mounting

Installazione con controcassa obbligatoria
Recessed box needed

Fornito con cavi uscenti in neoprene L=100cm
Provided with outgoing neoprene cables L=100cm
24V – DMX in – DMX out

Collegare in parallelo 24Vdc
Connect in parallel at 24Vdc

2800 gr

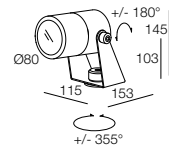

IRIDE 3 IP68 P

ALL WHITE
Controller DMX
20W
24 Vdc

DYNAMIC WHITE
Controller DMX
20W
24 Vdc

RGBW - DMX
Controller DMX
20W
24 Vdc

Finiture
Finish

Colore LED
LED Colour

30° Lens

760591.6 _

760591.6 8

763384.6 7

6 AISI 316L
Acciaio inox
Stainless Steel

Y 2700K

6 3000K

9 4000K

1 5000K

60° Lens

750591.6 _

750591.6 8

753384.6 7

LED COLOUR

FINISH

ALIMENTATORI CONSIGLIATI (non inclusi)
SUGGESTED DRIVERS (not included)

24 Vdc CV70-F-24-N pag. 197
24 Vdc CV70-F-24-P pag. 197

Controller DMX pag. 204



PROIETTORI ORIENTABILI

ADJUSTABLE SPOTLIGHTS

300 lm

MICRO
page 140

1500 ... 2000 lm

MICRO IP68
page 141

600 ... 2000 lm

QUANTUM P
page 145SIRIO 6 Evo
page 149SIRIO 9 Evo
page 150SIRIO 12 Evo
page 151SIRIO 20 Evo
page 153



DESIGN, EFFICIENZA
E FLESSIBILITÀ





DESIGN, EFFICACY
AND FLEXIBILITY









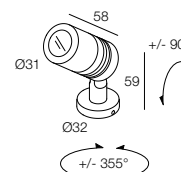

-  IP67
-  Class III 350mA
-  Class II 220-240Vac
-  Montaggio a parete, soffitto, pavimento
Wall, ceiling, floor mounting
-  Cavo in neoprene 100 cm
100 cm neoprene cable
-  Collegare in serie 350mA
Connect in series at 350mA
-  Alimentazione integrata
Built-in driver
-  190 gr

MICRO

	3W 350mA	Finiture Finish	Colore LED LED Colour
Lumen 3000K	300lm		
 15° Lens	7A0833._ _	<input type="checkbox"/> 3 Grigio - Gray <input type="checkbox"/> 4 Nero - Black <input type="checkbox"/> E Ottone integrale Completely made of brass	<input type="checkbox"/> Y 2700K <input type="checkbox"/> 6 3000K <input type="checkbox"/> 9 4000K <input type="checkbox"/> 1 5000K
 30° Lens	760833._ _		
 60° Lens	750833._ _		
 Vetro satinato Frosted glass	710832._ _		
 Lente ellittica Elliptical lens	770833._ _		
		LED COLOUR FINISH	



MICRO

	3W 220-240 Vac	Finiture Finish	Colore LED LED Colour
Lumen 3000K	300lm		
 15° Lens	7A3056._ _	<input type="checkbox"/> 3 Grigio - Gray <input type="checkbox"/> 4 Nero - Black <input type="checkbox"/> E Ottone integrale Completely made of brass	<input type="checkbox"/> Y 2700K <input type="checkbox"/> 6 3000K <input type="checkbox"/> 9 4000K <input type="checkbox"/> 1 5000K
 30° Lens	763056._ _		
 60° Lens	753056._ _		
 Vetro satinato Frosted glass	713057._ _		
 Lente ellittica Elliptical lens	773056._ _		
		LED COLOUR FINISH	

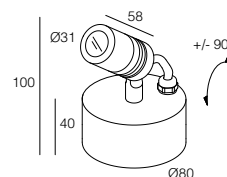

ALIMENTATORI CONSIGLIATI (non inclusi)
SUGGESTED DRIVERS (not included)

ACCESSORI
ACCESSORIES

350mA CC20-F-350-N
350mA CC6-F-350-P

pag. 190
pag. 190

Picchetto in Acciaio
Inox AISI 316L
Stainless Steel stake
A00277.60









Visiera antiabbagliamento
Low glare visor
A00323_0
FINISH



Micro connettore
stagno
Micro watertight
connector
A00357.40





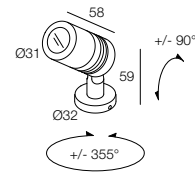

GRADO DI PROTEZIONE IP68 PROTECTION RATING



-  IP68
-  Class III
-  Montaggio a parete, pavimento
Wall, floor mounting
-  Cavo in neoprene 500 cm
500 cm neoprene cable
-  316L In acciaio, idoneo per ambienti aggressivi o salmastri
Suitable in stainless steel for aggressive or salty environments
-  Collegare in serie 350mA
Connect in series at 350mA
-  280 gr



MICRO IP68

	3W 350mA	300lm	Finiture Finish	Colore LED LED Colour
Lumen 3000K				
 15° Lens	7A0837.6 _		6 AISI 316L Acciaio inox Stainless Steel	Y 2700K 6 3000K 9 4000K 1 5000K
 30° Lens	760837.6 _			
 60° Lens	750837.6 _			
 Vetro satinato Frosted glass	710836.6 _			
 Lente ellittica Elliptical lens	770837.6 _			

LED COLOUR	
FINISH	

ALIMENTATORI CONSIGLIATI (non inclusi)
SUGGESTED DRIVERS (not included)

350mA **CC20-F-350-N**
350mA **CC6-F-350-P**

pag. 190
pag. 190

ACCESSORI
ACCESSORIES



Picchetto in Acciaio
Inox AISI 316L
Stainless Steel stake
A00277.60



Visiera antiabbagliamento
Low glare visor
A00323.60 Acciaio Inox
Stainless Steel



Micro connettore
stagno
Micro watertight
connector
A00357.40



QUANTUM P

UN PASSO AVANTI NELL'ILLUMINAZIONE
A LED PER ESTERNI

ONE STEP AHEAD
IN OUTDOOR LED LIGHTING

Tre diverse aperture del fascio
Three different beam angles are available

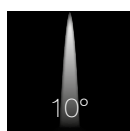

10°

Narrow

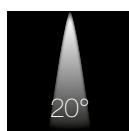

20°

Medium

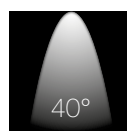

40°

Large

12W 350mA
1500 lumen
output

18W 500mA
2000 lumen
output

Sistema di dissipazione brevettato DGA

Patented heat dissipation system

Ottica ad alto rendimento

High performing optic



Filtri intercambiabili

Interchangeable filters



Filtro Ellittico
Linear Spread



Nido D'ape
Hex Louver



Filtro Prismatico
Prismatic Spread



Filtro Correttivo
Softening Lens



ACCESSORI
ACCESSORIES



Filtro Ellittico
Linear Spread
A00416. _ 0
Only for 20°
reflector



Nido D'ape
Hex Louver
A00417. _ 0



Filtro Prismatico
Prismatic Spread
A00418. _ 0



Filtro Correttivo
Softening Lens
A00419. _ 0



Picchetto in
acciaio Inox AISI 316L
Stainless Steel
316L stake
A00281.60







Visiera
antiabbagliamento
Low glare visor
A00420. _ 0



Connettore stagno
Watertight connector
A00387.40











FINISH

FINISH

-  IP67
-  Class III 350mA - 500mA - 24 Vdc
-  Class II 220-240Vac
-  Montaggio a parete, soffitto, pavimento
Wall, ceiling, floor mounting
-  Cavo in neoprene 100 cm
100 cm neoprene cable
-  Alimentazione integrata
Built-in driver
-  680 gr



QUANTUMP







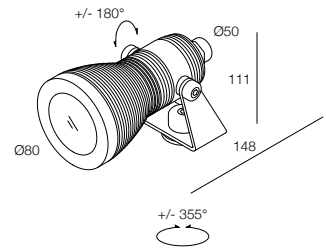



	12W 350mA	18W 500mA	Finiture Finish	Colore LED LED Colour
Lumen Output	1500lm	2000lm		
 10° Reflector	733322._ _	733323._ _	 3 Grigio - Gray	 Y 2700K
 20° Reflector	783322._ _	783323._ _	 4 Nero - Black	 6 3000K
 40° Reflector	743322._ _	743323._ _	 T Titanio - Titanium	 W 3000K CRI > 90
				 9 4000K
				 1 5000K

LED COLOUR

FINISH



QUANTUMP







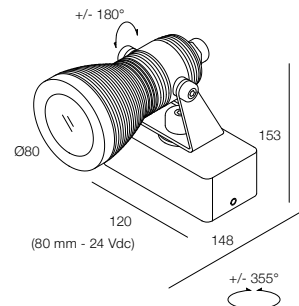



	12W 24 Vdc	18W 24 Vdc	Finiture Finish	Colore LED LED Colour
Lumen Output	1500lm	2000lm		
 10° Reflector	733477._ _	733478._ _	 3 Grigio - Gray	 Y 2700K
 20° Reflector	783477._ _	783478._ _	 4 Nero - Black	 6 3000K
 40° Reflector	743477._ _	743478._ _	 T Titanio - Titanium	 W 3000K CRI > 90
				 9 4000K
				 1 5000K

LED COLOUR

FINISH



QUANTUMP

	12W 220-240 Vac	18W 220-240 Vac	Finiture Finish	Colore LED LED Colour
Lumen Output	1500lm	2000lm		
 10° Reflector	733474._ _	733475._ _	 3 Grigio - Gray	 Y 2700K
 20° Reflector	783474._ _	783475._ _	 4 Nero - Black	 6 3000K
 40° Reflector	743474._ _	743475._ _	 T Titanio - Titanium	 W 3000K CRI > 90
				 9 4000K
				 1 5000K

LED COLOUR

FINISH

ALIMENTATORI CONSIGLIATI (non inclusi)
SUGGESTED DRIVERS (not included)

350mA	CC20-F-350-N	pag. 190
500mA	CC20-F-500-N	pag. 192
24 Vdc	CV20-F-24-N	pag. 197



PROIETTORI ORIENTABILI

ADJUSTABLE SPOTLIGHTS



PONTE VECCHIO A FIRENZE

Per l'illuminazione del Ponte Vecchio-Firenze è stata realizzata una versione speciale dei proiettori per esterni Quantum P.

Per poter integrare al meglio gli apparecchi nel contesto è stata prevista una finitura custom con un colore (Bronzo scuro) ottenuto tramite ossidazione anodica a forte spessore.

Sono state inoltre realizzate delle staffe su misura per poter fissare gli apparecchi con il minor numero possibile di viti. Sotto le staffe sono presenti i corpi alimentazione (IP67) tutti dimmerabili singolarmente tramite DALI.



PONTE VECCHIO IN FLORENCE



The lighting system of Ponte Vecchio in Florence has been created manufacturing a special version of our outdoor spotlight QUANTUM P.

In order to integrate the fixtures into the environment in the most appropriate way, Quantum P has been manufactured with a customised finish (dark bronze), obtained by a very thick anodic coating.

The fixture has also been equipped with special brackets, developed to use only a little quantity of screws.









Under the brackets, there are IP67 boxes that contain DALI dimmable drivers. All drivers can be dimmed independently.



-  IP67
-  Class III 350mA - 24 Vdc
-  Class II 100-240 Vac
-  Montaggio a parete, soffitto, pavimento
Wall, ceiling, floor mounting
-  Cavo in neoprene 100 cm
100 cm neoprene cable
-  Collegare in serie 350mA
Connect in series at 350mA
-  Disponibile in versione 24Vdc
Available in 24Vdc version
-  Alimentazione integrata
Built-in driver
-  850 gr 350mA - 24 Vdc
-  1350 gr 100-240 Vac







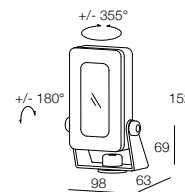



SIRIO 6 EVO

	6W 350mA	6W 24 Vdc	Finiture Finish	Colore LED LED Colour
Lumen 3000K	600lm	600lm		
 10° Lens	733143._ _	733144._ _	 3 Grigio - Gray  T Titanio - Titanium	 Y 2700K  6 3000K  9 4000K  1 5000K
 30° Lens	763143._ _	763144._ _		
 60° Lens	753143._ _	753144._ _		
	LED COLOUR		FINISH	



SIRIO 6 EVO

	6W 100-240 Vac	Finiture Finish	Colore LED LED Colour	
Lumen 3000K	600lm			
 10° Lens	733145._ _	 3 Grigio - Gray  T Titanio - Titanium	 Y 2700K  6 3000K  9 4000K  1 5000K	
 30° Lens	763145._ _			
 60° Lens	753145._ _			
	LED COLOUR		FINISH	

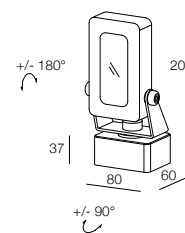

ALIMENTATORI CONSIGLIATI (non inclusi)
SUGGESTED DRIVERS (not included)

ACCESSORI
ACCESSORIES

350mA **CC20-F-350-N**
24 Vdc **CV20-F-24-N**







pag. 190
pag. 197



Picchetto in
acciaio Inox AISI 316L
Stainless Steel
316L stake
A00281.60











Connettore stagno
Watertight connector
A00387.40

-  IP67
-  Class III 350mA - 24 Vdc
-  Class II 100-240 Vac
-  Montaggio a parete, soffitto, pavimento
Wall, ceiling, floor mounting
-  Cavo in neoprene 100 cm
100 cm neoprene cable
-  Collegare in serie 350mA
Connect in series at 350mA
-  Disponibile in versione 24Vdc
Available in 24Vdc version
-  Alimentazione integrata
Built-in driver
-  1050 gr 350mA - 24 Vdc
-  1550 gr 100-240 Vac



SIRIO 9 EVO







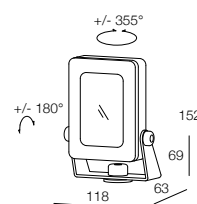

	9W 350mA	9W 24 Vdc	Finiture Finish	Colore LED LED Colour
Lumen 3000K	900lm	900lm		
 10° Lens	733140._ _	733141._ _	 3 Grigio - Gray	 Y 2700K
 30° Lens	763140._ _	763141._ _	 T Titanio - Titanium	 6 3000K
 60° Lens	753140._ _	753141._ _		 9 4000K
				 1 5000K

LED COLOUR

FINISH



SIRIO 9 EVO

	9W 100-240 Vac	Finiture Finish	Colore LED LED Colour
Lumen 3000K	900lm		
 10° Lens	733142._ _	 3 Grigio - Gray	 Y 2700K
 30° Lens	763142._ _	 T Titanio - Titanium	 6 3000K
 60° Lens	753142._ _		 9 4000K
			 1 5000K

LED COLOUR

FINISH

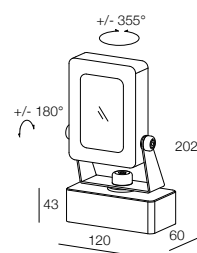

ALIMENTATORI CONSIGLIATI (non inclusi)
SUGGESTED DRIVERS (not included)

ACCESSORI
ACCESSORIES

350mA **CC20-F-350-N**
24 Vdc **CV20-F-24-N**

pag. 190
pag. 197











Piochetto in
acciaio Inox AISI 316L
Stainless Steel
316L stake
A00281.60



Connettore stagno
Watertight connector
A00387.40

-  IP67
-  Class III 350mA - 24 Vdc
-  Class II 100-240 Vac
-  Montaggio a parete, soffitto, pavimento
Wall, ceiling, floor mounting
-  Cavo in neoprene 100 cm
100 cm neoprene cable
-  Collegare in serie 350mA
Connect in series at 350mA
-  Disponibile in versione 24Vdc
Available in 24Vdc version
-  Alimentazione integrata
Built-in driver
-  1200 gr 350mA - 24 Vdc
-  1700 gr 100-240 Vac



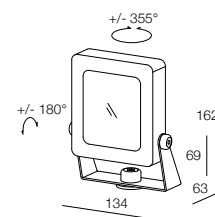

SIRIO 12 EVO

	12W 350mA	12W 24 Vdc	Finiture Finish	Colore LED LED Colour
Lumen 3000K	1200lm	1200lm		
 10° Lens	733137._ _	733138._ _	 3 Grigio - Gray	 Y 2700K
			 T Titanio - Titanium	 6 3000K
 30° Lens	763137._ _	763138._ _		 9 4000K
 60° Lens	753137._ _	753138._ _		 1 5000K



SIRIO 12 EVO

	12W 100-240 Vac	Finiture Finish	Colore LED LED Colour
Lumen 3000K	900lm		
 10° Lens	733139._ _	 3 Grigio - Gray	 Y 2700K
		 T Titanio - Titanium	 6 3000K
 30° Lens	763139._ _		 9 4000K
 60° Lens	753139._ _		 1 5000K

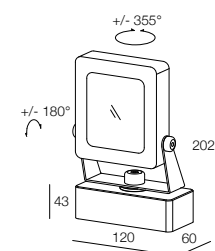

ALIMENTATORI CONSIGLIATI (non inclusi)
SUGGESTED DRIVERS (not included)



350mA **CC20-F-350-N** pag. 190
24 Vdc **CV20-F-24-N** pag. 197

ACCESSORI
ACCESSORIES

Picchetto in
acciaio Inox AISI 316L
Stainless Steel
316L stake
A00281.60











Watertight connector
A00387.40



-  IP67
-  Class III
-  Montaggio a parete, soffitto, pavimento
Wall, ceiling, floor mounting
-  Cavo in neoprene 100 cm
100 cm neoprene cable
-  Collegare in serie 350mA
Connect in series at 350mA
-  Disponibile in versione 24Vdc
Available in 24Vdc version
-  Alimentazione integrata
Built-in driver
-  1530 gr



SIRIO 20 EVO

	20W 350mA	20W 24 Vdc	Finiture Finish	Colore LED LED Colour
Lumen 3000K	2000lm	2000lm		
 10° Lens	733135._ _	733136._ _	 3 Grigio - Gray	 Y 2700K
 30° Lens	763135._ _	763136._ _	 T Titanio - Titanium	 6 3000K
 60° Lens	753135._ _	753136._ _		 9 4000K
				 1 5000K

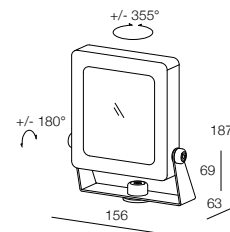

ALIMENTATORI CONSIGLIATI (non inclusi)
SUGGESTED DRIVERS (not included)

ACCESSORI
ACCESSORIES

350mA **CC50-F-350-N**
24 Vdc **CV20-F-24-N**

pag. 190
pag. 197



Picchetto in
acciaio Inox AISI 316L
Stainless Steel
316L stake
A00281.60



Connettore stagno
Watertight connector
A00387.40





PALETTI

BOLLARDS



600 ... 1900 lm







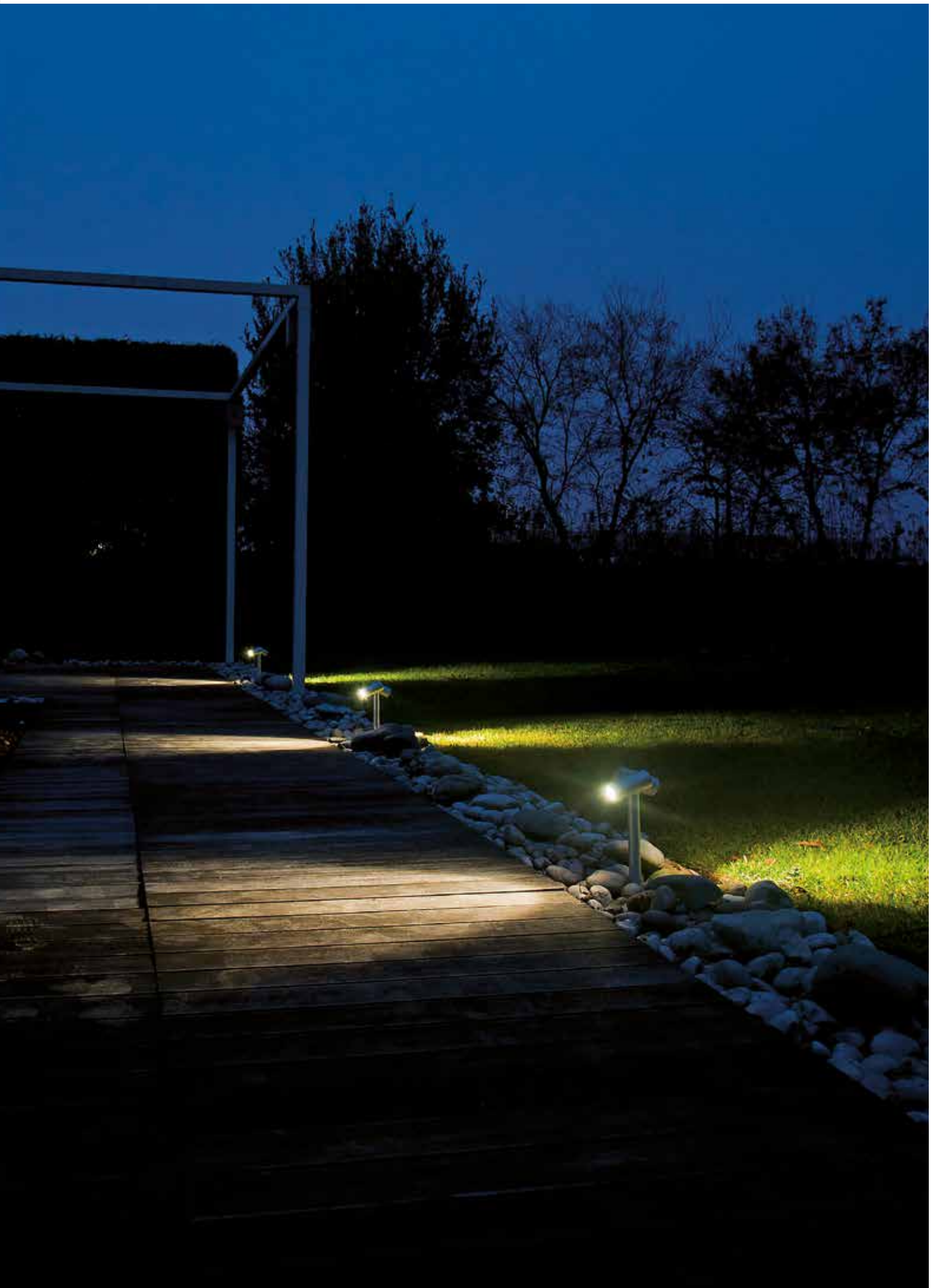

EDEN 6-8
page 158









EDEN 12-18
page 159





-  IP65
-  Class III
-  Montaggio a parete, soffitto, pavimento
Wall, ceiling, floor mounting H 117 - H 350
-  Montaggio a soffitto, pavimento
Ceiling, floor mounting H 900
-  Cavo in neoprene 100 cm
100 cm neoprene cable
-  Collegare in serie 180mA o 250mA
Connect in series at 180mA or 250mA

EDEN 6-8 H 117





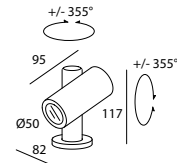

	6W 180mA	8W 250mA	Finiture Finish	Colore LED LED Colour
Lumen Output	600lm	800lm		
 15° Reflector	7A3455.3 _	7A3456.3 _	 3 Grigio - Gray	 Y 2700K  6 3000K  9 4000K  1 5000K
 40° Reflector	743455.3 _	743456.3 _		

LED COLOUR

FINISH



EDEN 6-8 H 350





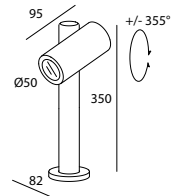

	6W 180mA	8W 250mA	Finiture Finish	Colore LED LED Colour
Lumen Output	600lm	800lm		
 15° Reflector	7A3457.3 _	7A3458.3 _	 3 Grigio - Gray	 Y 2700K  6 3000K  9 4000K  1 5000K
 40° Reflector	743457.3 _	743458.3 _		

LED COLOUR

FINISH



EDEN 6-8 H 900

	6W 180mA	8W 250mA	Finiture Finish	Colore LED LED Colour
Lumen Output	600lm	800lm		
 15° Reflector	7A3459.3 _	7A3460.3 _	 3 Grigio - Gray	 Y 2700K  6 3000K  9 4000K  1 5000K
 40° Reflector	743459.3 _	743460.3 _		

LED COLOUR

FINISH

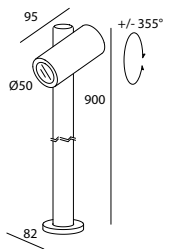

ALIMENTATORI CONSIGLIATI (non inclusi)
SUGGESTED DRIVERS (not included)

ACCESSORI
ACCESSORIES

180mA CC20-F-180-N
250mA CC20-F-250-N

pag. 188
pag. 188



Connettore stagno
Watertight connector
A00387.40

IP65

Class III

Montaggio a parete, soffitto, pavimento
Wall, ceiling, floor mounting H 150 - H 350

Montaggio a soffitto, pavimento
Ceiling, floor mounting H 700

Cavo in neoprene 100 cm
100 cm neoprene cable

Collegare in serie 350mA o 500mA
Connect in series at 350mA or 500mA



EDEN 12-18 H 150

	12W 350mA	18W 500mA	Finiture Finish	Colore LED LED Colour
Lumen Output	1400lm	1900lm		
10° Reflector	733461.3 _	733462.3 _	3 Grigio - Gray	Y 2700K 6 3000K 9 4000K 1 5000K
20° Reflector	783461.3 _	783462.3 _		
40° Reflector	743461.3 _	743462.3 _		

LED COLOUR
FINISH

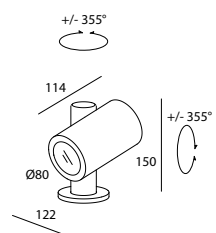

EDEN 12-18 H 350

	12W 350mA	18W 500mA	Finiture Finish	Colore LED LED Colour
Lumen Output	1400lm	1900lm		
10° Reflector	733463.3 _	733464.3 _	3 Grigio - Gray	Y 2700K 6 3000K 9 4000K 1 5000K
20° Reflector	783463.3 _	783464.3 _		
40° Reflector	743463.3 _	743464.3 _		

LED COLOUR
FINISH

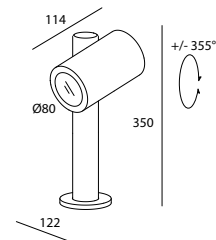

EDEN 12-18 H 700

	12W 350mA	18W 500mA	Finiture Finish	Colore LED LED Colour
Lumen Output	1400lm	1900lm		
10° Reflector	733465.3 _	733466.3 _	3 Grigio - Gray	Y 2700K 6 3000K 9 4000K 1 5000K
20° Reflector	783465.3 _	783466.3 _		
40° Reflector	743465.3 _	743466.3 _		

LED COLOUR
FINISH

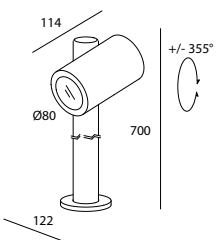

ALIMENTATORI CONSIGLIATI (non inclusi)
SUGGESTED DRIVERS (not included)

ACCESSORI
ACCESSORIES

350mA CC20-F-350-N
500mA CC20-F-500-N

pag. 190
pag. 192



Connettore stagno
Watertight connector
A00387.40

DGA

ESTERNO
OUTDOOR

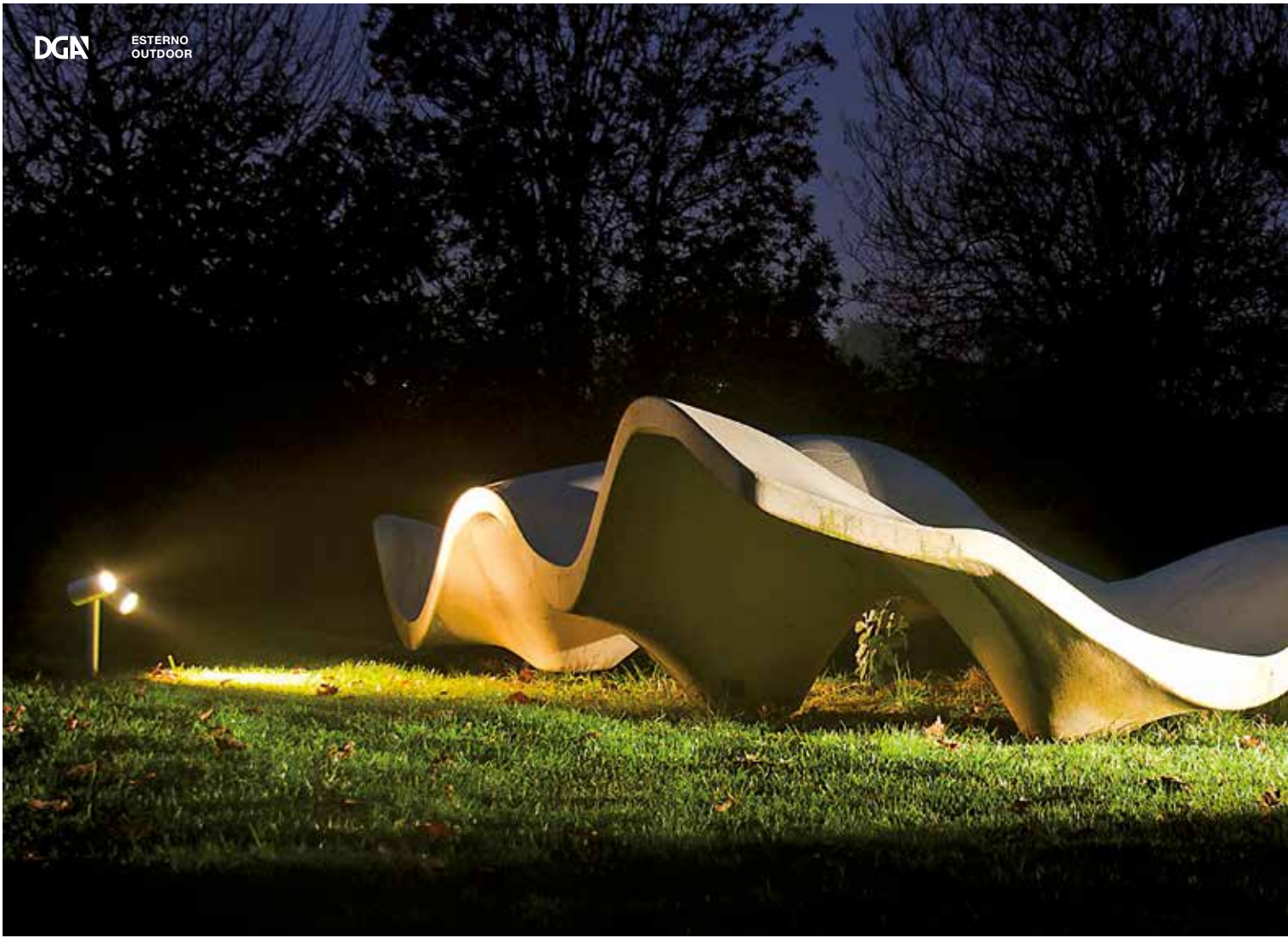

EDEN SERIES



PROIETTORI SCENOGRAFICI RGBW - DMX

FLOODLIGHTS RGBW - DMX



IRIDE 3 i
page 164



IRIDE 3 P
page 165



IRIDE 9
page 167



IRIDE 15
page 169



LO SPETTACOLO
DELLA LUCE IN SCENA
LET'S START WITH
THE LIGHT SHOW

I proiettori scenografici IRIDE sono progettati da DGA con una tecnologia di gestione del colore innovativa e di ultima generazione. I LED utilizzati operano con tecnologia RGBW (Red, Green, Blue, White), montati su ogni singola ottica. Questa tecnologia permette una miscelazione ottimale dei colori, che risulteranno estremamente saturi e brillanti. Tutti i proiettori della linea IRIDE sono programmabili da centralina DMX e sono particolarmente indicati per illuminazioni architettoniche e scenografiche.

IRIDE floodlights are designed by DGA with an innovative and last generation colours control system. The LEDs operate with RGBW technology (Red, Green, Blue, White). They are mounted on a single optic. This technology permits an excellent mixing of the various colours, which will appear extremely saturated and bright. All the floodlights of the IRIDE line can be set by a DMX controller, and they are particularly indicated for architectural and sceneries lighting.



-  IP67
-  Class III
-  Incasso a pavimento
Floor recessed
-  Carrabile 2000 kg
Drive over up to 2000 kg
-  Installazione con controcassa obbligatoria
Recessed box needed
-  Fornito con cavi uscenti in neoprene L=100cm
Provided with outgoing neoprene cables L=100cm
24V - DMX in - DMX out
-  Collegare in parallelo 24Vdc
Connect in parallel at 24Vdc
-  1020 gr

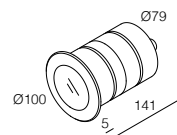

IRIDE 3 i



ALL WHITE
Controller DMX
20W
24 Vdc











DYNAMIC WHITE
Controller DMX
20W
24 Vdc

RGBW - DMX
Controller DMX
20W
24 Vdc

Finiture
Finish

Colore LED
LED Colour

	ALL WHITE Controller DMX 20W 24 Vdc	DYNAMIC WHITE Controller DMX 20W 24 Vdc	RGBW - DMX Controller DMX 20W 24 Vdc	Finiture Finish	Colore LED LED Colour
 30° Lens	760628._ _	760628._ 8	763381._ 7	 3 Grigio - Gray  4 Nero - Black  T Titanio - Titanium	 Y 2700K  6 3000K  9 4000K  1 5000K
 60° Lens	750628._ _	750628._ 8	753381._ 7		

LED COLOUR FINISH	DYNAMIC WHITE FINISH	RGBW - DMX FINISH
----------------------	-------------------------	----------------------

ALIMENTATORI CONSIGLIATI (non inclusi)
SUGGESTED DRIVERS (not included)

24 Vdc **CV70-F-24-N**
Controller DMX

pag. 197

pag. 204

ACCESSORI
ACCESSORIES









Controcassa
Recessed box
A00204.30



Controcassa
Recessed box
A00276.40



 Ø 92 mm

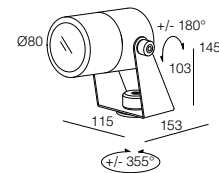

-  IP67
-  Class III
-  Montaggio a parete, soffitto, pavimento
Wall, ceiling, floor mounting
-  Fornito con cavi uscenti in neoprene L=100cm
Provided with outgoing neoprene cables L=100cm
24V - DMX in - DMX out
-  Collegare in parallelo 24Vdc
Connect in parallel at 24Vdc
-  1140 gr



IRIDE 3 P

	<input type="checkbox"/> ALL WHITE Controller DMX 20W 24 Vdc	<input type="checkbox"/> DYNAMIC WHITE Controller DMX 20W 24 Vdc	<input type="checkbox"/> RGBW - DMX Controller DMX 20W 24 Vdc	Finiture Finish	Colore LED LED Colour
 30° Lens	760591._ _	760591._ 8	763383._ 7	<input type="checkbox"/> 3 Grigio - Gray <input type="checkbox"/> 4 Nero - Black <input type="checkbox"/> T Titanio - Titanium	<input type="checkbox"/> Y 2700K <input type="checkbox"/> 6 3000K <input type="checkbox"/> 9 4000K <input type="checkbox"/> 1 5000K
 60° Lens	750591._ _	750591._ 8	753383._ 7		
	LED COLOUR FINISH	DYNAMIC WHITE FINISH	RGBW - DMX FINISH		

ALIMENTATORI CONSIGLIATI (non inclusi)
SUGGESTED DRIVERS (not included)

24 Vdc **CV70-F-24-N** pag. 197
Controller DMX pag. 204





IP65

Class III

Montaggio a parete, soffitto, pavimento
Wall, ceiling, floor mounting

Fornito con cavi uscenti in neoprene L=100cm
Provided with outgoing neoprene cables L=100cm
24V - DMX in - DMX out

Collegare in parallelo 24Vdc
Connect in parallel at 24Vdc

3700 gr

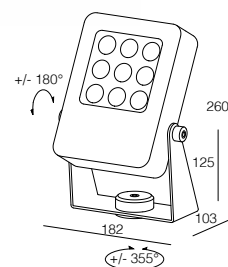

IRIDE 9



ALL WHITE
Controller DMX
60W
24 Vdc



DYNAMIC WHITE
Controller DMX
60W
24 Vdc

RGBW - DMX
Controller DMX
60W
24 Vdc

Finiture
Finish

Colore LED
LED Colour



30° Lens

760589._ _

760589._ 8

763385._ 7



3 Grigio - Gray



4 Nero - Black



T Titanio - Titanium



Y 2700K



6 3000K



9 4000K



1 5000K



60° Lens

750589._ _

750589._ 8

753385._ 7

LED COLOUR
FINISH

DYNAMIC WHITE
FINISH

RGBW - DMX
FINISH

ALIMENTATORI CONSIGLIATI (non inclusi)
SUGGESTED DRIVERS (not included)







24 Vdc **CV150-F-24-N**
Controller DMX

pag. 197

pag. 204





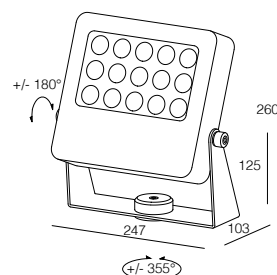

-  IP65
-  Class III
-  Montaggio a parete, soffitto, pavimento
Wall, ceiling, floor mounting
-  Fornito con cavi uscenti in neoprene L=100cm
Provided with outgoing neoprene cables L=100cm
24V – DMX in – DMX out
-  Collegare in parallelo 24Vdc
Connect in parallel at 24Vdc
-  5500 gr



IRIDE 15

<input type="checkbox"/>	ALL WHITE Controller DMX 100W 24 Vdc	<input type="checkbox"/>	DYNAMIC WHITE Controller DMX 100W 24 Vdc	<input type="checkbox"/>	RGBW - DMX Controller DMX 100W 24 Vdc
--------------------------	--	--------------------------	--	--------------------------	---

Finiture Finish Colore LED LED Colour

 30° Lens	760590._ _	760590._ 8	763386._ 7	<input type="checkbox"/> 3 Grigio - Gray	<input type="checkbox"/> Y 2700K
				<input type="checkbox"/> 4 Nero - Black	<input type="checkbox"/> 6 3000K
				<input type="checkbox"/> T Titanio - Titanium	<input type="checkbox"/> 9 4000K
 60° Lens	750590._ _	750590._ 8	753386._ 7	<input type="checkbox"/> 1 5000K	

LED COLOUR FINISH	DYNAMIC WHITE FINISH	RGBW - DMX FINISH
----------------------	-------------------------	----------------------

ALIMENTATORI CONSIGLIATI (non inclusi)
SUGGESTED DRIVERS (not included)

24 Vdc **CV150-F-24-N** pag. 197
Controller DMX pag. 204







APPLIQUE A PARETE

WALL MOUNTING APPLIQUES

100 ... 400 lm



ZENITH
page 174



ZENITH DUO
page 175



QUARK EVO
page 176



ORION EVO
page 180





BIEMISSIONE
DOUBLE LIGHT EMISSION



IP65



Class III



Montaggio a parete
Wall mounting



Cavo in neoprene 100 cm
100 cm neoprene cable



Collegare in serie 350mA o 500mA
Connect in series at 350mA or 500mA



Disponibile in versione 24Vdc
Available in 24Vdc version



330 gr

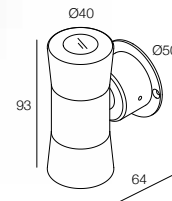

ZENITH DUO

	1W x2 350mA	1W x2 24 Vdc	2W x2 500mA	2W x2 24 Vdc	Finiture Finish	Colore LED LED Colour
Lumen 3000K	100lm x 2	100lm x 2	150lm x 2	150lm x 2		
10° Lens	733573._ _	733574._ _	733575._ _	733576._ _	3 Grigio - Gray 4 Nero - Black	Y 2700K 6 3000K 9 4000K 1 5000K
30° Lens	763573._ _	763574._ _	763575._ _	763576._ _		
60° Lens	753573._ _	753574._ _	753575._ _	753576._ _		

LED COLOUR

FINISH

ALIMENTATORI CONSIGLIATI (non inclusi)
SUGGESTED DRIVERS (not included)

350mA **CC20-F-350-N** pag. 190
500mA **CC20-F-500-N** pag. 192
24 Vdc **CV70-F-24-N** pag. 197

ACCESSORI
ACCESSORIES



Micro connettore
stagno
Micro watertight
connector
A00357.40



Disponibile in due versioni:
monoemissione e biemissione

Available in two versions:
single and double light emission





Versione
ottone integrale

Completely
made of brass

10° 30° 40°

Tre diverse aperture dei fasci luminosi
Three different optics

QUARK EVO

-  IP67
-  Class III 350mA - 500mA - 24 Vdc
-  Class II 100-240 Vac
-  Montaggio a parete
Wall mounting
-  Cavo in neoprene 100 cm
100 cm neoprene cable
-  Collegare in serie 350mA o 500mA
Connect in series at 350mA or 500mA
-  Disponibile in versione 24Vdc
Available in 24Vdc version
-  Alimentazione integrata, collegare alla tensione di rete 100/240Vac
Built-in driver, connect to the main voltage 100/240Vac
-  500 gr monoemissione - single light emission
-  600 gr biemissione - double light emission

ALIMENTATORI CONSIGLIATI (non inclusi)
SUGGESTED DRIVERS (not included)

350mA	CC20-F-350-N	pag. 190
500mA	CC20-F-500-N	pag. 192
24 Vdc	CV70-F-24-N	pag. 197

QUARK EVO



	1W 350mA	2W 500mA	Finiture Finish	Colore LED LED Colour
Lumen 3000K	100lm	150lm		
10° Lens	733180._ _	733181._ _	3 Grigio - Gray 4 Nero - Black T Titanio - Titanium E Ottone integrale Completely made of brass	Y 2700K 6 3000K 9 4000K 1 5000K
30° Lens	763180._ _	763181._ _		
40° Lens	743180._ _	743181._ _		

LED COLOUR
FINISH

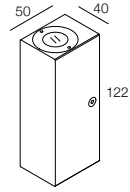

QUARK EVO

	1W 24 Vdc	2W 24 Vdc	Finiture Finish	Colore LED LED Colour
Lumen 3000K	100lm	150lm		
10° Lens	733182._ _	733183._ _	3 Grigio - Gray 4 Nero - Black T Titanio - Titanium E Ottone integrale Completely made of brass	Y 2700K 6 3000K 9 4000K 1 5000K
30° Lens	763182._ _	763183._ _		
40° Lens	743182._ _	743183._ _		

LED COLOUR
FINISH

QUARK EVO

	1W 100-240 Vac	2W 100-240 Vac	Finiture Finish	Colore LED LED Colour
Lumen 3000K	100lm	150lm		
10° Lens	733184._ _	733185._ _	3 Grigio - Gray 4 Nero - Black T Titanio - Titanium E Ottone integrale Completely made of brass	Y 2700K 6 3000K 9 4000K 1 5000K
30° Lens	763184._ _	763185._ _		
40° Lens	743184._ _	743185._ _		

LED COLOUR
FINISH

QUARK EVO



	1W x 2 350mA	2W x 2 500mA	Finiture Finish	Colore LED LED Colour
Lumen 3000K	100lm x 2	150lm x 2		
10° Lens	733186._ _	733187._ _	3 Grigio - Gray 4 Nero - Black T Titanio - Titanium E Ottone integrale Completely made of brass	Y 2700K 6 3000K 9 4000K 1 5000K
30° Lens	763186._ _	763187._ _		
40° Lens	743186._ _	743187._ _		

LED COLOUR
FINISH

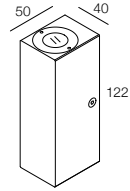

QUARK EVO

	1W x 2 24 Vdc	2W x 2 24 Vdc	Finiture Finish	Colore LED LED Colour
Lumen 3000K	100lm x 2	150lm x 2		
10° Lens	733188._ _	733189._ _	3 Grigio - Gray 4 Nero - Black T Titanio - Titanium E Ottone integrale Completely made of brass	Y 2700K 6 3000K 9 4000K 1 5000K
30° Lens	763188._ _	763189._ _		
40° Lens	743188._ _	743189._ _		

LED COLOUR
FINISH

QUARK EVO

	1W x 2 100-240 Vac	2W x 2 100-240 Vac	Finiture Finish	Colore LED LED Colour
Lumen 3000K	100lm x 2	150lm x 2		
10° Lens	733190._ _	733191._ _	3 Grigio - Gray 4 Nero - Black T Titanio - Titanium E Ottone integrale Completely made of brass	Y 2700K 6 3000K 9 4000K 1 5000K
30° Lens	763190._ _	763191._ _		
40° Lens	743190._ _	743191._ _		

LED COLOUR
FINISH





Alimentazione integrata

Built-in driver







Sistema di
dissipazione brevettato

Patented heat
dissipation system



Vetro temperato ad alta resistenza
Hi-resistance tempered glass

ORION EVO



-  IP67
-  Class III 350mA - 24 Vdc
-  Class II 100-240 Vac
-  Montaggio a parete
Wall mounting
-  Cavo in neoprene 100 cm
100 cm neoprene cable
-  Collegare in serie 350mA
Connect in series at 350mA
-  Disponibile in versione 24Vdc
Available in 24Vdc version
-  Alimentazione integrata, collegare alla tensione di rete 100/240Vac
Built-in driver, connect to the main voltage 100/240Vac
-  1000 gr monoemissione - single light emission
-  1200 gr biemissione - double light emission



Ottone integrale
Completely made of brass

 **MONOEMISSIONE**
SINGLE LIGHT EMISSION



ORION EVO

Lumen 3000K	4W 350mA 400lm	4W 24 Vdc 400lm	Finiture Finish	Colore LED LED Colour
 15° Lens	7A3598._ _	7A3599._ _	3 Grigio - Gray 4 Nero - Black T Titanio - Titanium E Ottone integrale Completely made of brass	Y 2700K 6 3000K 9 4000K 1 5000K
 30° Lens	763598._ _	763599._ _		
 60° Lens	753598._ _	753599._ _		

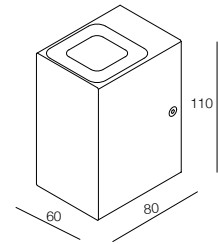
LED COLOUR
FINISH





ORION EVO

Lumen 3000K	4W 100-240 Vac 400lm	Finiture Finish	Colore LED LED Colour
 15° Lens	7A3600._ _	3 Grigio - Gray 4 Nero - Black T Titanio - Titanium E Ottone integrale Completely made of brass	Y 2700K 6 3000K 9 4000K 1 5000K
 30° Lens	763600._ _		
 60° Lens	753600._ _		

LED COLOUR
FINISH

ORION EVO



Lumen 3000K	4W x2 350mA 400lm x 2	4W x2 24 Vdc 400lm x 2	Finiture Finish	Colore LED LED Colour
 15° Lens	7A3601._ _	7A3602._ _	3 Grigio - Gray 4 Nero - Black T Titanio - Titanium E Ottone integrale Completely made of brass	Y 2700K 6 3000K 9 4000K 1 5000K
 30° Lens	763601._ _	763602._ _		
 60° Lens	753601._ _	753602._ _		

LED COLOUR
FINISH

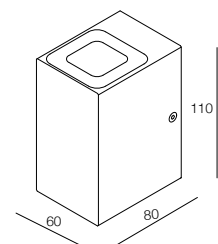
 **BIEMISSIONE**
DOUBLE LIGHT EMISSION



ORION EVO

Lumen 3000K	4W x2 100-240 Vac 400lm x 2	Finiture Finish	Colore LED LED Colour
 15° Lens	7A3603._ _	3 Grigio - Gray 4 Nero - Black T Titanio - Titanium E Ottone integrale Completely made of brass	Y 2700K 6 3000K 9 4000K 1 5000K
 30° Lens	763603._ _		
 60° Lens	753603._ _		

LED COLOUR
FINISH

ALIMENTATORI CONSIGLIATI (non inclusi)
SUGGESTED DRIVERS (not included)

350mA **CC20-F-350-N** pag. 190
500mA **CC20-F-500-N** pag. 192
24 Vdc **CV20-F-24-N** pag. 197

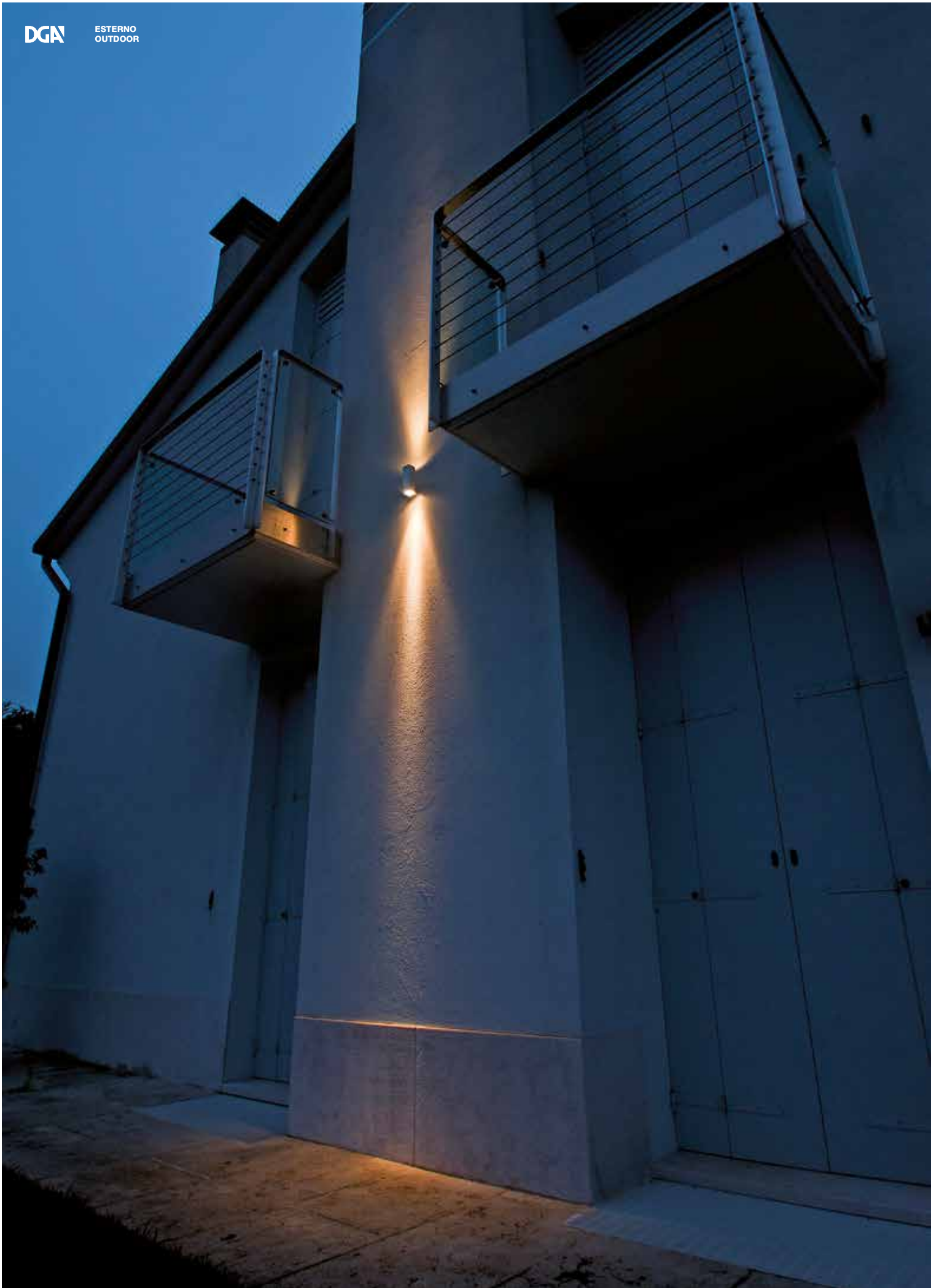





COMETA LC IP65

Alto indice di resa cromatica
High colour rendering index

Apparecchio ad elevata efficienza

Fixture with Hi-efficacy LED module







Minimo spessore
Minimum thickness

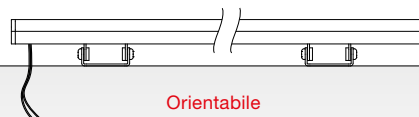

Fissa
Fixed







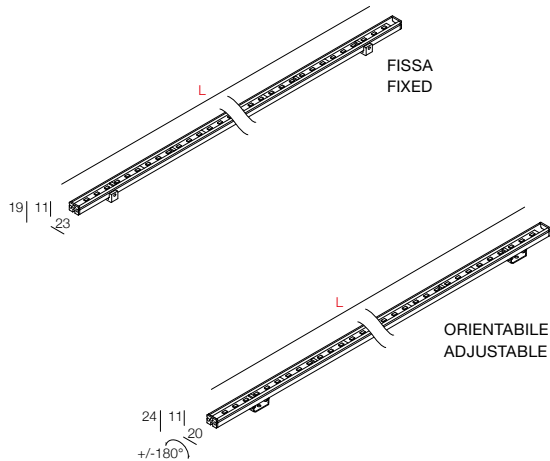



Orientabile
Adjustable



-  IP65
-  Class III
-  Montaggio a parete, soffitto, pavimento
Wall, ceiling, floor mounting
-  Collegare in parallelo 24Vdc
Connect in parallel at 24Vdc

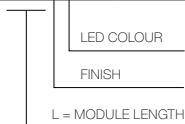

COMETA LC IP65

IP65	25W/m 24 Vdc	Finiture Finish	Colore LED LED Colour
Lumen 3000K	2000lm/m		
Fissa Fixed	 Copertura satinata Frosted cover	LF12-___.3_	 3 Grigio - Gray
Orientabile Adjustable	 Copertura satinata Frosted cover	LO12-___.3_	 Y 2700K  6 3000K  W 3000K CRI > 90  9 4000K  1 5000K



-  50 cm Lunghezze modulo minimo 50 cm
-  200 cm massimo 200 cm, con multipli di 10 cm.

Module lengths are available from 50 cm up to 200 cm by multiple of 10 cm.

ALIMENTATORI CONSIGLIATI (non inclusi)
SUGGESTED DRIVERS (not included)

ACCESSORI
ACCESSORIES

24 Vdc **CV70-F-24-N**

pag. 197

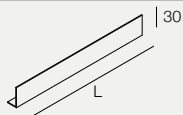

Su richiesta, disponibile con visiera
Visor available upon request





DGN

DRIVER & ACCESSORIES

ALIMENTATORI DRIVERS

Per il corretto funzionamento di un apparecchio LED DGA è necessario abbinare il giusto alimentatore.

Nella tabella dei dati tecnici, presente in ogni pagina prodotto, è possibile leggere la potenza espressa in Watt (es: 1W, 2W, 6W...) e la relativa corrente di alimentazione (es: 350mA, 500mA, etc.). Alcune tipologie di prodotti sono disponibili con alimentazione remota 24Vdc, o con alimentazione integrata (collegamento diretto alla tensione di rete).

È possibile scegliere l'alimentatore più indicato a seconda delle sue caratteristiche tecniche:

- N° LED MAX collegabili
- Dimmerabile
- Dimmerabile DALI
- Marchiato UL
- Protezione IP65 o IP67

Tutti gli alimentatori a corrente costante (350mA, 500mA, 700mA...) sono raggruppati in pagine dedicate e suddivisi in base alla corrente. Su questa tipologia di alimentatori prevedere sempre un collegamento elettrico in serie.

For the correct functioning of a DGA light fixture it is fundamental to select the appropriate driver.

In the table reporting the technical data, visible in every product page, it is possible to identify the power in Watt (e.g. 1W, 2W, 6W, etc.) and the relevant current to be used to run that product (e.g. 350mA, 500mA, etc.). Some product families are available with remote power supply at 24Vdc, or with built-in driver (for a direct connection to the main voltage).

It is possible to choose the most appropriate driver according to its technical features:

- Max. number of LEDs to connect
- Dimmable
- DALI Dimmable
- UL Listed
- With IP65 or IP67 protection rate

All our constant current drivers (350mA, 500mA, etc.) are grouped in dedicated pages, split according to the current. With this family of drivers, we remind you to arrange always a series connection.

ALIMENTATORI DIMMERABILI MULTIFUNZIONE MULTIFUNCTION DIMMABLE DRIVERS

FUNZIONAMENTO DELL'ALIMENTATORE DIMMERABILE MULTIFUNZIONE

L'alimentatore è un dimmer in grado di variare la luminosità dei LED collegati attraverso un segnale di controllo tipo 1÷10V, potenziometro o pulsante normalmente aperto. I collegamenti devono essere eseguiti come mostrato negli schemi dei manuali d'uso e manutenzione.

Funzionamento con 1÷10 V e 0-10 V

La luminosità dei led varia proporzionalmente al segnale inviato al morsetto. La luminosità è nulla con segnale minore di 1V.

Funzionamento con potenziometro

Ruotando il potenziometro si ha la variazione della luminosità dei LED in modo proporzionale o logaritmico a seconda del modello di potenziometro utilizzato.

Si consiglia l'utilizzo di un potenziometro logaritmico.

Funzionamento con pulsante

Premendo il pulsante per un tempo inferiore a un secondo si ha l'accensione o lo spegnimento dei LED.

Premendo il pulsante per un tempo superiore a un secondo si ha la regolazione della luminosità dei LED secondo le seguenti modalità:

- Se la luminosità non è al massimo, premendo il tasto si avrà un incremento di questa fino al massimo o fino al livello corrispondente al momento in cui si rilascia il tasto.
- Un'ulteriore pressione del tasto inverte il verso di regolazione fino al valore minimo o fino al livello corrispondente al momento in cui si rilascia il tasto.
- Se la luminosità è al massimo premendo il tasto si avrà un decremento di questa fino al valore minimo o fino al livello corrispondente al momento in cui si rilascia il tasto.

OPERATION INSTRUCTIONS OF THE MULTIFUNCTION DIMMABLE DRIVER

The driver is a dimmer which can vary the light intensity of the connected LEDs by means of a type 1÷10V control signal, potentiometer or normally open push button. The connections must be carried out as shown in the diagrams of the instruction sheets.

1÷10 V and 0-10 V function

The light intensity of the LEDs vary proportionally to the signal sent to the terminal. Intensity is null with a signal less than 1V.

Potentiometer function

By rotating the potentiometer there is variation of the LED light intensity in a proportionate or logarithmic way depending on the model of the potentiometer used. The use of a logarithmic potentiometer is recommended.

Push button function

By pressing the push button for less than one second the LEDs turn on or off. By pressing the push button for more than one second the light intensity of the LEDs is dimmed according to the following modalities:

- If the light intensity is not at maximum, by pressing the key there will be an increase of this to maximum or to the corresponding level at the moment the key is released.
- A further pressure on the key inverts the dimming direction to the minimum value or to the corresponding level at the moment the key is released.
- If light intensity is at maximum by pressing the key there will be a decrease to the minimum value or to the corresponding level at the moment the key is released.



ATTENZIONE:

Per un buon funzionamento degli alimentatori, è necessario prevedere un adeguato scambio termico in fase di installazione.

NON è possibile installare gli alimentatori in scatole di derivazione stagne in materiale plastico. Se strettamente necessario, meglio prevedere scatole di derivazione in materiale metallico.

Si consiglia di installare gli alimentatori in luoghi asciutti e ben areati.



CAUTION:

For a good functioning of DGA drivers, it is necessary to foresee a good thermal exchange during the installation.

It is NOT possible to install drivers in plastic junction boxes. If necessary, please use metallic junction boxes.

We suggest to install drivers in dry and well ventilated environments.

DISTANZA TRA ALIMENTATORE E APPARECCHI LED

La distanza massima (consentita) tra un alimentatore DGA ed una serie di apparecchi LED varia a seconda della sezione del cavo utilizzato. Rispettare in ogni caso lo schema e attenersi alle indicazioni riportate in tabella.

Distance between driver and LED fixtures

The maximum distance between a driver and a group of LED fixtures varies according to the cable section to use. In any case, please check the diagram and stick to the instructions written in the table.

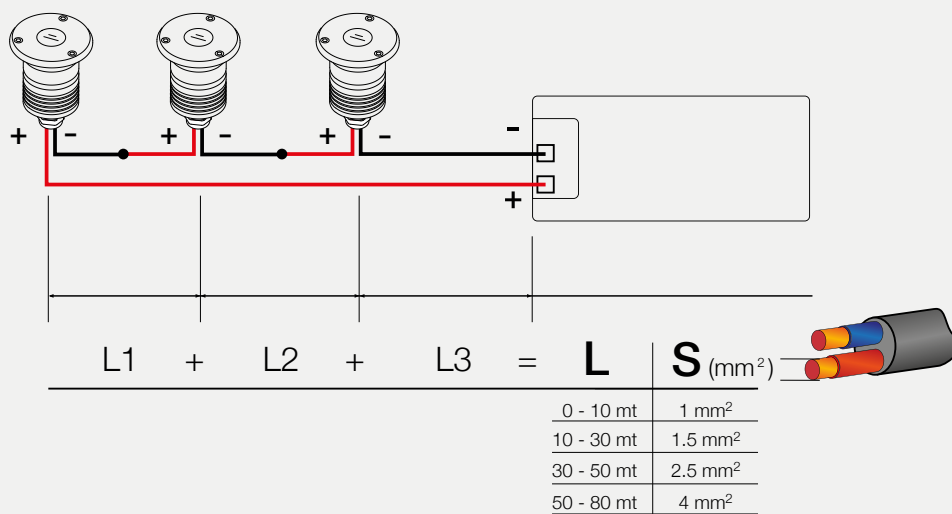

CODIFICA ALIMENTATORI DRIVERS ENCODING

DGA, nella continua ricerca di miglioramenti tecnici, ha inserito un nuovo tipo di codifica per tutti i suoi alimentatori. Di seguito la scomposizione di un codice (esempio) di un alimentatore:

DGA, in its continuous research of technical enhancements, has developed new types of codes for all its drivers.

Here below you will find an example of the breaking down of a new code:

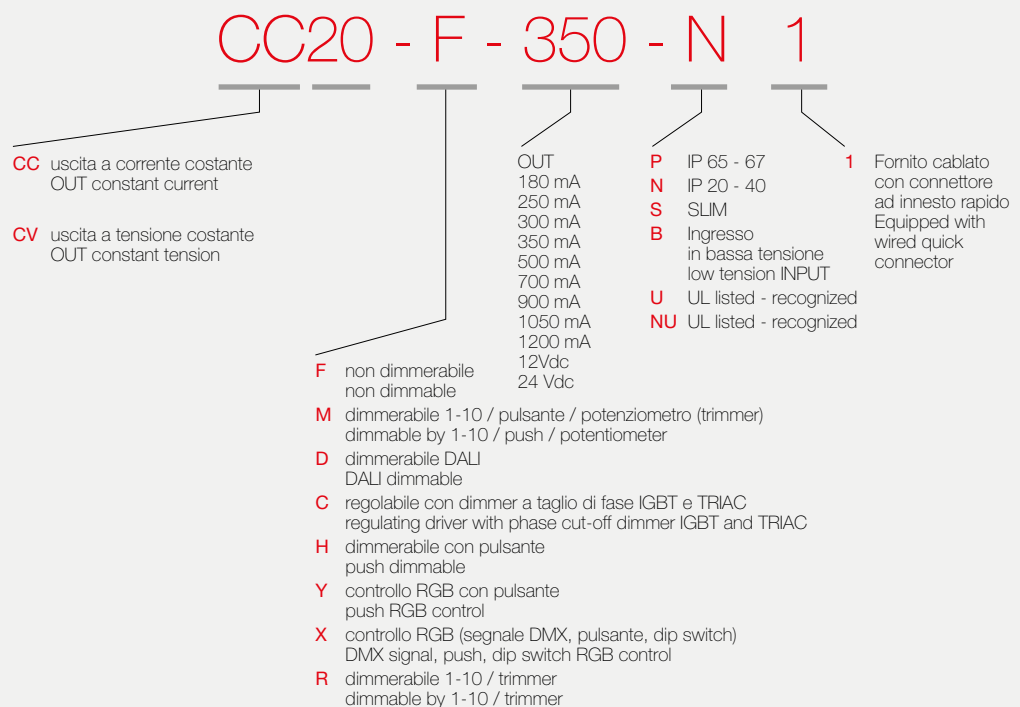



ALIMENTATORI 180mA LED DRIVERS

USE WITH: 6W

NON DIMMERABILI NON-DIMMABLE

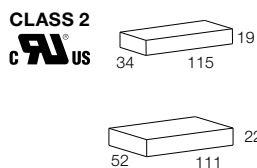
 IP20



Code	nr. LED collegabili nr. of LEDs to connect	Vin	
CC14-F-180-N	min. 1 - max 1 LED 6W	100-240 Vac	Ø 40
CC20-F-180-N	min. 1 - max 1 LED 6W	220-240 Vac	Ø 55

DRIVERS IP67

 IP67

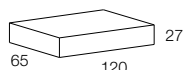

With box
A00294.30
page 207

Code	nr. LED collegabili nr. of LEDs to connect	Vin	
CC20-F-180-P	min. 1 - max 1 LED 6W	220-240 Vac	Ø 75

DIMMERABILI DIMMABLE

 IP20

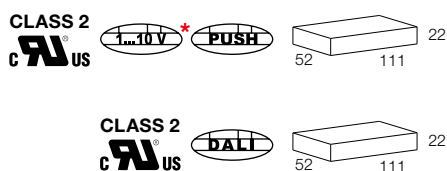

Code	nr. LED collegabili nr. of LEDs to connect	Vin	
CC20-M-180-N MULTIFUNZIONE	min. 1 - max 1 LED 6W	110-240 Vac	Ø 55
CC20-D-180-N DALI	min. 1 - max 1 LED 6W	110-240 Vac	Ø 55

ALIMENTATORI 250mA LED DRIVERS

USE WITH: 8W

NON DIMMERABILI NON-DIMMABLE

 IP20

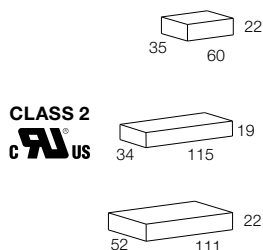

Code	nr. LED collegabili nr. of LEDs to connect	Vin	
CC9-F-250-N	min. 1 - max 1 LED 8W	220-240 Vac	Ø 42
CC14-F-250-N	min. 1 - max 1 LED 8W	100-240 Vac	Ø 40
CC20-F-250-N	min. 1 - max 1 LED 8W	220-240 Vac	Ø 55

DRIVERS IP67

 IP67

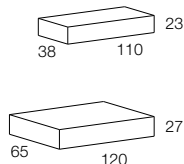



With box
A00294.30
page 207

Code	nr. LED collegabili nr. of LEDs to connect	Vin	
CC15-F-250-P	min. 1 - max 1 LED 8W	220-240 Vac	Ø 45
CC20-F-250-P	min. 1 - max 1 LED 8W	220-240 Vac	Ø 75

DIMMERABILI DIMMABLE

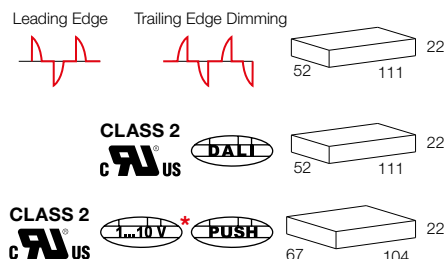
 IP20



Code	nr. LED collegabili nr. of LEDs to connect	Vin	
CC12-C-250-N	min. 1 - max 1 LED 8W	220-240 Vac	Ø 55
CC20-D-250-N DALI	min. 1 - max 1 LED 8W	110-240 Vac	Ø 55
CC32-M-250-N MULTIFUNZIONE	min. 1 - max 1 LED 8W	110-240 Vac	Ø 70

* POTENZIOMETRO
POTENTIOMETER

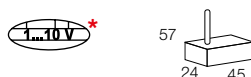

97000288

ALIMENTATORI 300mA LED DRIVERS

USE WITH: 10W

NON DIMMERABILI NON-DIMMABLE

 IP20

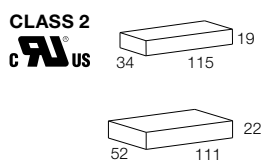

Code	nr. LED collegabili nr. of LEDs to connect	Vin	
CC14-F-300-N	min. 1 - max 1 LED 10W	100-240 Vac	Ø 40
CC20-F-300-N	min. 1 - max 1 LED 10W	220-240 Vac	Ø 55

DRIVERS IP67

 IP67

With box
A00294.30
page 207

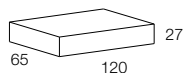

Code	nr. LED collegabili nr. of LEDs to connect	Vin	
CC20-F-300-P	min. 1 - max 1 LED 10W	220-240 Vac	Ø 75

DIMMERABILI DIMMABLE

 IP20



Code	nr. LED collegabili nr. of LEDs to connect	Vin	
CC32-D-300-N DALI	min. 1 - max 1 LED 10W	110-240 Vac	Ø 55



CC32-M-300-N MULTIFUNZIONE	min. 1 - max 1 LED 10W	110-240 Vac	Ø 70
-------------------------------	------------------------	-------------	------



CC40-M-300-N	min. 1 - max 1 LED 10W	120-277 Vac	Ø 38
--------------	------------------------	-------------	------

* **POTENZIOMETRO**
POTENTIOMETER

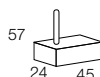

97000288

ALIMENTATORI 350mA LED DRIVERS

USE WITH: 1W - 3W (3x1W) - 7W (7x1W) - 4W - 12W

NON DIMMERABILI
NON-DIMMABLE
 IP20

CLASS 2

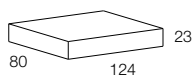
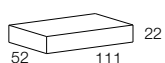
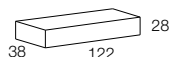
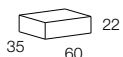
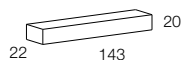

Code	nr. LED collegabili		Vin	
	nr. of LEDs to connect			
CC15-F-350-S	min. 1 - max 12 LED 1W		220-240 Vac	Ø 29
	min. 1 - max 3 LED 4W		100-127 Vac	
CC6-F-350-N	min. 1 - max 5 LED 1W		100-240 Vac	Ø 40
CC17-F-350-N	min. 1 - max 1 LED 12W		220-240 Vac	Ø 50
	min. 1 - max 4 LED 4W			
CC20-F-350-N	min. 1 - max 12 LED 1W		220-240 Vac	Ø 55
	min. 1 - max 3 LED 4W			
CC50-F-350-N	min. 1 - max 23 LED 1W		110-240 Vac	Ø 82
	min. 1 - max 6 LED ZOOM			

DRIVERS IP67

 IP67
With box
A00294.30
page 207
CLASS 2

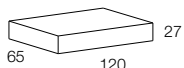
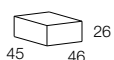

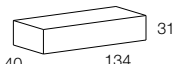
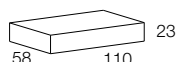
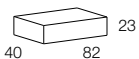
CLASS 2



Trailing Edge Dimming

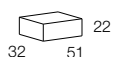

Code	nr. LED collegabili		Vin	
	nr. of LEDs to connect			
CC6-F-350-P	min. 1 - max 5 LED 1W		120-240 Vac	Ø 52
CC10-M-350-P	min. 1 - max 1 LOLED 3W		110-240 Vac	Ø 75
CC12-F-350-P	min. 1 - max 10 LED 1W		120-240 Vac	Ø 42
CC15-F-350-P	min. 1 - max 2 LED 4W			Ø 45
	min. 1 - max 1 LED 12W		220-240 Vac	
CC18-C-350-P	min. 1 - max 14 LED 4W			Ø 55
	min. 9 - max 16 LED 1W		220-240 Vac	
	min. 1 - max 1 LED 12W			
	min. 3 - max 5 LED 4W			
	min. 2 - max 4 LED ZOOM			
	min. 1 - max 1 LED ZOOM			

PER IMBARCAZIONI
FOR BOATS
 IP20

Code	nr. LED collegabili		Vin	
	nr. of LEDs to connect			
CC10-F-350-NB	min. 1 - max 3 LED 1W		12 Vdc / Vac	Ø 36
	min. 1 - max 1 LED 4W			
	min. 1 - max 1 LED ZOOM			
	min. 1 - max 5 LED 1W		≥ 24 Vdc / Vac	
	min. 1 - max 2 LED 1W			
	min. 1 - max 1 LED ZOOM			

DIMMERABILI
DIMMABLE

 IP20

Vedi funzionamento dell'alimentatore dimmerabile multifunzione pag. 188
See operation instructions of the multifunction dimmable driver page 188

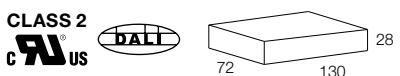
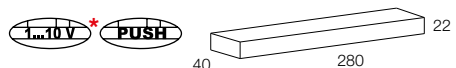
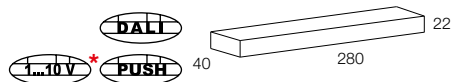
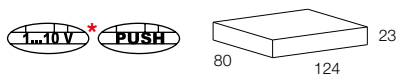
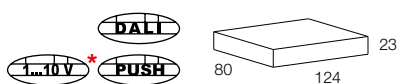
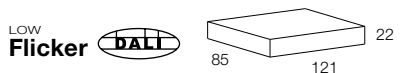
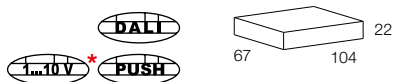

Code	nr. LED collegabili nr. of LEDs to connect	Vin	
CC10-M-350-N	min. 1 - max 1 LOLED 3W	110-240 Vac	Ø 58
CC18-C-350-N	min. 9 - max 16 LED 1W min. 1 - max 1 LED 12W min. 3 - max 5 LED 4W min. 2 - max 4 LED ZOOM	220-240 Vac	Ø 55
CC32-C-350-N IGBT-TRIAC PUSH	min. 1 - max 15 LED 1W min. 1 - max 1 LED 12W min. 1 - max 4 LED 4W min. 1 - max 3 LED ZOOM	220-240 Vac	Ø 54
CC32-D-350-N	min. 4 - max 16 LED 1W min. 1 - max 1 LED 12W min. 1 - max 4 LED 4W min. 1 - max 4 LED ZOOM	220-240 Vac	Ø 70
	min. 4 - max 14 LED 1W min. 1 - max 1 LED 12W min. 1 - max 3 LED 4W min. 1 - max 3 LED ZOOM	110-127 Vac	
CC32-M-350-N MULTIFUNZIONE	min. 4 - max 16 LED 1W min. 1 - max 1 LED 12W min. 1 - max 4 LED 4W min. 1 - max 4 LED ZOOM	220-240 Vac	Ø 70
	min. 4 - max 14 LED 1W min. 1 - max 1 LED 12W min. 1 - max 3 LED 4W min. 1 - max 3 LED ZOOM	110-127 Vac	
CC40-M-350-N	min. 5 - max 18 LED 1W min. 1 - max 1 LED 12W min. 2 - max 6 LED 4W min. 2 - max 4 LED ZOOM	120-277 Vac	Ø 38
CC40-D-350-N	min. 8 - max 18 LED 1W min. 1 - max 1 LED 12W min. 3 - max 6 LED 4W min. 2 - max 4 LED ZOOM	120-277 Vac	Ø 88
CC50-D-350-N DALI MULTIFUNZIONE	min. 1 - max 23 LED 1W min. 1 - max 2 LED 12W min. 1 - max 7 LED 4W min. 1 - max 6 LED ZOOM	110-240 Vac	Ø 82
CC50-M-350-N	min. 1 - max 23 LED 1W min. 1 - max 2 LED 12W min. 1 - max 7 LED 4W min. 1 - max 6 LED ZOOM	110-240 Vac	Ø 82
CC56-D-350-NU	min. 7 - max 30 LED 1W min. 1 - max 3 LED 12W min. 2 - max 10 LED 4W min. 2 - max 8 LED ZOOM	110-240 Vac	Ø 47
CC56-M-350-NU	min. 7 - max 30 LED 1W min. 1 - max 3 LED 12W min. 2 - max 10 LED 4W min. 2 - max 8 LED ZOOM	110-240 Vac	Ø 47
CC30-D-350-U	min. 1 - max 18 LED 1W min. 1 - max 1 LED 12W min. 1 - max 6 LED 4W min. 1 - max 4 LED ZOOM	110-240 Vac	Ø 78

* **POTENZIOMETRO**
POTENTIOMETER

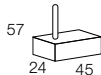

97000288

ALIMENTATORI 500mA LED DRIVERS

USE WITH: 2W - 2x2W - 6W - 16W - 18W

NON DIMMERABILI NON-DIMMABLE

			nr. LED collegabili		
			nr. of LEDs to connect	Vin	
IP20	CLASS 2 	 31 52 22	CC6-F-500-S	min. 1 - max 3 LED 2W 100-240 Vac	Ø 36
IP20		 52 111 22	CC20-F-500-N	min. 1 - max 10 LED 2W min. 1 - max 3 LED 6W min. 1 - max 1 LED 16W min. 1 - max 1 LED 18W	Ø 55
		 80 124 23	CC50-F-500-N	min. 1 - max 22 LED 2W min. 1 - max 5 LED 6W min. 1 - max 2 LED 16W min. 1 - max 2 LED 18W	Ø 82

DRIVERS IP67

			nr. LED collegabili		
			nr. of LEDs to connect	Vin	
IP67 With box A00294,30 page 207	CLASS 2 	 35 118 26	CC18-F-500-P	min. 1 - max 9 LED 2W min. 1 - max 2 LED 6W	90-264 Vac Ø 45
Trailing Edge Dimming 	CLASS 2 	 40 134 31	CC26-C-500-P	min. 1 - max 1 LED 18W min. 1 - max 4 LED 6W min. 4 - max 16 LED 2W	220-240 Vac Ø 50

Dimmerabile con taglio di fine fase.
Trailing edge dimmable drivers.

PER IMBARCAZIONI FOR BOATS

			nr. LED collegabili		
			nr. of LEDs to connect	Vin	
IP20		 32 51 22	CC15-F-500-NB	min. 1 - max 3 LED 2W 12 Vdc	Ø 36
				min. 1 - max 6 LED 2W ≥ 24 Vdc	

DIMMERABILI
DIMMABLE

 IP20

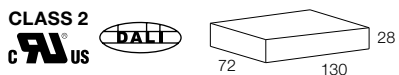
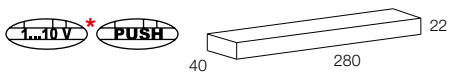
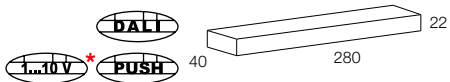
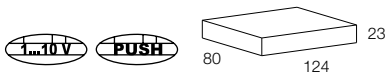
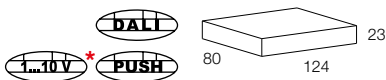
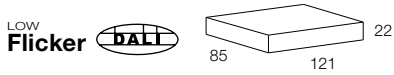
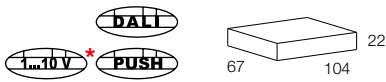

Vedi funzionamento dell'alimentatore dimmerabile multifunzione pag. 188
See operation instructions of the multifunction dimmable driver page 188

Code	nr. LED collegabili nr. of LEDs to connect	Vin	
CC20-C-500-N	min. 5 - max 13 LED 2W min. 2 - max 3 LED 6W min. 1 - max 1 LED 16W min. 1 - max 1 LED 18W	220-240 Vac	Ø 55
CC32-C-500-N IGBT+TRIAC PUSH	min. 1 - max 12 LED 2W min. 1 - max 3 LED 6W min. 1 - max 1 LED 16W min. 1 - max 1 LED 18W	220-240 Vac	Ø 54
CC32-D-500-N	min. 2 - max 14 LED 2W min. 1 - max 4 LED 6W min. 1 - max 1 LED 16W min. 1 - max 1 LED 18W	220-240 Vac	Ø 70
	min. 2 - max 10 LED 2W min. 1 - max 2 LED 6W	110-127 Vac	
CC32-M-500-N MULTIFUNZIONE	min. 2 - max 14 LED 2W min. 1 - max 4 LED 6W min. 1 - max 1 LED 16W min. 1 - max 1 LED 18W	220-240 Vac	Ø 70
	min. 2 - max 10 LED 2W min. 1 - max 2 LED 6W	110-127 Vac	
CC40-D-500-N	min. 8 - max 18 LED 2W min. 2 - max 4 LED 6W min. 1 - max 1 LED 16W min. 1 - max 1 LED 18W	120-277 Vac	Ø 88
CC40-M-500-N	min. 5 - max 18 LED 2W min. 2 - max 4 LED 6W min. 1 - max 1 LED 16W min. 1 - max 1 LED 18W	120-277 Vac	Ø 88
CC50-D-500-N DALI MULTIFUNZIONE	min. 1 - max 22 LED 2W min. 1 - max 5 LED 6W min. 1 - max 2 LED 16W min. 1 - max 2 LED 18W	110-240 Vac	Ø 82
CC50-M-500-N	min. 1 - max 22 LED 2W min. 1 - max 5 LED 6W min. 1 - max 2 LED 16W min. 1 - max 2 LED 18W	110-240 Vac	Ø 82
CC56-D-500-NU	min. 5 - max 28 LED 2W min. 2 - max 7 LED 6W min. 1 - max 2 LED 16W min. 1 - max 2 LED 18W	220-240 Vac	Ø 47
	min. 5 - max 26 LED 2W min. 2 - max 6 LED 6W min. 1 - max 2 LED 16W min. 1 - max 2 LED 18W	110-127 Vac	
CC56-M-500-NU	min. 5 - max 28 LED 2W min. 2 - max 7 LED 6W min. 1 - max 2 LED 16W min. 1 - max 2 LED 18W	220-240 Vac	Ø 47
	min. 5 - max 26 LED 2W min. 2 - max 6 LED 6W min. 1 - max 2 LED 16W min. 1 - max 2 LED 18W	110-127 Vac	
CC30-D-500-U	min. 1 - max 17 LED 2W min. 1 - max 4 LED 6W min. 1 - max 1 LED 16W min. 1 - max 1 LED 18W	110-240 Vac	Ø 78

* **POTENZIOMETRO**
POTENTIOMETER



97000288

ALIMENTATORI 700mA LED DRIVERS

USE WITH: 2W - 9W - 20W - 25W

NON DIMMERABILI NON-DIMMABLE

 IP20

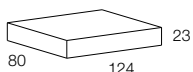
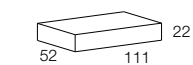

Code	nr. LED collegabili nr. of LEDs to connect	Vin	
CC20-F-700-N	min. 1 - max 2 LED 9W min. 1 - max 9 LED 2W	220-240 Vac	Ø 55
CC50-F-700-N	min. 1 - max 5 LED 9W min. 1 - max 1 LED 25W min. 1 - max 22 LED 2W	220-240 Vac	Ø 82
	min. 1 - max 4 LED 9W min. 1 - max 1 LED 25W min. 1 - max 19 LED 2W	110-127 Vac	

DRIVERS IP67

 IP67

With box
A00294.30
page 207

CLASS 2

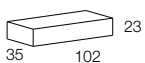
Trailing Edge Dimming

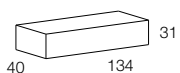

Code	nr. LED collegabili nr. of LEDs to connect	Vin	
CC18-F-700-P	min. 1 - max 2 LED 9W min. 1 - max 9 LED 2W	220-240 Vac	Ø 45
CC36-C-700-P	min. 1 - max 4 LED 9W min. 1 - max 1 LED 25W min. 2 - max 16 LED 2W	220-240 Vac	Ø 50

DIMMERABILI DIMMABLE

 IP20

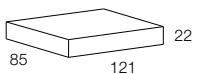
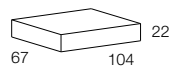
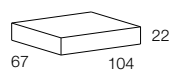
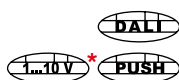
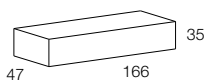

LOW Flicker

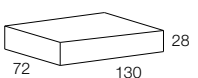
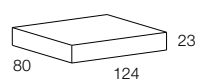
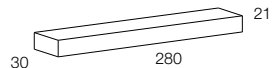

Vedi funzionamento dell'alimentatore dimmerabile multifunzione pag. 188
See operation instructions of the multifunction dimmable driver page 188

Code	nr. LED collegabili nr. of LEDs to connect	Vin	
CC32-C-700-N	min. 1 - max 3 LED 9W min. 1 - max 1 LED 25W min. 1 - max 14 LED 2W	220-240 Vac	Ø 54
CC32-D-700-N	min. 1 - max 3 LED 9W min. 1 - max 1 LED 25W min. 1 - max 14 LED 2W	220-240 Vac	Ø 70
	min. 1 - max 2 LED 9W min. 1 - max 7 LED 2W		
CC32-M-700-N	min. 1 - max 3 LED 9W min. 1 - max 1 LED 25W min. 1 - max 14 LED 2W	220-240 Vac	Ø 70
	min. 1 - max 2 LED 9W min. 1 - max 7 LED 2W	110-127 Vac	
CC40-D-700-N	min. 2 - max 4 LED 9W min. 1 - max 1 LED 25W min. 5 - max 18 LED 2W	120-277 Vac	Ø 88
CC40-M-700-N	min. 2 - max 4 LED 9W min. 1 - max 1 LED 25W min. 8 - max 18 LED 2W	120-277 Vac	Ø 38
CC50-D-700-N	min. 1 - max 5 LED 9W min. 1 - max 1 LED 25W min. 1 - max 22 LED 2W	220-240 Vac	Ø 82
	min. 1 - max 4 LED 9W min. 1 - max 1 LED 25W min. 1 - max 19 LED 2W	110-127Vac	
CC50-D-700-U	min. 1 - max 4 LED 9W min. 1 - max 1 LED 25W min. 1 - max 17 LED 2W	110-240Vac	Ø 78

* POTENZIOMETRO
POTENTIOMETER

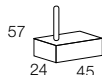

97000288

ALIMENTATORI 900mA LED DRIVERS

USE WITH: 3W - 35W

NON DIMMERABILI NON-DIMMABLE

IP20

CLASS 2
C_RUS

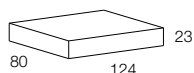
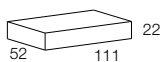

nr. LED collegabili

Code	nr. of LEDs to connect	Vin	
CC20-F-900-N	min. 1 - max 6 LED 3W	220-240 Vac	Ø 55
	min. 1 - max 4 LED 3W	110-127 Vac	
CC50-F-900-N	min. 1 - max 15 LED 3W min. 1 - max 1 LED 35W	220-240 Vac	Ø 82
	min. 1 - max 12 LED 3W min. 1 - max 1 LED 35W	110-127 Vac	

DIMMERABILI DIMMABLE

IP20

CLASS 2
C_RUS

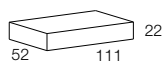

CLASS 2
C_RUS

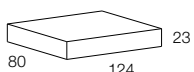
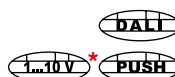
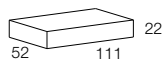

CLASS 2
C_RUS

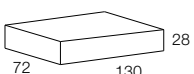

CLASS 2
C_RUS



Vedi funzionamento dell'alimentatore dimmerabile multifunzione pag. 188
See operation instructions of the multifunction dimmable driver page 188

nr. LED collegabili

Code	nr. of LEDs to connect	Vin	
CC20-D-900-N	min. 1 - max 6 LED 3W	220-240 Vac	Ø 55
	min. 1 - max 4 LED 3W	110-127 Vac	
CC20-M-900-N	min. 1 - max 6 LED 3W	220-240 Vac	Ø 55
	min. 1 - max 4 LED 3W	110-127 Vac	
CC50-D-900-N DALI MULTIFUNZIONE	min. 1 - max 15 LED 3W min. 1 - max 1 LED 35W	220-240 Vac	Ø 82
	min. 1 - max 12 LED 3W min. 1 - max 1 LED 35W	110-127 Vac	
CC30-D-900-U	min. 1 - max 15 LED 3W	110-240 Vac	Ø 78
CC50-D-900-U	min. 1 - max 15 LED 3W min. 1 - max 1 LED 35W	110-240 Vac	Ø 78

ALIMENTATORI 1200mA LED DRIVERS

USE WITH: 45W

NON DIMMERABILI NON-DIMMABLE

IP20

CLASS 2
C_RUS

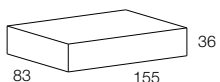

nr. LED collegabili

Code	nr. of LEDs to connect	Vin	
CC55-F-1200-NU	min. 1 - max 1 LED 45W	110-240 Vac	Ø 85

DIMMERABILI DIMMABLE

IP20

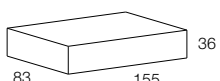
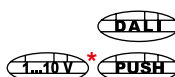

CLASS 2
C_RUS

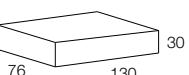

LOW
Flicker

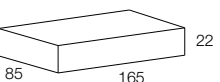

Vedi funzionamento dell'alimentatore dimmerabile multifunzione pag. 188
See operation instructions of the multifunction dimmable driver page 188

nr. LED collegabili

Code	nr. of LEDs to connect	Vin	
CC55-D-1200-N DALI MULTIFUNZIONE	min. 1 - max 1 LED 45W	110-240 Vac	Ø 85
CC50-D-1200-NU	min. 1 - max 1 LED 45W	120-277 Vac	Ø 82
CC50-D-1200-U	min. 1 - max 1 LED 45W	120-277 Vac	Ø 88

* POTENZIOMETRO
POTENTIOMETER

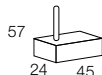

97000288

ALIMENTATORI 12Vdc - 24Vdc LED DRIVERS

DGA offre la possibilità di poter effettuare collegamenti elettrici in PARALLELO.

Il collegamento elettrico in parallelo semplifica moltissimo l'impianto elettrico (rispetto alla serie) e permette di collegare un grosso numero di apparecchi LED ad un solo Alimentatore 12Vdc - 24Vdc.

È possibile scegliere l'alimentatore più adatto a seconda delle sue caratteristiche tecniche:

- Potenza massima (WATT) LED collegabili
- Dimmerabile
- Grado di protezione IP67

Per i collegamenti in parallelo rispettare lo schema riportato in figura.

Some DGA fixtures have the possibility to be connected in PARALLEL.

The parallel connection simplify a lot the electric wiring (if compared to the series connection) and it makes possible the connection of a higher amount of LED fixtures to each single 12Vdc - 24Vdc driver.

It is possible to choose the most appropriate driver, according to its technical features:

- MAX power (in watt) of LEDs to connect
- Dimmable
- With IP67 protection rate

For parallel connections, please stick to the diagram of the picture.

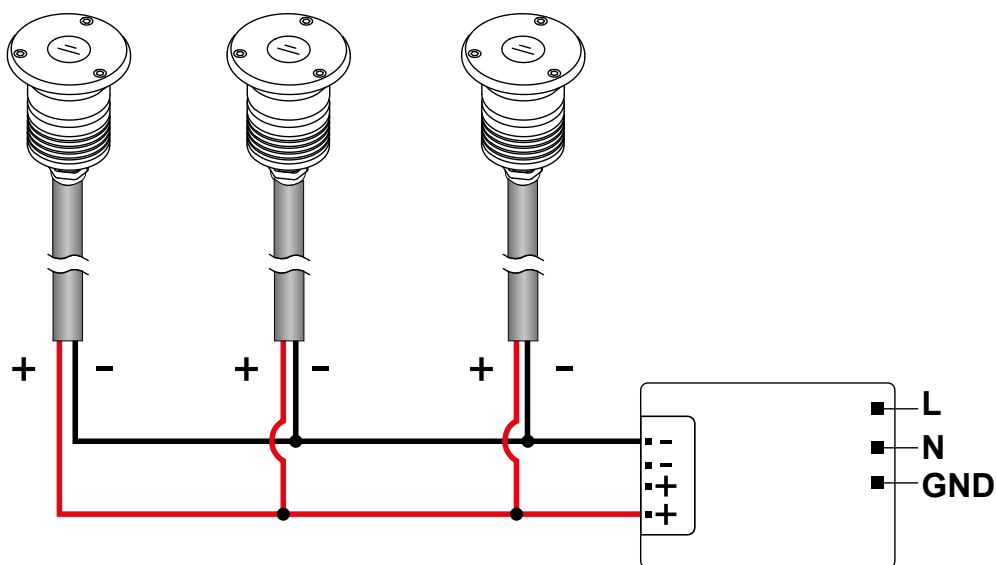

ALIMENTATORI 12Vdc - 24Vdc LED DRIVERS

DIMMER PER ALIMENTATORI 12Vdc - 24Vdc DIMMER FOR 12Vdc - 24Vdc DRIVERS

Collegando questo dispositivo è possibile rendere dimmerabili tutti gli alimentatori 12Vdc 24Vdc fissi.



Remote device which allows the 12Vdc 24Vdc fixed drivers to become dimmable.

Code	potenza MAX LED collegabili max power to be connected	Vin
DIMM-1CH da barra din din bar mounting	150W	12-24 Vdc

NON DIMMERABILI NON-DIMMABLE

IP20

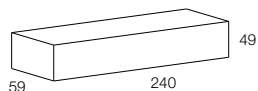
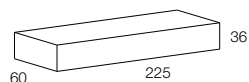
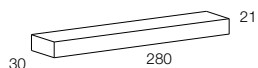
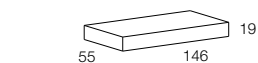

Code	potenza MAX LED collegabili max power to be connected	Vin	
CV20-F-24-N	10W - 0,4A max	100-120 Vac	Ø 58
	20W - 1A max	220-240 Vac	
CV20-F-12-N	10W - 0,83A max	100-120 Vac	Ø 58
	20W - 2A max	220-240 Vac	
CV60-F-24-N	60W - 2,5A max	220-240 Vac	Ø 38
CV70-F-24-N	70W - 2,9A max	220-240 Vac	Ø 70
CV70-F-12-N	70W - 5,8A max	220-240 Vac	Ø 70
CV150-F-24-N	150W - 6,25A max	220-240 Vac	Ø 78

DRIVERS IP67

IP67

CLASS 2

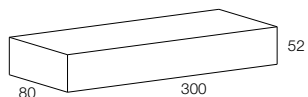
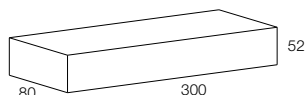
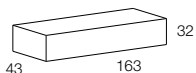
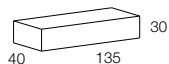

Code	potenza MAX LED collegabili max power to be connected	Vin	
CV25-F-24-P IP67 With box A00294,30 page 207	25W - 1,1A max	120-240 Vac	Ø 52
CV60-F-24-PU IP67 With box A00294,30 page 207	60W - 2,5A max	90-264 Vac	Ø 53
CV70-F-24-P	70W - 2,90A max	220-240 Vac	Ø 75
CV70-F-12-P	70W - 5,80A max	220-240 Vac	Ø 75
CV150-F-24-P	150W - 6,25A max	220-240 Vac	Ø 80

* POTENZIOMETRO
POTENTIOMETER

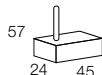

97000288

ALIMENTATORI 12Vdc - 24Vdc LED DRIVERS

DRIVERS IP65



IP65

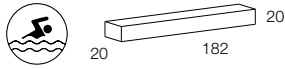

potenza MAX LED collegabili

Code	max power to be connected	Vin	
CV13-F-12-P	13W - 1,80A max	220-240 Vac	Ø 29

DIMMERABILI DIMMABLE



IP20

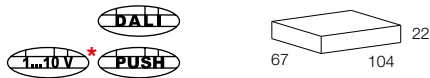
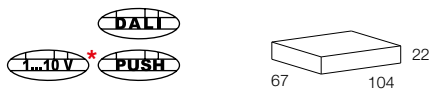

Vedi funzionamento dell'alimentatore dimmerabile multifunzione pag. 188
See operation instructions of the multifunction dimmable driver page 188

potenza MAX LED collegabili

Code	max power to be connected	Vin	
CV20-D-12-N	10W - 0,9A max	100-240 Vac	Ø 70

CV20-D-24-N	20W - 0,83A max	220-240 Vac	Ø 70
	15W - 0,62A max	110-120 Vac	

CV20-M-12-N	11W	110-240 Vac	Ø 70
-------------	-----	-------------	------

CV20-M-24-N	20W	220-240 Vac	Ø 70
	15W	110-127 Vac	

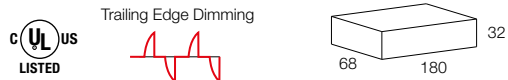

CV40-C-24-NU	40W	120 Vac	Ø 77
--------------	-----	---------	------

CV60-C-24-NU	60W	120 Vac	Ø 77
--------------	-----	---------	------

CV75-C-24-NU	75W	120 Vac	Ø 77
--------------	-----	---------	------

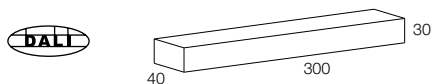
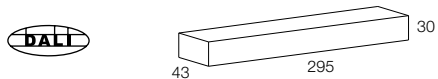

CV100-D-24-N	100W - 4,167A max	220-240 Vac	Ø 53
--------------	-------------------	-------------	------

CV120-D-24-N	120W - 5A max	220-240 Vac	Ø 51
--------------	---------------	-------------	------

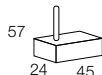

ALIMENTATORI 12Vdc - 24Vdc LED DRIVERS

DIMMERABILI DIMMABLE

 IP67



3 IN 1
DIMMING

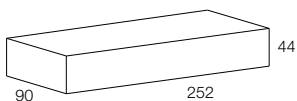
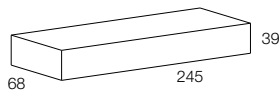
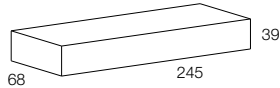

potenza MAX LED collegabili

Code	max power to be connected	Vin	
CV185-R-24-P	185W	90-305 Vac	Ø 77
CV240-R-24-P	240W	90-305 Vac	Ø 77
CV320-R-24-P	320W	90-305 Vac	Ø 77
CV185-R-12-P	156W	90-305 Vac	Ø 77
CV240-R-12-P	192W	90-305 Vac	Ø 77
CV320-R-12-P	264W	90-305 Vac	Ø 77

CONVERTITORI 24V LED CONVERTERS



 IP40

Code	OUT	per LED use with	nr. LED collegabili nr. of LEDs to connect	Vin
CC9-F-350-NB	350mA	1W	min. 1 - max 6	24 Vdc
CC14-F-500-NB	500mA	2W 4W	min. 1 - max 4 min. 1 - max 2	24 Vdc
CC14-F-700-NB	700mA	6W 14W	min. 1 - max 2 min. 1 - max 1	24 Vdc 24 Vdc

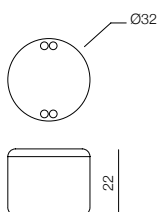

 IP65

Code	OUT	per LED use with	nr. LED collegabili nr. of LEDs to connect	Vin
CC9-F-350-PB	350mA	1W	min. 1 - max 6	24 Vdc
CC14-F-500-PB	500mA	2W 4W	min. 1 - max 4 min. 1 - max 2	24 Vdc
CC14-F-700-PB	700mA	6W 14W	min. 1 - max 2 min. 1 - max 1	24 Vdc 24 Vdc

I convertitori elettronici sono dimmerabili se pilotati da alimentatori 24 V dimmerabili.
Electronic converters can be dimmable only if powered by 24 V dimmable drivers.

ALIMENTATORI RGB LED DRIVERS

Il dispositivo CC36-X-350-N è studiato per il pilotaggio, l'alimentazione e il controllo di apparecchi di illuminazione a LED con tecnologia RGB (non idoneo per linea IRIDE). Il driver è dotato di uscite per pilotare apparecchi a LED controllati in corrente. Il collegamento viene effettuato con 6 fili (+R-R,+G-G,+B-B).

Per l'esecuzione di sequenze di cambi di colore dinamici, il dispositivo consente le seguenti modalità di funzionamento:

- La modalità "stand-alone", che con la funzione "Easy-Run-Menu" consente di scegliere una sequenza (show) fra quelle già residenti nella memoria del dispositivo e di riprodurla con una velocità selezionabile a piacere. È possibile collegare il dispositivo ad un pulsante remoto per attivare manualmente l'esecuzione della sequenza selezionata.

- È possibile sincronizzare altre unità senza alcuna connessione di controllo fra i vari dispositivi. In tal caso la sincronizzazione è affidata ai quarzi interni, ed è necessario che tutti gli apparecchi siano collegati ad un'unica linea di alimentazione e che vengano selezionati lo stesso show e la stessa velocità di esecuzione su ogni dispositivo. Grazie all'interfaccia compatibile con il protocollo USITT DMX 512(1990) è possibile:

a) asservire il funzionamento del dispositivo ad un'unità di controllo o ad un recorder esterno DMX, facendo eseguire qualsiasi programma.

b) Inserire il prodotto in una configurazione DMX con connessioni a catena (daisy-chain), collegando altri dispositivi DMX attraverso i connettori in/out.

The CC36-X-350-N device has been designed for piloting, powering and controlling of LED lighting equipment with RGB (not appropriate for IRIDE line).

The driver is equipped with outputs for piloting LED fixtures controlled by current. The connection is carried out with 6 wires (+R-R,+G-G,+B-B). To carry out colour dynamic change sequences, the device has the following function modes:

- The "stand-alone" mode, which thanks to the "Easy-Run-Menu" function, allows a sequence (show) to be chosen from those already stored in the memory of the device and to reproduce it with a desired selectable speed. The device can be connected to a remote push button to manually activate the execution of the selected sequence.

- It is possible to synchronize other units without any control connection between the various devices. In this case the synchronization is entrusted to the internal quartzes, and all the devices have to be connected to a single power supply and the same show and the same running speed have to be selected on each device. Thanks to the interface which is compatible with the USITT DMX 512(1990) protocol it is possible:

a) to interlock the function of the device to a control unit or an external DMX recorder, executing any program.

b) insert the product in a DMX configuration with chain connections (daisy-chain), connecting other DMX devices through the in/out connectors.

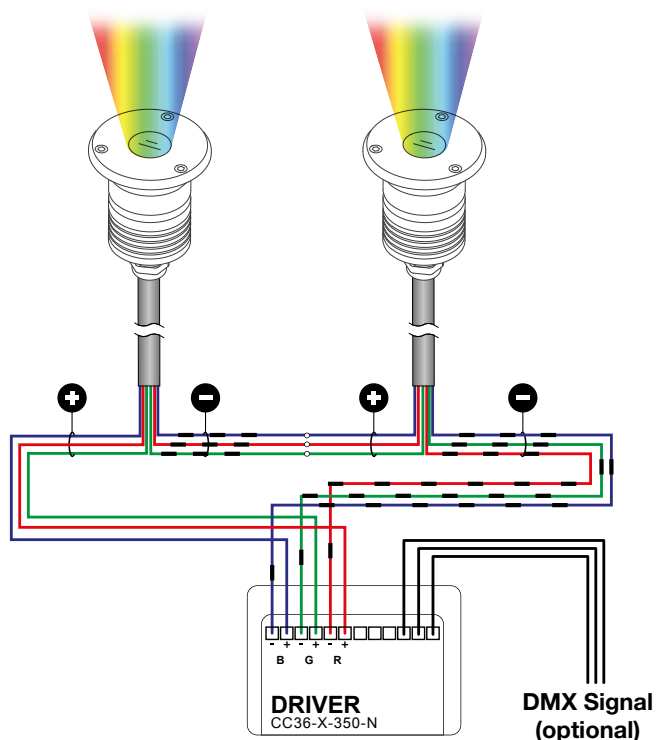
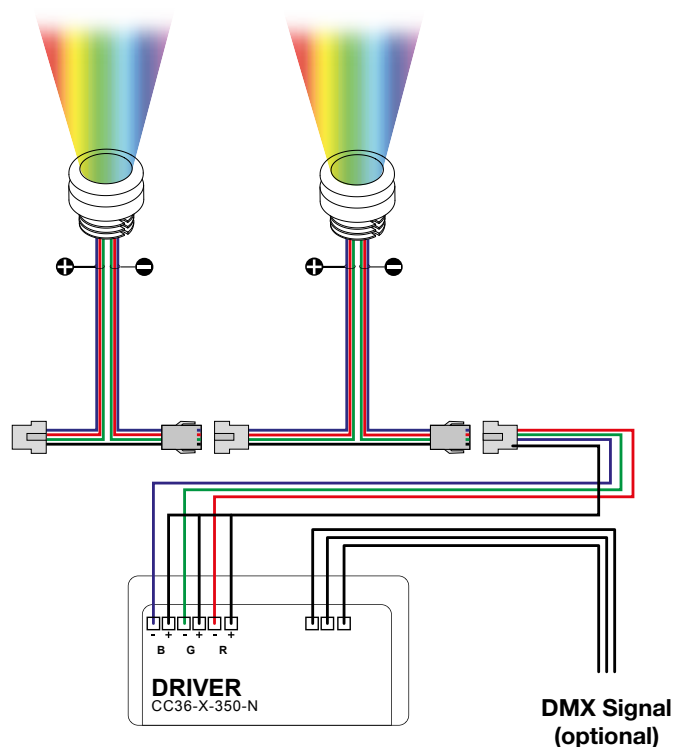

IP20

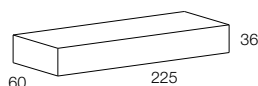

Code	nr. Apparecchi RGB collegabili nr. of RGB fixtures to connect	Vin	Dimensions
CC36-X-350-N	min. 1 - max 10	220-240 Vac	mm 60 x 225 x 36 h

Possibilità di pilotaggio e gestione RGB con centralina e/o interfaccia DMX 512.
Possibility of driving and controlling RGB with DMX 512 controller and/or interface.

ALIMENTATORI RGB LED DRIVERS

L'alimentatore CC30-Y-350-N permette il funzionamento e l'accensione degli apparecchi DGA RGB (non idoneo per linea IRIDE).

L'alimentatore ha delle funzioni integrate, e la variazione dei colori della luce emessa dai faretti è gestibile tramite un pulsante (non incluso).

FUNZIONAMENTO DEL PULSANTE:

Comandi della luce: Pressione breve = accende/spegne - Pressione continua = cambiano i colori, sempre uguali ma sempre diversi.

Effetto memoria (senza scollegare l'alimentazione sul Primario): l'apparecchio all'accensione visualizza l'ultimo colore impostato. Una doppia pressione in rapida successione porta tutti i colori al massimo (bianco).

Dopo una pressione continua (>20 sec) i colori continuano a cambiare anche rilasciando il tasto. Una pressione breve blocca il ciclo.

Our CC30-Y-350-N driver permits to turn on the RGB fixtures (not appropriate for IRIDE line).

The driver is provided with an on-board electronics, which permits the colours changing through a push button (not included).

FUNCTIONING OF THE PUSH BUTTON:

Light controls: Short touch= switch on/switch off - Prolonged touch= the light colour changing starts.

Memory function (without disconnecting the main voltage): switching on the system, the light colour is the last previously selected.

Make a short double touch to have all colours at 100% in order to obtain a white colour.

After a prolonged touch (over 20 sec.), colours go on changing automatically - By a short touch, the colour cycle is interrupted.

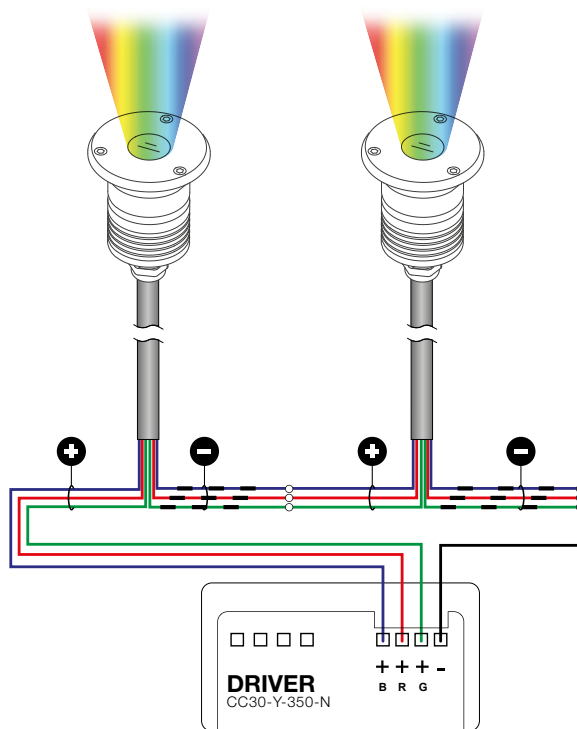
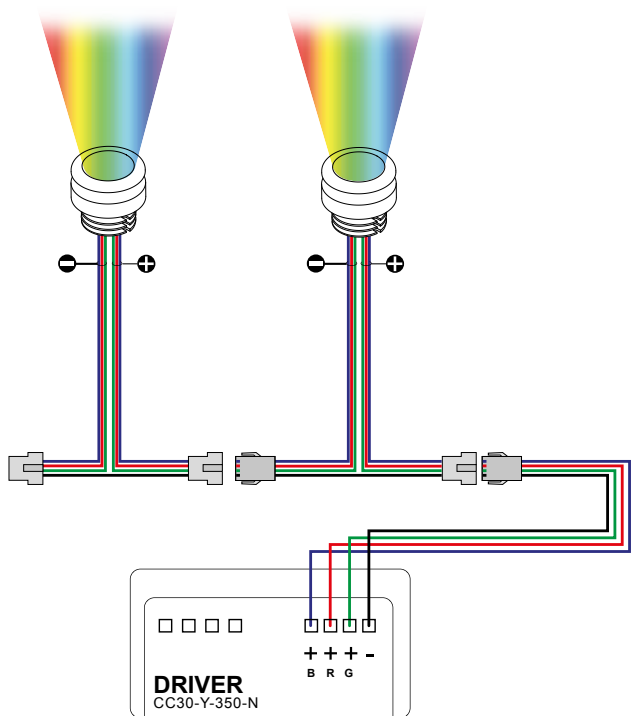

203

IP20

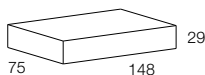

Code	nr. Apparecchi RGB collegabili nr. of RGB fixtures to connect	Vin	Dimensions
CC30-Y-350-N	min. 1 - max 9	190-260 Vac	mm 75 x 148 x 29 h

CONTROCASSA UNIVERSALE

UNIVERSAL RECESSED BOX

Controcassa universale in materiale plastico per faretti da incasso, per installazione in strutture di cemento armato e muratura. La controcassa, se necessario, può essere usata unitamente all'alloggiamento per il trasformatore.

Griglie con struttura rotonda o quadrata consentono in fase di finitura di definire esattamente la dimensione del foro in base alle misure dell'apparecchio.

Installazione su calcestruzzo - Installation in concrete



Fissare la controcassa universale sulla cassaforma di armatura nel punto dove il faretto sarà installato. Dopo la colata di calcestruzzo e al disarmo troveremo il foro della scatola nel soffitto.

Fix the universal box on the formwork, in the place where the spotlight will be installed.

After the pouring of the concrete and the consequently form removal, we will find the box hole into the ceiling.



Applicare le griglie per controcassa e tagliarle a seconda del foro di incasso previsto dall'apparecchio. Rasare con colla da piastrelle o normale stucco da cartongesso.

Attenzione: non usare l'intonaco a calce e cemento direttamente sulla griglia, ma effettuare la rasatura come supporto aggrappante.

Mount the grills on the universal box and cut them according to the cut-out of the spotlight. Then level the surface with tile glue or with simple plaster.

Attention: do not use cement coating directly on the grill, but level first to increase the bonding capability.



Universal plastic box for recessed spotlights, suitable for installation in reinforced concrete and brick structures. The box, if necessary, can be used together with the appropriate driver case. Grills with round or square shape permit, during the refining phase, to define exactly the dimension of the hole according to the dimension of the fixture to install.

Installazione su muratura - Installation in brickwork



L'operatore edile eseguirà i fori sul laterizio con massima precisione.

The mason will make the holes on the hollow bricks with extreme precision.



Fissare la controcassa con schiuma poliuretana o malta cementizia ad indurimento rapido, attenderne l'essiccazione.

La schiuma poliuretana va usata in minima quantità, ed è consigliabile applicarla con l'apposita pistola per evitare sprechi.

Fix the box with polyurethane foam or fast drying mortar, and wait for its drying.

The polyurethane foam has to be used in minimum quantity, and it is better to apply it with the appropriate gun in order to avoid wastes



Provvedere alla stuccatura della scatola prima del conclusivo intonaco.

Be sure to make a good filling of the box before applying the final coating.

CONTROCASSA UNIVERSALE

UNIVERSAL RECESSED BOX

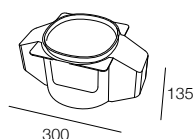

Code	Material	Description
A00340.70	Plastico Plastic	Controcassa universale per soffitto in cemento armato o mattone forato per faretti h max 120 mm Universal recessed box for concrete or hollow brick ceiling for fixture h max 120 mm



Code	Material	Description
A00341.70	Plastico Plastic	Griglia per controcassa universale per faretti con foro quadrato da 18x18 mm fino a 98x98 mm Grill for universal recessed box for fixtures with square cut out from 18x18 mm to 98x98 mm



Code	Material	Description
A00342.70	Plastico Plastic	Griglia per controcassa universale per faretti con foro tondo da Ø18 mm fino a Ø98 mm Grill for universal recessed box for fixtures with round cut out from Ø18 mm to Ø98 mm

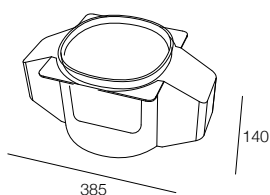

Code	Material	Description
A00390.70	Plastico Plastic	Controcassa universale per soffitto in cemento armato o mattone forato per faretti h max 130 mm Universal recessed box for concrete or hollow brick ceiling for fixture h max 130 mm

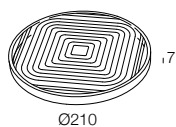

Code	Material	Description
A00391.70	Plastico Plastic	Griglia per controcassa universale per faretti con foro quadrato da 18x18 mm fino a 138x138 mm Grill for universal recessed box for fixtures with square cut out from 18x18 mm to 138x138 mm

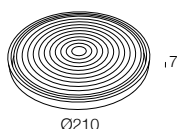

Code	Material	Description
A00392.70	Plastico Plastic	Griglia per controcassa universale per faretti con foro tondo da Ø18 mm fino a Ø210 mm Grill for universal recessed box for fixtures with round cut out from Ø18 mm to Ø210 mm

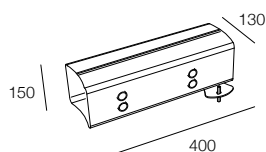

Code	Material	Description
A00383.70	Plastico Plastic	Scatola per alimentatore per controcasse universali Driver case for universal recessed boxes

CENTRALINE DMX CONTROLLERS

CENTRALINA DMX PER PC

Indicata per applicazioni dove semplicità e affidabilità sono i due requisiti più importanti.

La centralina viene fornita già settata con alcuni effetti RGB e può essere programmata con il software a corredo.

La PC DMX è la scelta perfetta per piccole applicazioni con meno di 128 canali DMX. È provvista di una memoria indipendente con un massimo di 30 programmazioni (128 canali) e di 8 porte per l'ingresso di contatti a secco.

La sua semplicità lo rende un prodotto molto affidabile.

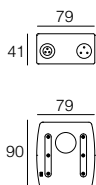

DMX CONTROLLER FOR PC

Suitable for applications where simplicity and reliability are very important.

The controller comes pre loaded with RGB effects and can be programmed by the software provided with the controller.

The PC DMX is the perfect product for small applications with less than 128 DMX channels. It offers a standalone memory with a maximum of 30 steps (128 channels) as well as 8 ports for dry contacts triggering.

Because of its simplicity this interface is extremely reliable.

Code	Description
PC DMX	Centralina DMX per PC DMX controller for PC

CENTRALINA DMX TOUCH SENSITIVE

Illuminare in punta di dita

TDMX ha caratteristiche straordinarie che comprendono 1024 canali DMX, pannello touch sensitive, orologio/calendario, programmazione remota, collegamento Ethernet, e molto altro....

È sufficiente avvitare la piastra posteriore del TDMX ad una presa a muro singola o doppia, collegare l'alimentatore e i cavi DMX al blocco connettori del TDMX, e agganciare la centralina al muro.

TDMX supporta fino a 5 Aree su un'ampiezza di 25 pagine. Questo permette di suddividere una stanza o un edificio e creare fino a 5 scenari diversi contemporaneamente. Un possibile esempio è il seguente:

Area A: Controllo sulla luce d'ambiente di una stanza, ad esempio alcuni singoli canali.

Area B: Un leggero effetto di cambio colore sui faretto LED installati a soffitto.

Area C: Vari colori statici sull'illuminazione a suolo.

Area D: Controllo degli apparecchi a parete.

Area E: Una funzione globale che interrompe tutte le altre e controlla tutto il sistema.

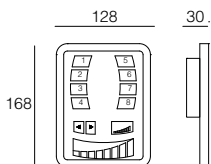

DMX CONTROLLER FOR PC TOUCH SENSITIVE

Lighting at the tip of your fingers

TDMX comes with amazing features such as 1024 DMX channels, touch sensitive panel, clock/calendar, remote control, Ethernet facilities, and much more....

Simply screw the TDMX's back plate onto a single or double gang wall socket, connect the power and DMX cables to the TDMX's block connector, then clip the TDMX onto the wall.

The TDMX supports up to 5 Areas across 25 pages. This allows you to split up a room or a building and play up to 5 different scenes simultaneously. For example, you could have:

Area A: Control over the ambient lighting of a room, such as some single channel

Area B: A subtle colour changing effect playing on LED spot in the ceiling

Area C: Some static colours used on floor lighting

Area D: Control of the wall lighting

Area E: A global override which controls everything

Code	Description
T DMX	Centralina DMX touch sensitive DMX touch sensitive controller

CENTRALINA E DMX

Bellezza, semplicità e controllo in un unico apparecchio

Disponibile nei colori bianco e nero, la EDMX è una soluzione semplice ma potente per il controllo degli apparecchi RGB.

La EDMX è uno dei ritrovamenti più interessanti nel mercato dell'illuminazione architettonica. La centralina è fornita già settata con alcuni effetti RGB e può essere facilmente programmata grazie al software fornito a corredo.

Caratteristiche tecniche:

- Centralina Stand Alone DMX512 con display in vetro
- 3 pulsanti touch-sensitive, semplici da usare
- Creazione tramite semplici passaggi di scenari dinamici di durata regolabile
- Regolazione diretta dell'intensità e del colore di una scena
- Programmabile con cavetto USB (a corredo) e software di programmazione
- Connettore posteriore a 5 ingressi : 3 x DMX - 2x alimentazione
- Collegare a adattatore 5-12V AC/DC (non incluso)
- 128 canali DMX

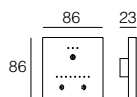
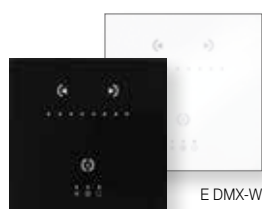

E DMX CONTROLLER

Beauty, simplicity and control joined together.

Available in black and white, the EDMX provides a simple yet powerful solution for your RGB lighting control needs.

The EDMX is one of our most exciting development within the architectural market. The controller comes pre loaded with RGB effects and can be programmed by the software provided with the controller.

The unit features:

- DMX512 Stand Alone Controller with a glass display
- 3 touch sensitive buttons for simplicity and reliability
- dynamic scenes created step by step with adjustable timing
- live setting of the intensity and colour of a scene
- programmable with the included USB cable and control software
- 5-pin connector block at the rear : 3x DMX - 2x Power Supply
- works with 5-12V AC/DC adapter (optional)
- 128 DMX channels

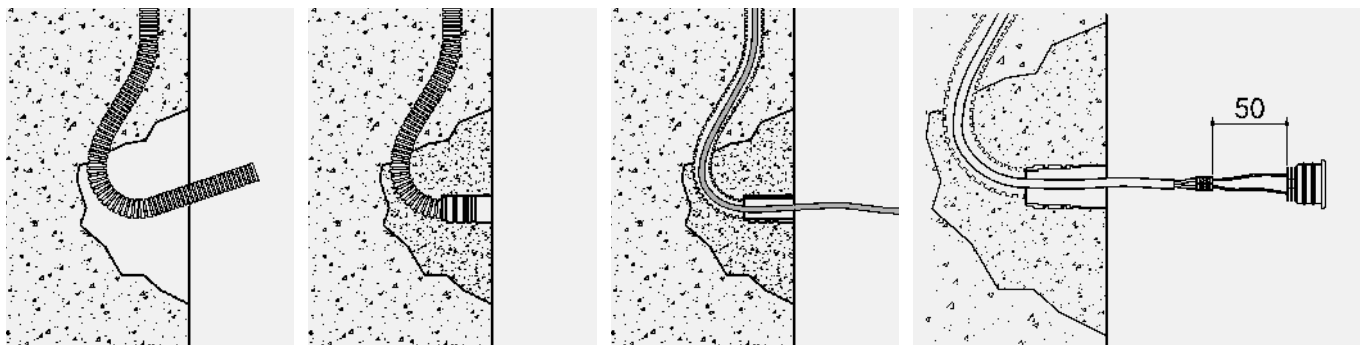

Code	Description
E DMX-B	Centralina DMX touch sensitive - colore nero DMX touch sensitive controller - colour black
E DMX-W	Centralina DMX touch sensitive - colore bianco DMX touch sensitive controller - colour white

CASSEFORME HOUSINGS







Installazione a parete o pavimento con parete nuda.
Wall or ground installation, plain wall.

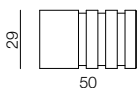



Code	Material	Cut-out	Use with:
A00283.30	Alluminio Aluminum	 Ø 19 mm	 Gemma 20 i page 42

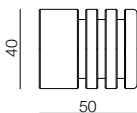

Code	Material	Cut-out	Use with:
A00102.30	Alluminio Aluminum	 Ø 30 mm	 Gemma 30 i page 43  Gemma 30 iR page 46  Gemma Qd 35 i page 47  Lui page 51  Lei page 53



Code	Material	Cut-out	Use with:
A00103.30	Alluminio Aluminum	 Ø 42 mm	 Gemma 50 i page 50

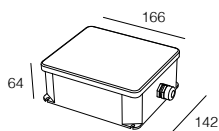

Code	Description
A00294.30	Scatola di derivazione in alluminio IP67 Aluminum junction Box IP67

CONTROCASSE RECESSED BOXES

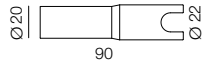

Code	Material	Cut-out	Use with:
------	----------	---------	-----------

A00285.30

Alluminio
Aluminum

Ø 23 mm



Gemma 20 IP67
page 85

A00285.40

Materiale
plastico
Plastic
material

Gemma 20 IP68
page 127

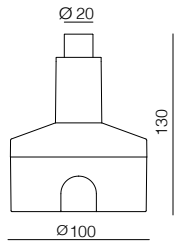

A00326.40

Materiale
plastico
Plastic
material

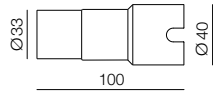

A00161.30

Alluminio
Aluminum

Ø 40 mm



Gemma 35 IP67
page 86



Gemma Qd 35 IP67
page 87

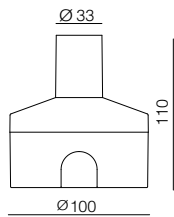

A00249.40

Materiale
plastico
Plastic
material



Lui IP65
page 111



Lei IP65
page 113

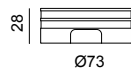

A00247.30

Alluminio
Aluminum

Ø 74 mm



Astro 80
page 88



Astro Qd 80
page 89

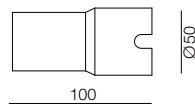

A00129.30

Alluminio
Aluminum

Ø 50 mm



Arco 50 iL
page 119



Arco 60 i
page 91

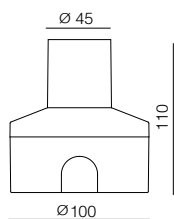



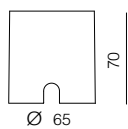

A00250.40

Materiale
plastico
Plastic
material

CONTROCASSE RECESSED BOXES



Code	Material	Cut-out	Use with:
------	----------	---------	-----------

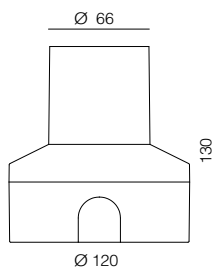

A00290.40	Materiale plastico Plastic material	 Ø 68 mm	 Nesis H65 page 92  Nesis H65 Am page 93  Nesis H65 IP68 page 133
-----------	--	--	---



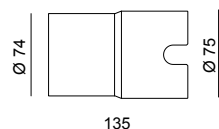

A00251.40	Materiale plastico Plastic material		
-----------	--	--	--



A00130.40	Materiale plastico Plastic material	 Ø 76 mm	 Giove 3S R page 100
-----------	--	--	--

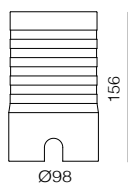



A00333.40	Materiale plastico Plastic material	 Ø 98 mm	 Giove 7S R page 101
-----------	--	--	--



A00216.30	Alluminio Aluminum		 Aura 6-8 page 94
-----------	-----------------------	--	---

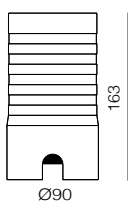
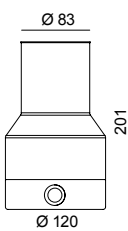
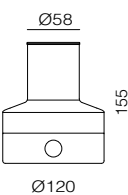

A00204.30	Alluminio Aluminum		 Aura 12 page 97  Iride 3 i page 164
-----------	-----------------------	--	---

A00276.40	Materiale plastico Plastic material	 Ø 92 mm	 Iride 3 IP68 i page 136
-----------	--	--	--



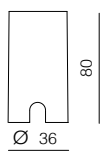

CONTROCASSE RECESSED BOXES

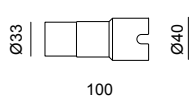

Code	Material	Cut-out	Use with:
A00409.40	Materiale plastico Plastic material	 Ø 37 mm	 Ridi page 117



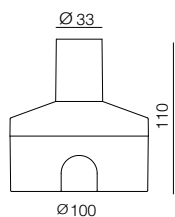

A00231.30	Alluminio Aluminum	 Ø 40 mm	 Gemma 35 IP68 page 128
-----------	-----------------------	--	---

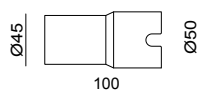

A00249.40	Materiale plastico Plastic material		
-----------	--	--	--



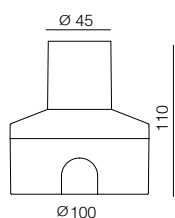

A00230.30	Alluminio Aluminum	 Ø 50 mm	 Arco 60 IP68 page 131
-----------	-----------------------	---	---

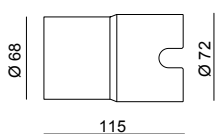

A00250.40	Materiale plastico Plastic material		
-----------	--	--	--



A00243.40	Materiale plastico Plastic material	 Ø 73 mm	 Arco 80 IP68 page 134
-----------	--	--	--

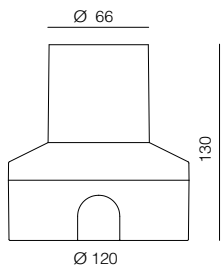

A00251.40	Materiale plastico Plastic material		
-----------	--	--	--

CONTROCASSE QUADRE SQUARE RECESSED BOXES

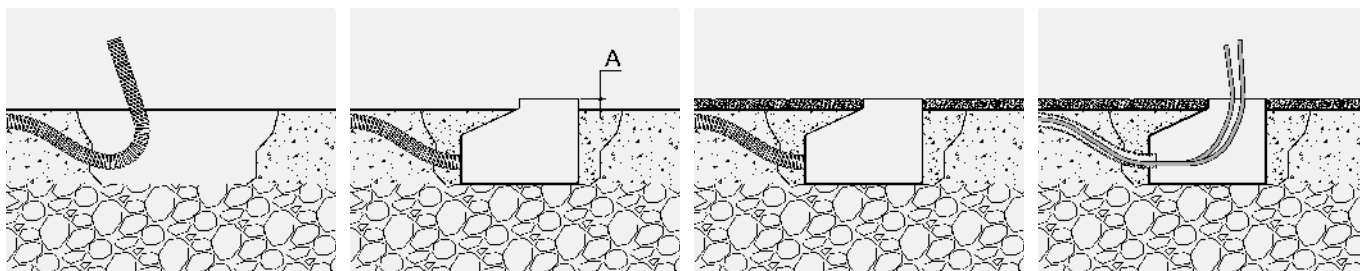

Installazione a parete o pavimento.
Wall or ground installation.

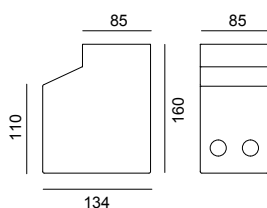

Code	Material	Use with:
A00246.30	Ferro zincato Galvanized steel	Geo 6-8 R page 104



Geo 6-8 R
page 104

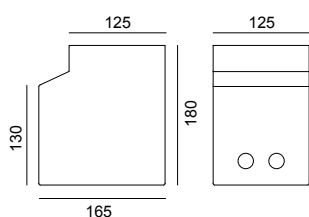

Code	Material	Use with:
A00217.30	Ferro zincato Galvanized steel	Geo 12 R page 105



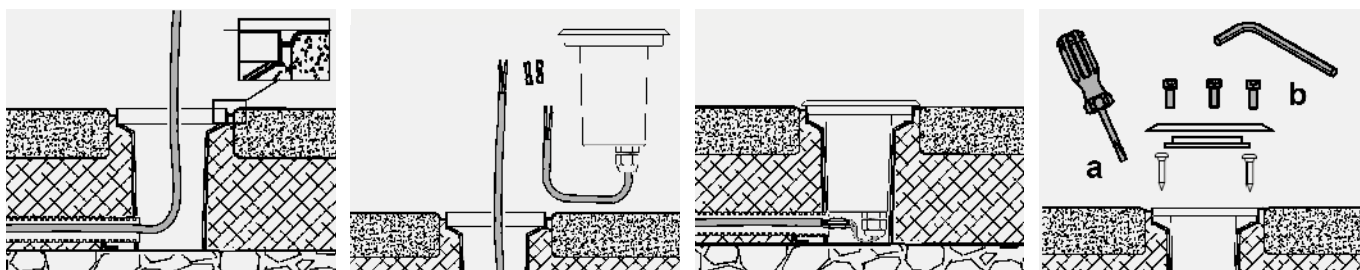

Geo 12 R
page 105

CONTROCASSE RECESSED BOXES

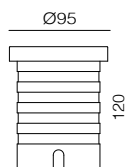

Installazione a parete o pavimento.
Wall or ground installation.



Code	Material	Cut-out	Use with:
A00468.40	Materiale plastico Plastic material	 Ø 96 mm	 Discovery page 121



Discovery
page 121

CONNETTORI STAGNI IP68 WATERTIGHT CONNECTORS IP68

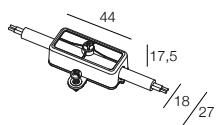
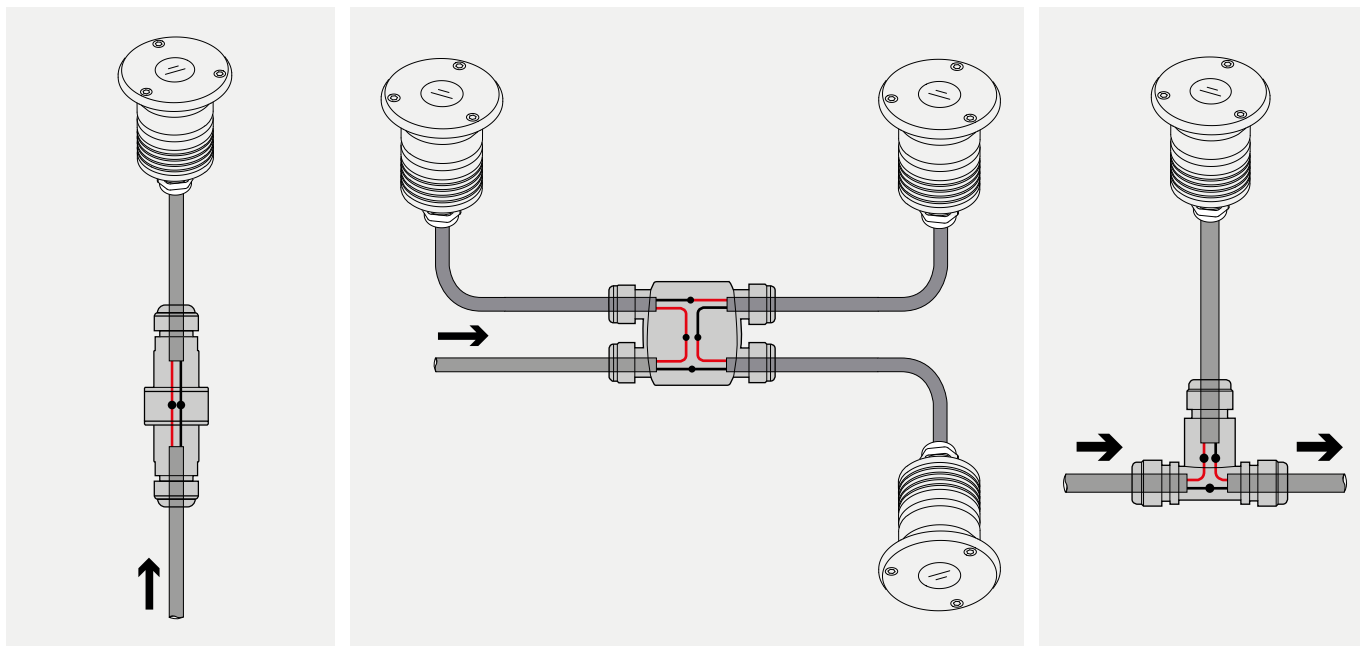

Code	Material	Description
A00357.40	Plastico Plastic	Micro connettore stagno Micro watertight connector IP68 - CABLE Ø4,8mm ÷ Ø6mm Section 2x2,5mm

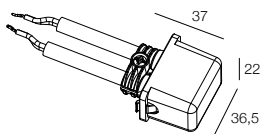

Code	Material	Description
A00387.40	Plastico Plastic	Connettore stagno Watertight connector IP68 - CABLE Ø6mm ÷ Ø8mm Section 2x1,5mm

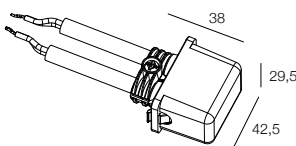

Code	Material	Description
A00388.40	Plastico Plastic	Connettore stagno Watertight connector IP68 - CABLE Ø6mm ÷ Ø8mm Section 3x1,5mm

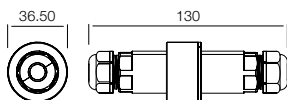

Code	Material	Description
A00153.40	Plastico Plastic	Connettore stagno IP68 lineare Linear watertight connector IP68

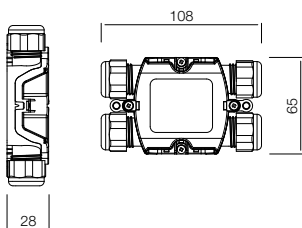

Code	Material	Description
A00154.40	Plastico Plastic	Connettore stagno IP68 lineare multiplo 4 ingressi Linear watertight connector IP68 - 4 inputs

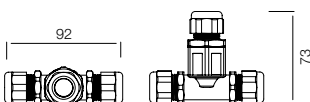

Code	Material	Description
A00155.40	Plastico Plastic	Connettore "T" IP68 IP68 "T" connector

ACCESSORI ACCESSORIES



Code	Description	Use with:
A00277.60	Picchetto in acciaio Inox AISI 316L Stainless Steel 316L stake	Micro page 140
A00277.F0	Picchetto in ferro zincato Galvanized steel stake	Micro IP68 page 141

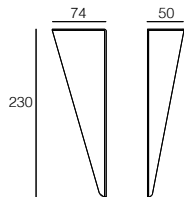

Code	Description	Use with:
A00281.60	Picchetto in acciaio Inox AISI 316L Stainless Steel 316L stake	Quantum P page 145
A00281.F0	Picchetto in ferro zincato Galvanized steel stake	Sirio Series page 149

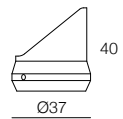

Code	Description	Use with:
A00323.30	Grigio - Gray Visiera antiabbagliamento Low glare visor	Micro page 140
A00323.40	Nero - Black	
A00323.E0	Ottono - Brass	



A00323.60	Acciaio Inox - Stainless Steel Visiera antiabbagliamento Low glare visor	Micro IP68 page 141
-----------	---	------------------------

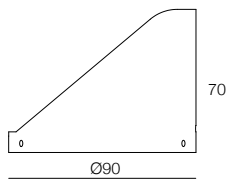

Code	Description	Use with:
A00420.30	Grigio - Gray Visiera antiabbagliamento Low glare visor	Quantum P page 145
A00420.40	Nero - Black	
A00420.T0	Titanio - Titanium	

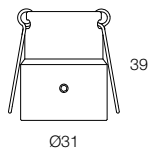

Code	Description	Use with:
A00293.40	Accessorio per montaggio con molle Spring mounting support	Lui page 51

Ø 33 mm



Lei
page 53



Filtro Ellittico
Linear Spread



Nido D'ape
Hex Louver



Filtro Prismatico
Prismatic Spread



Filtro Correttivo
Softening Lens

Code	Code	Code	Code	Use with:
A00416.30	A00417.30	A00418.30	A00419.30	Quantum P page 145
Grigio - Gray	Grigio - Gray	Grigio - Gray	Grigio - Gray	
A00416.40	A00417.40	A00418.40	A00419.40	
Nero - Black	Nero - Black	Nero - Black	Nero - Black	
A00416.T0	A00417.T0	A00418.T0	A00419.T0	
Titanio - Titanium	Titanio - Titanium	Titanio - Titanium	Titanio - Titanium	

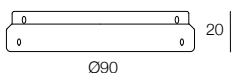



ACCESSORI BINARIO TRACK ACCESSORIES **230Vac**

Gli apparecchi a binario DGA rappresentano una reale alternativa alle più comuni sorgenti luminose finora impiegate per l'illuminazione generale di grandi ambienti.

Le nuove linee sfruttano la più evoluta tecnologia POWER LED, ottenendo prestazioni illuminotecniche elevatissime con bassi consumi energetici. I proiettori sono forniti con adattatore a binario Eurostandard che consente la loro installazione su binari a tre circuiti (i più diffusi sul mercato). Le soluzioni offerte sono adeguate per l'illuminazione di vari ambienti, come: negozi, ristoranti, bar, grandi magazzini, uffici, edifici pubblici, aeroporti o musei.

La struttura modulare del sistema a Binario permette di prolungarlo e adattarlo a qualsiasi necessità. La modularità del prodotto aiuta architetti e designers ad adattarlo nello spazio.

The fixtures track DGA series are the new alternatives to the common light sources that have been used up to now for general lighting of large spaces.

The new series exploit the most advanced POWER LED technology, achieving high lighting performances with very low energy consumption. The spotlights are provided with track adapter Eurostandard, which permits the installation on three-circuits lighting tracks (the most widespread on the market).

The fixtures propose suitable solutions for lighting many different spaces, like: shops, restaurants, department stores, offices, public buildings, museums and airports.

The modular structure of our track system makes it easy to extend and adapt to various needs. Modularity helps architects and designers to fit the system into the appropriate space.

BINARIO DA SUPERFICIE.

SURFACE MOUNTING TRACK.

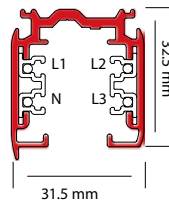
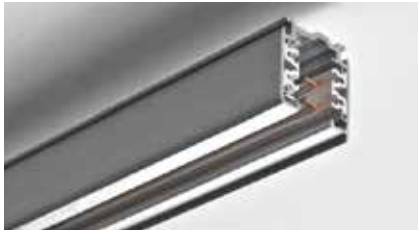

BINARIO DA INCASSO.

RECESSED TRACK.

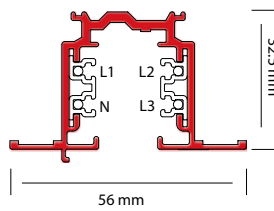
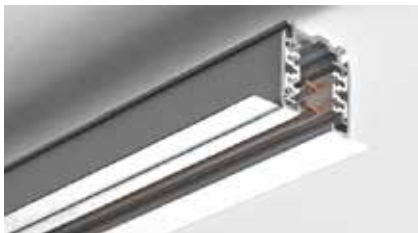

Uso degli accessori a "I" e a "T"
La linea rossa indica la linea della polarità.

Use of "L" and "T" accessories
Red line indicates polarity ridge.

Vista in pianta

Floor view

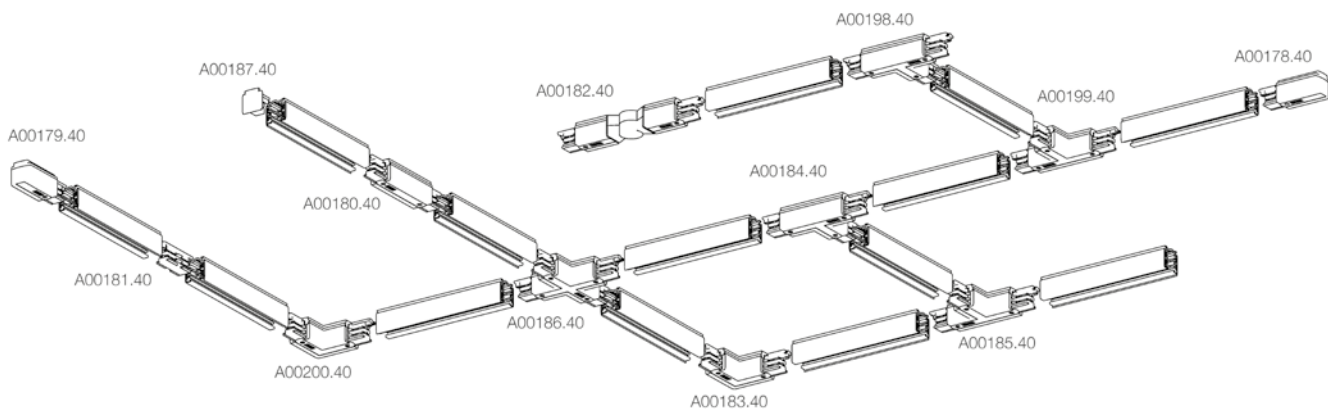
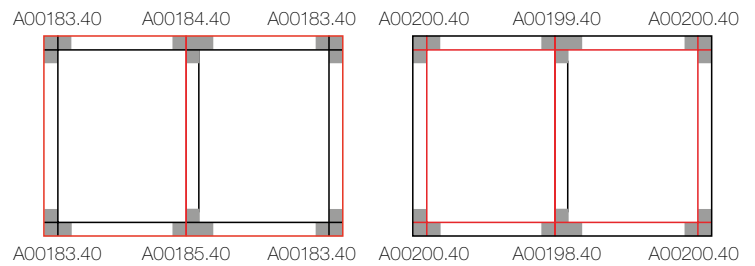
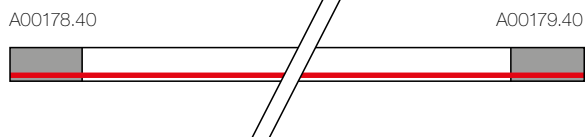



Code	Description
A00172._0	Binario da superficie L = 1 metro Surface mounting L =1 meters
A00173._0	Binario da superficie L = 2 metro Surface mounting L = 2 meters
A00174._0	Binario da superficie L = 3 metri Surface mounting L =3 meters

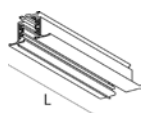

Code	Description
A00175._0	Binario da incasso L = 1 metro Recessed track L =1 meters
A00176._0	Binario da incasso L = 2 metro Recessed track L = 2 meters
A00177._0	Binario da incasso L = 3 metri Recessed track L =3 meters



Code	Description
A00182._0	Connettore orientabile per binario Adjustable feed for track



Code	Description
A00178._0	Connettore sinistro ingresso alimentazione Left input



Code	Description
A00179._0	Connettore destro ingresso alimentazione Right input



Code	Description
A00180._0	Connettore lineare ingresso alimentazione Middle input



Code	Description
A00183._0	Connettore a L ingresso alimentazione L input



Code	Description
A00200._0	Connettore a L ingresso alimentazione L input

FINISH

- 3 Grigio - Gray
- B Bianco - White
- N Nero - Black

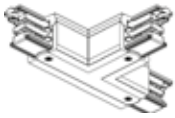

Code	Description
A00184_0	Connettore a T dx ingresso alimentazione T (right) input

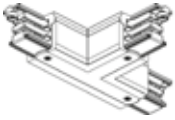

Code	Description
A00198_0	Connettore a T sx ingresso alimentazione T (left) input

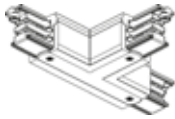

Code	Description
A00185_0	Connettore a T sx ingresso alimentazione T (left) input

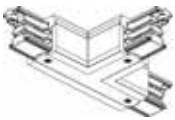

Code	Description
A00199_0	Connettore a T dx ingresso alimentazione T (right) input



Code	Description
A00186_0	Connettore a X ingresso alimentazione X input



Code	Description
A00181_0	Connettore lineare per binario Middle feed for track

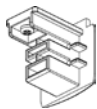

Code	Description
A00187_0	Elemento terminale di chiusura Closing plug

FINISH

FINISH

- 3 Grigio - Gray
- B Bianco - White
- N Nero - Black

ACCESSORI PER BINARIO A SOSPENSIONE

TRACK SUSPENSION PARTS



La distanza di fissaggio consigliata è di 1000mm.
 NOTA: Un carico non superiore a 10Kg di peso può essere attaccato ad un elemento essendo lo sforzo di rottura per trazione 100 N (1kg = 9,81N) e la coppia massima 2,5 Nm. (GA 69 5kg/50 N).

The recommended fastening distance is 1000mm.
 NOTE: A load not heavier than 10kg may hang on a power takeoff adapter, the pull strength being 100 N (1kp = 9.81N) and the maximum torque 2.5Nm. (GA 69 5kg/50 N).

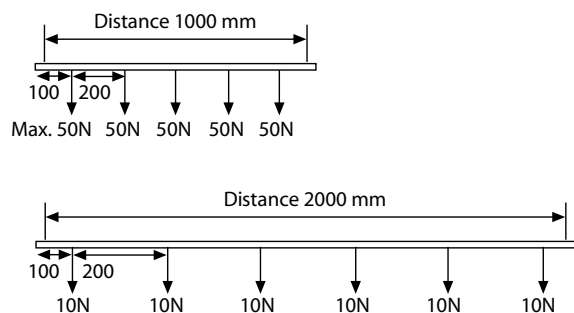

L/mm	a/mm	b/mm	c/mm	d/mm
1000	250	1000		
2000	250			
3000	250		1000	1000
4000	250		1500	1000

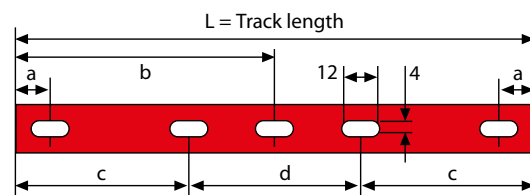

SOSPENSIONE RIGIDA

ROD SUSPENSION

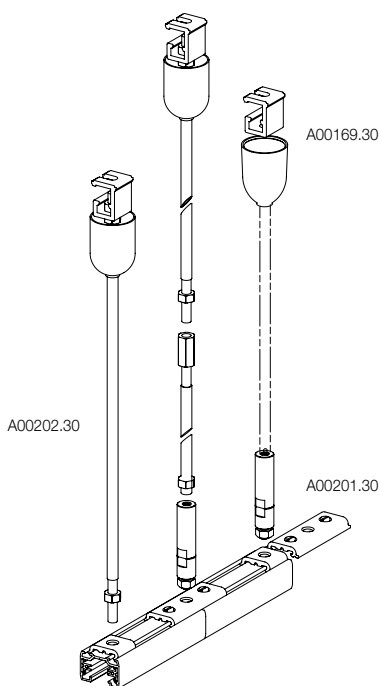

SOSPENSIONE CON CAVI

WIRE SUSPENSION

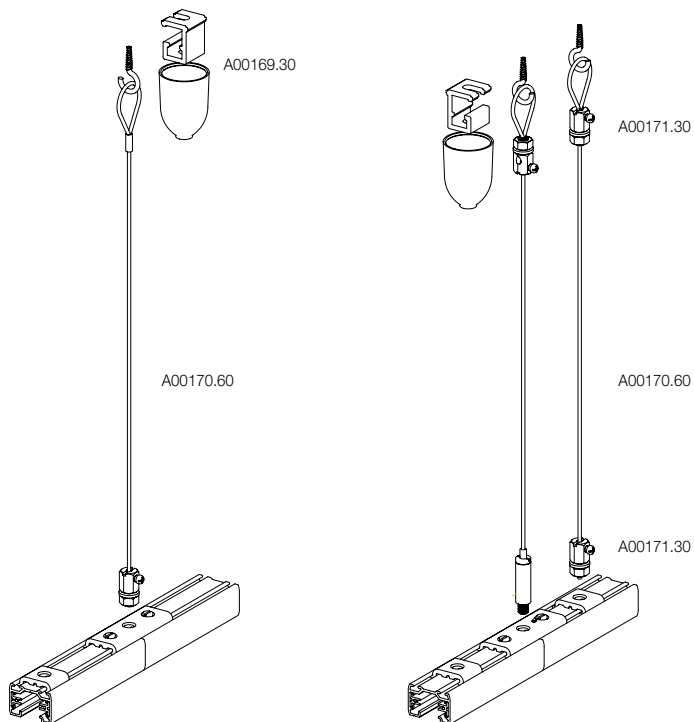

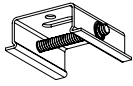

Code	Description
A00189.30	Elemento fissaggio per binario a sospensione Suspension clamp

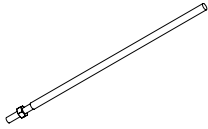

Code	Description
A00202.30	Astina filettata per sospensione Threaded arm for suspension mounting

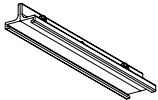

Code	Description
A00190.30	Elemento fissaggio per connessione binario Suspension clamp for track connection



Code	Description
A00201.30	Boccola fissaggio astina Bushing for fixing the arm

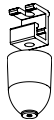

Code	Description
A00169...0	Accessorio fissaggio per binario a sospensione Ceiling clamp for suspension track

FINISH



Code	Description
A00170.60	Cavo per sospensione binario L =150 cm Suspension wire L =150 cm

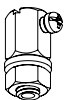

Code	Description
A00171.30	Boccola stringicavo per binario sospensione Height adjusting sleeve for suspension

FINISH

- 3 Grigio - Gray
- B Bianco - White
- N Nero - Black

DGA

DGA s.r.l.

Sede Legale E Amministrativa

Via Pietro Nenni 72/B
50013 Z.I. Capalle
Campi Bisenzio (FI) Italy
Tel./Ph. +39 055 8986235 r.a.
Fax +39 055 8986243
info@dga.it

www.dga.it



Unità Produttiva

Via Gattinella, 18
50013 Z.I. Capalle
Campi Bisenzio (FI) Italy
Tel./Ph. +39-055 5391520

Export Sales Department

export@dga.it
Tel. +39 055 8945892
Fax +39 055 8986243

Ufficio Vendite Italia

commerciale@dga.it
Tel. +39 055 8986235
Fax +39 055 8986243

Consulenza E Progettazione Illuminotecnica

Lighting Planning & Consulting

lighting@dga.it
Tel. +39 055 8986235
Fax +39 055 8986243

Assistenza Tecnica

ufficiotecnico@dga.it
Tel. +39 055 8986235
Fax +39 055 8986243