

betec[®]

Licht AG

Product Catalog

20



Dear Sir or Madam,

We would like to thank you very much for your interest
in our lighting product range.

The stated prices are recommended sales prices in euros
not including VAT.

If you have any questions about our products, delivery
times or custom-made items, please do not hesitate to
contact us.

Your customer no.: _____

Kind regards,

Your **betec** lighting-manufacturer

betec[®] Lighting AG
Felix-Wankel-Str. 10
85221 Dachau
Germany

Email: info@betec.de
Phone: +49(0)8131 292656
Fax: +49(0)8131 292651
Web: www.betec.de

Lighting Manufacturer

True to its company slogan – Light for the Future® – betec has enjoyed an excellent international reputation as an innovative lamp manufacturer for 40 years.

Its founder and chief designer Horst Lettenmayer, as chairman of the board, is leading the company together with his successor, Ms Julia-Alina Lettenmayer, as a board member, into a new age of lighting. The early and forward-looking decision not to follow the universal trend, but rather individual demands for design and technology was the basis for the success that continues to this day. The wide variety of different designer lamps, each dominating in its respective technological content, was obvious right from the first very product following the company's foundation. The "Clarus" painting lamp was a revolution in lighting in a minimalist guise. It is already a cult product and has received the German Art Protection award (Deutscher Kunstschutz) as well as prestigious international design awards.

Further developments focused on lighting for living spaces, offices and bathrooms, as well as light to showcase architecture. This resulted in lamps to brighten all these areas with "Light for the future®". Our efforts to carry on producing lamps as individual hand-crafted pieces, to take the customer's personal wishes into account and to use carefully selected materials runs counter to the current trend of quantity before quality.

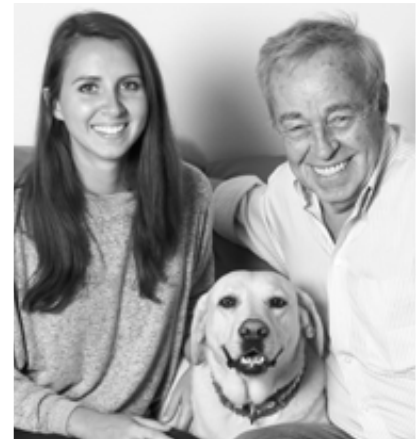

Julia-Alina und Horst Lettenmayer



Quality & Design

All of our lamp models' components are produced in our factory from brass using traditional armory metalworking. This is done with meticulous craftsmanship, from the selection of the raw materials to their processing right down to the surface treatment. To top it off, each component then receives its own colour treatment. Galvanic processes are carried out in a plant for medical instruments, and all varnishes are hand-varnished and baked at 180° C. A timeless design should also be timeless in its durability.

Brass poliert



Brass mat

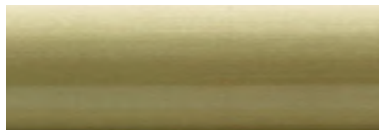

Black lackiert



24ct Gold poliert



24ct Gold mat

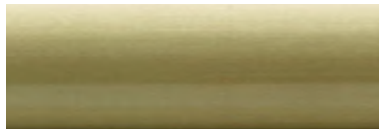

Nickel poliert



Chrome poliert

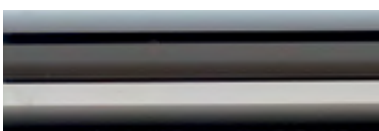

Nickel-mat

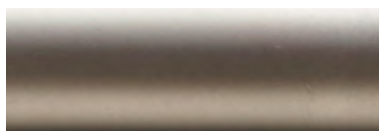

Brown



Other colors on request.



Article numbers

Coding principle:

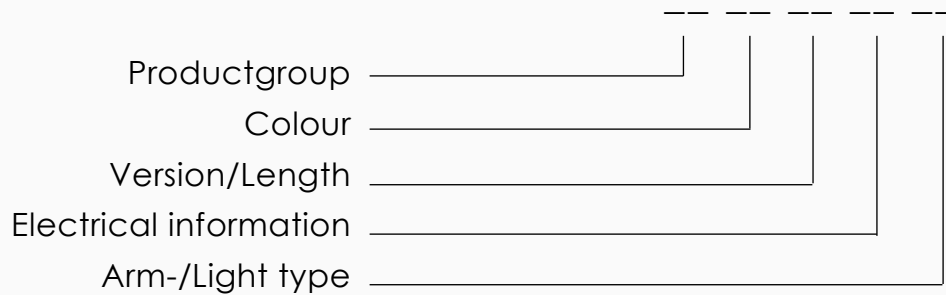

Product groups:

01 Clarus Picture lights 01 _ _ _ _ _

Colours:

Chrome polished	--	CO	--	--	--
Gold polished	--	GO	--	--	--
Brass polished	--	MO	--	--	--
Brass mat	--	MM	--	--	--
Nickel polished	--	NO	--	--	--
Nickel mat	--	NM	--	--	--
Brown	--	BO	--	--	--
Black mat	--	SM	--	--	--

Version/Length:

Length information _ _ _ 05 _ _ _

Light quantity & Light colour

LED Mono	--	--	--	M_	--	2400K Warm tone	--	--	--	_W	--
LED Duo	--	--	--	D_	--	2700K Neutral	--	--	--	_N	--
LED Trio	--	--	--	T_	--	3000K Daylight	--	--	--	_T	--
LED Power	--	--	--	P_	--	3100K Bright white	--	--	--	_H	--
						4000K Cold white	--	--	--	_K	--

Arm design/Light type:

Arms / Types _ _ _ _ _ 11

Index

	Picture lights
8 - 11	01 Clarus
12 - 15	04 Angulus
16 - 19	07 Minimus
20 - 21	07 Minimus Mono
22 - 23	17 Maximus
	Desk light
24 - 25	03 Ductus
	Music lighting
26 - 27	33 Piano
	Galerie-System
28 - 29	27 Galerie-Rail
	Table lamps
30 - 31	32 Noctis
32 - 33	11 Obelisk 1200
34 - 35	05 Acus Office
36 - 37	15 Dupplus
38 - 39	11 Centre où
40 - 41	26 Cappello
	Floor lamps
42 - 43	05 Acus
44 - 45	11 Obelisk 1900
46 - 47	10 Luxus

Index

	Page	Ceiling and wall lights
48 - 49		25 Filum
50 - 51		12 Hamus
52 - 53		30 Folium
54 - 55		09 Palus
56 - 57		28 Cubus
		Shelf lights
58 - 59		15 Steel tube shelf lamp
60 - 61		15 Vestiaire
62 - 63		15 Etagere
		Mirror lights
64 - 65		06 Magnus
66 - 67		06 Make up 1, 2, 3
68 - 69		06 Make up 5
70 - 71		06 Make up 6
72 - 73		06 Make up 7
74 - 75		06 Make up 8
76 - 77		06 Make up 10 Discus
78 - 79		06 Make up 11
		Pool spot
80 - 81		22 Disque
		Track systems
82 - 83		16 Planus
84 - 87		19 Galaxis-System
88 - 89		Clarus Conversion to LED
90 - 93		Special lights
94		Terms and conditions

01 Clarus

The latest advances in lighting technology right now are characterised by LED lamps. Our picture light is equipped with 3000 Kelvin as standard. The highly constant light output alongside low power consumption and an extremely long lifespan are ideal conditions for modern picture lighting. Application: lighting pictures, menus and music stands.

Material: brass, illuminant: single LED, LED efficiency class: A++, Ra: 90, ballast unit 20W:
107 x 41 x 22 mm, primary voltage: 220-240V, secondary voltage: DC 24V, rotatable fluorescent tube: Ø 14 mm, bracket tube: Ø 6 mm

Scope of delivery: whole lamp with illuminant, mounting set and a dimmable ballast unit.

IP20



Design: Horst Lettenmayer © betec

Colour	Article number
Brass polished	01 MO -- -- --
Brass mat	01 MM -- -- --
Chrome	01 CO -- -- --
Nickel polished	01 NO -- -- --
Nickel mat	01 NM -- -- --
Brown	01 BO -- -- --
Black mat	01 SM -- -- --
Gold 24ct polished	01 GO -- -- --
Gold 24ct mat	

Length	Colour	Light output	Article number
160 mm	Brass	0,5 Watt	01 MO 01 -- --
260 mm	Brass	1,5 Watt	01 MO 02 -- --
360 mm	Brass	2,5 Watt	01 MO 03 -- --
460 mm	Brass	3,5 Watt	01 MO 04 -- --
560 mm	Brass	4,5 Watt	01 MO 05 -- --
660 mm	Brass	5,5 Watt	01 MO 06 -- --
760 mm	Brass	6,5 Watt	01 MO 07 -- --
860 mm	Brass	7,5 Watt	01 MO 08 -- --
960 mm	Brass	8,5 Watt	01 MO 09 -- --
1060 mm	Brass	9,5 Watt	01 MO 10 -- --
1160 mm	Brass	10,5 Watt	01 MO 11 -- --

LED Mono + Light colour: -- -- -- **M** - --

2400K	Warm tone	RA 80+ / 750 Lm	01 -- -- MW --
2700K	Neutral	RA 90+ / 1640 Lm	01 -- -- MN --
3000K	Daylight	RA 90+ / 750 Lm	01 -- -- MT --
3100K	Bright white	RA 90+ / 1640 Lm	01 -- -- MH --



Arm Type

Width

Article number

Type **11**

110 mm

01 -- -- -- **11**

Type **17**

170 mm

01 -- -- -- **17**

Type **22**

220 mm

01 -- -- -- **22**

Coupling arm



11 cm

Type 11



17 cm

Type 17



22 cm

Type 22



For each type

Coupling arm

Special option touch dimmer

Article number



51TD06LD24





04 Angulus

A novelty in our range of lamps is the "Angulus" picture light. The angular shape of the light fits in more harmoniously with corresponding picture frames. As with all our picture lamps, the lighting profile can be rotated in order to have the optimal light level set. This lamp has a duo LED illuminant, which allowed the light output to be doubled. Particularly suitable as display lighting. Application: lighting pictures, menus and music stands.

Material: brass, illuminant: dual LED, LED efficiency class: A++, Ra: 90, ballast unit: 220-240V, secondary voltage: DC 24V, 12W ballast unit: 94 x 36 x 18 mm, 30W ballast unit: 133 x 46 x 24 mm rotatable fluorescent tube: 17 x 17 mm, bracket tube: Ø 8 mm

Scope of delivery: whole lamp with diffuser cover, mounting set and a dimmable ballast unit.

IP20



Design: Horst Lettenmayer © betec

Colour	Article number
Brass polished	04 MO -- -- --
Brass mat	04 MM -- -- --
Chrome	04 CO -- -- --
Nickel polished	04 NO -- -- --
Nickel mat	04 NM -- -- --
Brown	04 BO -- -- --
Black mat	04 SM -- -- --
Gold 24ct polished	04 GO -- -- --
Gold 24ct mat	04 GM -- -- --

Length	Colour	Light output	Article number
250 mm	Brass	4 Watt	04 MO 02 -- --
500 mm	Brass	9 Watt	04 MO 05 -- --
750 mm	Brass	14 Watt	04 MO 07 -- --
1000 mm	Brass	19 Watt	04 MO 10 -- --

LED Duo + Light colour: -- -- -- **D** - --

2400K	Warm tone	RA 80+ / 750 Lm	04 -- -- DW --
2700K	Neutral	RA 90+ / 1640 Lm	04 -- -- DN --
3000K	Daylight	RA 90+ / 750 Lm	04 -- -- DT --
3100K	Bright white	RA 90+ / 1640 Lm	04 -- -- DH --



Arm Type	Width	Article number
Type 15	150 mm	04 -- -- -- 15
Type 20	200 mm	04 -- -- -- 20
Type 25	250 mm	04 -- -- -- 25
Coupling arm		

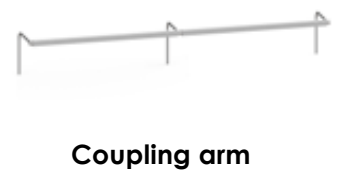
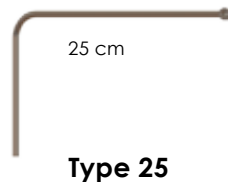
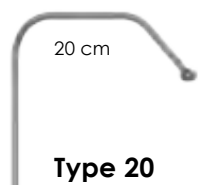

Special option touch dimmer	Article number
-----------------------------	----------------



54TD08LD24



07 Minimus

As an extension to our "Clarus" lamp, but with a tube diameter of 18 mm, this lamp was developed for the use of a dual LED unit. The double brightness of the "Minimus" is a decisive factor for choosing this product. As a secondary effect, this painting lamp can also be used to brighten rooms. The output light mainly brightens the object in question, but the inevitable scattered light emitted from the lamp fills the room with a basic level of brightness that is an unperceived requirement for our well-being. Application: picture lighting, menu lighting and music stand lighting.

Material: brass, illuminant: dual LED, LED efficiency class: A++, Ra: 90, ballast unit: 220-240V, secondary voltage: DC 24V, 12W ballast unit: 94 x 36 x 18 mm, 30W ballast unit: 133 x 46 x 24 mm, rotatable fluorescent tube: Ø 18 mm, bracket tube: Ø 8 mm

Scope of delivery: whole lamp with illuminant, mounting set and a dimmable ballast unit.

IP20



Design: Horst Lettenmayer © betec

Colour	Article number
Brass polished	07 MO -- -- --
Brass mat	07 MM -- -- --
Chrome	07 CO -- -- --
Nickel polished	07 NO -- -- --
Nickel mat	07 NM -- -- --
Brown	07 BO -- -- --
Black mat	07 SM -- -- --
Gold 24ct polished	07 GO -- -- --
Gold 24ct mat	07 GM -- -- --

Length	Colour	Light output	Article number
591 mm	Brass	10 Watt	07 MO 06 -- --
891 mm	Brass	16 Watt	07 MO 09 -- --
1191 mm	Brass	22 Watt	07 MO 12 -- --

LED Duo + Light colour:			-- -- -- D -- --
2400K	Warm tone	RA 80+ / 750 Lm	07 -- -- DW --
2700K	Neutral	RA 90+ / 1640 Lm	07 -- -- DN --
3000K	Daylight	RA 90+ / 750 Lm	07 -- -- DT --
3100K	Bright white	RA 90+ / 1640 Lm	07 -- -- DH --





07 Minimus Mono

The LED picture light with a single central bracket is ideal for small pictures or photos. The light output is very high despite its short length. The lamp can either be attached to the back of the picture frame or to the wall. The level of light can be regulated by parallel rotation of the ends of the tubes.

Material: brass, illuminant: single LED, LED efficiency class: A++, Ra: 90, ballast unit: 220-240V, secondary voltage: DC 24V, 12W ballast unit: 94 x 36 x 18 mm, light tube: Ø 18 mm, fluorescent tube: Ø 8 mm

Scope of delivery: whole lamp with LED illuminant, mounting set and a dimmable ballast unit.

IP20



Design: Horst Lettenmayer © betec

Colour	Article number
Brass polished	07 MO -- -- --
Brass mat	07 MM -- -- --
Chrome	07 CO -- -- --
Nickel polished	07 NO -- -- --
Nickel mat	07 NM -- -- --
Brown	07 BO -- -- --
Black mat	07 SM -- -- --
Gold 24ct polished	07 GO -- -- --
Gold 24ct mat	07 GM -- -- --

Length	Colour	Light output	Article number
140 mm	Brass	2 Watt, 116 lm	07 MO 01 -- --

LED Duo + Light colour:			-- -- -- M -- --
2400K	Warm tone	RA 80+ / 750 Lm	07 -- -- MW --
2700K	Neutral	RA 90+ / 1640 Lm	07 -- -- MN --
3000K	Daylight	RA 90+ / 750 Lm	07 -- -- MT --
3100K	Bright white	RA 90+ / 1640 Lm	07 -- -- MH --

Special option touch dimmer	Article number
-----------------------------	----------------



57TD08LD24



17 Maximus

In order to illuminate large paintings with strong frames, a correspondingly larger picture light is required to optically balance the picture and the light. This is why the „Maximus“ picture light was created, which can be used for pictures up to several metres wide. Using this lamp as painting or museum lighting also has a secondary effect of brightening the room. The output light mainly brightens the object in question, but the inevitable scattered light emitted from the lamp fills the room with a basic level of brightness that is an unperceived requirement for our well-being. Application: picture lighting, shelf lighting and wall lighting.

Material: brass, illuminant: dual LED, LED efficiency class: A++, Ra: 90, ballast unit: 220-240V, secondary voltage: DC 24V, rotatable fluorescent tube: Ø 34 mm, bracket tube: Ø 8 mm, ballast unit 12W: 94 x 36 x 18 mm, 30W ballast unit: 133 x 46 x 24 mm

Scope of delivery: whole lamp with illuminant, mounting set and a dimmable ballast unit.

IP20



Design: Horst Lettenmayer © betec

Colour	Article number
Brass polished	17 MO -- -- --
Brass mat	17 MM -- -- --
Chrome	17 CO -- -- --
Nickel polished	17 NO -- -- --
Nickel mat	17 NM -- -- --
Brown	17 BO -- -- --
Black mat	17 SM -- -- --
Gold 24ct polished	17 GO -- -- --
Gold 24ct mat	17 GM -- -- --

Length	Colour	Light output	Article number
490 mm	Brass	8 Watt	17 MO 05 -- --
650 mm	Brass	11 Watt	17 MO 06 -- --
770 mm	Brass	13 Watt	17 MO 07 -- --
950 mm	Brass	17 Watt	17 MO 09 -- --
1250 mm	Brass	23 Watt	17 MO 12 -- --
1550 mm	Brass	29 Watt	17 MO 15 -- --

LED Duo + Light colour:			-- -- -- D -- --
2400K	Warm tone	RA 80+ / 750 Lm	17 -- -- DW --
2700K	Neutral	RA 90+ / 1640 Lm	17 -- -- DN --
3000K	Daylight	RA 90+ / 750 Lm	17 -- -- DT --
3100K	Bright white	RA 90+ / 1640 Lm	17 -- -- DH --



Arm Type

Width

Article number

Type 20	200 mm	17 -- -- -- 20
Type 25	250 mm	17 -- -- -- 25
Type 30	300 mm	17 -- -- -- 30
Type 10	100 mm	17 -- -- -- 10
Coupling arm		

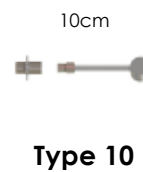
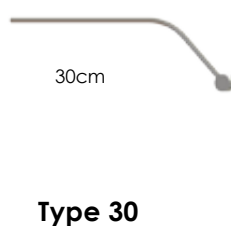
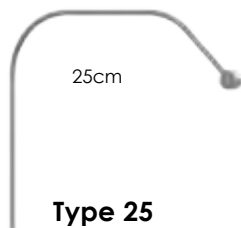
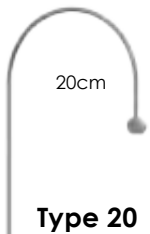

Special option touch dimmer

Article number



67TD08LD24

03 Ductus

Desk or wall lamp with the highest level of precision craftsmanship. Holding brackets come in various shapes and lengths. Either as a plug-in version on lecterns, with mounting collars for installation on walls or for permanent installation on shelves using retaining clamps. Also ideal as a showcase lamp and display panel lighting due to its low current consumption and extremely long service life. Application: picture, menu and desk/lectern lighting.

Material: brass, illuminant: LED, LED efficiency class: A++, Ra: 90, primary voltage: 220-240V, secondary voltage: DC 24V, 20W ballast unit: 107 x 41 x 22 mm, rotatable fluorescent tube: Ø 14 mm, bracket tube: Ø 6 mm

Scope of delivery: whole lamp with LED illuminant, dimmable ballast unit and threaded sleeve with flange.

IP20



Design: Horst Lettenmayer © betec

Colour	Article number
Brass polished	03 MO -- -- --
Brass mat	03 MM -- -- --
Chrome	03 CO -- -- --
Nickel polished	03 NO -- -- --
Nickel mat	03 NM -- -- --
Brown	03 BO -- -- --
Black mat	03 SM -- -- --
Gold 24ct polished	03 GO -- -- --
Gold 24ct mat	03 GM -- -- --

Length	Colour	Light output	Article number
160 mm	Brass	0,5 Watt	03 MO 01 -- --
260 mm	Brass	1,5 Watt	03 MO 02 -- --
360 mm	Brass	2,5 Watt	03 MO 03 -- --
460 mm	Brass	3,5 Watt	03 MO 04 -- --
560 mm	Brass	4,5 Watt	03 MO 05 -- --
660 mm	Brass	5,5 Watt	03 MO 06 -- --
760 mm	Brass	6,5 Watt	03 MO 07 -- --
860 mm	Brass	7,5 Watt	03 MO 08 -- --
960 mm	Brass	8,5 Watt	03 MO 09 -- --
1060 mm	Brass	9,5 Watt	03 MO 10 -- --
1160 mm	Brass	10,5 Watt	03 MO 11 -- --

LED Mono + Light colour: -- -- -- **M** -- --

2400K	Warm tone	RA 80+ / 750 Lm	03 -- -- MW --
2700K	Neutral	RA 90+ / 1640 Lm	03 -- -- MN --
3000K	Daylight	RA 90+ / 750 Lm	03 -- -- MT --
3100K	Bright white	RA 90+ / 1640 Lm	03 -- -- MH --



Arm Type

Width

Article number

Type **10**

100 mm

03 -- -- -- **10**

Type **18**

180 mm

03 -- -- -- **18**

Type **14**

140 mm

03 -- -- -- **14**

Type **04**

40 mm

03 -- -- -- **04**

Coupling arm

4cm



Type 04

10cm



Type 10

14,5cm



Type 14

17,5cm



Type 18

Special option touch dimmer

Article number



53TD00LD24

33 Piano

LED music stand lamp made of brass with black, flocked switchboard. Every pianist or organist needs good lighting to be able to read their music. This lamp solves the problem of attachment to valuable instruments. It is adjustable in height and attached to a velvet-covered board, which then becomes a music stand. The only wiring is a socket on the bass end of the keyboard. Simply unplug the transformer cable, and the board can be readily removed, together with the lamp, and the piano closed. The fluorescent tube can be rotated and the pianist can adjust the lighting him or herself. Application: music stand lighting, menu lighting.

Material: brass, illuminant: LED, LED efficiency class: A++, Ra: 90, ballast unit: 220-240V, secondary voltage: DC 24V/12W, panel dimensions: 380 x 250 x 12 mm, total weight: 900 g, rotatable fluorescent tube: Ø 14 mm, bracket tube: Ø 6 mm, bracket width: 190 mm

Scope of delivery: whole lamp with LED illuminant, touch dimmer, plug-in power supply (4-metre long cable) and optional black panel.

IP20



Design: Horst Lettenmayer © betec

Colour	Article number
Brass polished	33 MO -- -- --

Length	Colour	Light output	Article number
360 mm	Brass	2,5 Watt	33 MO 03 -- --

LED Mono + Light colour: -- -- -- **M** -- --

3000K Daylight RA 90+ / 750 Lm 33 -- -- **MT** --

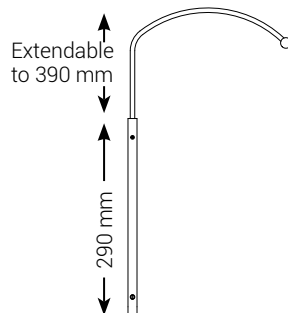
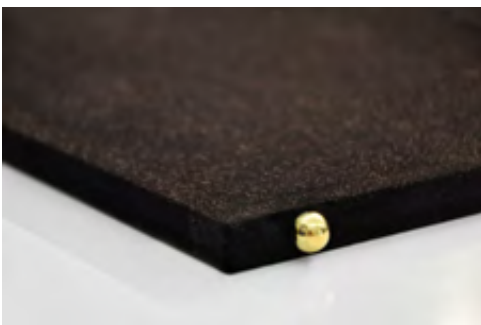



27 Galerie 2

Connected load for high-voltage lamps 110 – 230 V as well as for low-voltage operation (LED). Installed as a basic fitting all around rooms in the wall-ceiling joint, paintings can be hung at all heights and distances. At the same time, the electricity for a painting lamp is also conducted.

The suspension pendants made of 6-mm round aluminium are available in different lengths. By simply turning them 90°, they are locked in the busbar slot and supplied with electricity. The load of each pendant is 5 kg. For higher loads, several pendants should be used where necessary. A height-adjustable picture hook is mounted at the lower end of each pendant. With this equipment, you can custom decorate and illuminate each vernissage. Ideal for walls with wood panelling or fabric covering.

Material: aluminium, colour: white RAL9016, light output: 110-230 V, Ampere: 10, rail dimensions: 36 x 12 mm, coupling piece dimensions: 40 x 25 mm, pendant head dimensions: 35 x 10 mm

IP20



Design: Horst Lettenmayer © betec

Product	Colour	Length	Article number
Track	White	2000 mm	27GS36AS12

As an addition there are the following products:

Electric picture pendant with power supply and picture hook	White	1000 mm	27GP01OO10
	White	2000 mm	27GP02OO10
Coupling piece with Electricity feed	White	40 mm	27KS25PW40

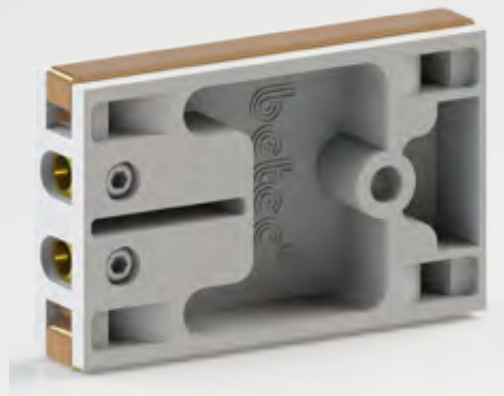

32 Noctis

As a light pedestal for accentuated room lighting or as an object spotlight for three-dimensional art. Contemporary lighting design lives and breathes on the contrast of light and dark. Optical focal points are thereby emphasised with light.

Material: brass, illuminant: power LED, LED efficiency class: A++, Ra: 90+, Kelvin: 3000K, base dimension: Ø 90 mm, total length: 660 mm

Scope of delivery: whole lamp with integrated ballast unit and touch dimmer.

IP20



Design: Horst Lettenmayer © betec

Length	Colour	Light output	Article number
360 mm	Brass	3,5 Watt / 172 Lm	32MO03PN00





11 Obelisk 1200

As a light pedestal for accentuated room lighting or as an objective spotlight for three-dimensional art. Contemporary lighting design lives and breathes on the contrast of light and dark. Optical focal points are thereby emphasised with light.

Material: brass, illuminant: dual LED, LED efficiency class: A++, Ra: 90+, Kelvin: 3000K, base dimensions: Ø 200 mm, total height: 1200 mm

Scope of delivery: whole lamp with integrated ballast unit and touch dimmer.

IP20



Design: Horst Lettenmayer © betec

Length	Colour	Light output	Article number
1200 mm	Brass	30 Watt / 1972 Lm	11MO12DT00
1200 mm	Chrome	30 Watt / 1972 Lm	11CO12DT00



05 Acus Office

A piece of minimised technology. Aesthetics in motion and workmanship. Clear relationships as to form and functionality. The lamp is attached to the table-top with an elaborately developed, patented clamping foot. The light stand can be raised or lowered as desired. The fluorescent tube's inclination is fully adjustable from a horizontal to a vertical position. In addition, the fluorescent tube, and therefore the light output can be rotated by 140°.

All electronic components as well as the switch are located as a ballast inside the thickened fluorescent tube. The wiring is 2.5 metres in length. Two rocker arms on the lamp make assembly tools unnecessary. The elegant, handmade lamp is destined to be a classic.

Material: brass, illuminant: dual LED, LED efficiency class: A++, Ra: 94+, Kelvin: 3100K, rotatable fluorescent tube: Ø 18 mm, lamp length: 1300 mm, height adjustability: up to max. 800 mm, plate thickness: up to max. 35 mm

Scope of delivery: whole lamp with illuminant and plug-in power supply.

IP20



Design: Horst Lettenmayer © betec

Length	Colour	Light output	Article number
1300 mm	Chrome	18 Watt	05CO 13 DH18





14 Dupplus

An unusual table lamp. The light, which is emitted lengthwise, can be adjusted by turning the fluorescent tubes as desired. Application: lighting objects such as collections and decorations.

Material: brass, illuminant: single LED, LED lifespan: 50,000 hours, light colour: 3000K, Ra: 90+, LED efficiency class: A++, primary voltage: 220V - 240V, rotatable fluorescent tube: Ø 14 mm, total height: 470 mm, base dimensions: 85 x 85 x 10 mm

Scope of delivery: whole lamp with illuminant, touch dimmer and plug-in power supply.

IP20



Design: Horst Lettenmayer © betec

Höhe	Colour	Light output	Article number
470 mm	Chrome	7 Watt	14CO04MT07



11 Centre oú

Art needs to be positioned well in a room to be effective. At the same time, the art requires special lighting. The purpose of this source of light is to place the work of art centrally for the viewer. Art does not follow light, but rather light follows art. Sculptures or pictures shape the room with their structure, colour and relief. Their effect is emphasised with this light effigy – from a warmly dimmed glow to bright white floodlights. Harmony of art and light to perfection. The brightness can be adjusted via a dimmer control.

Material: brass, illuminant: dual LED, lifespan: 50,000 hours, efficiency class: A++, light colour: 3100K, Ra: 94+, primary voltage: 220V - 240V, primary voltage: 220V - 240V, dimmable: via touch dimmer, rotatable fluorescent tube: Ø 18 mm, total height: 950 mm, base dimensions: 100 x 100 x 50 mm

Scope of delivery: whole lamp with illuminant and power supply.

IP20



Design: Dr. Thomas Schrade & Horst Lettenmayer © betec

Length	Colour	Light output	Article number
950 mm	Nickel polished	15 Watt	11NO09DT15





26 Cappello

The LED era makes it possible to design unconventional lighting. With this lamp, the light is no longer centre stage, but the lampshade itself is the light. Power is supplied via a 2.5 m cable power pack and a miniature jack plug directly in the lampshade, and is switched on and off using a cable switch. If you wish to greet your host with the obligatory champagne bottle in your hand for your next invitation, simply put this lampshade over the bottleneck.

Material: brass, illuminant: LED, lifespan: 50,000 hours, efficiency class: A++, light colour: 2700K, Ra: 94+, primary voltage: 100V - 240V

Scope of delivery: lampshade with LED illuminant and plug-in power supply with rocker switch.

IP20



Design: Horst Lettenmayer © betec

Length	Colour	Light output	Article number
250 mm	Red	7,5 Watt / 517 Lm	26RT25MN30
250 mm	Black	7,5 Watt / 517 Lm	26SO20MN30





05 Acus

Wherever illumination is desired in a room in vertical or horizontal form, this modern light needle expresses innovative elegance. Application: office, object, shop window, or stand lighting lamp for modern sculptures and large paintings.

Material: brass, illuminant: power LED, lifespan: 50,000 hours, efficiency class: A++, light colour: 3000K, Ra: 90+, primary voltage: 220V - 240V, fluorescent tube: Ø 16 mm, base plate: Ø 294 mm, height: 2150 mm

Scope of delivery: whole lamp with illuminant, touch dimmer and plug-in power supply.

IP20



Design: Horst Lettenmayer © betec

Length	Colour	Light output	Article number
2150 mm	Chrome polished	17,5 Watt	05CO21MT17



11 Obelisk 1900

Light can significantly support the emphasis on focal points in a room. With this graceful light column, walls can be brightened, or silhouettes created, in a targeted manner. All the power components are housed in the lamp's conical base. Application: office, object, shop window, and stand lighting lamp for modern sculptures and large paintings.

Material: brass, illuminant: dual LED, lifespan: 50,000 hours, efficiency class: A++, light colour: 3000K, Ra: 90+, primary voltage: 220V - 240V, fluorescent tube: Ø 34 mm, base plate: Ø 294 mm, height: 1900 mm

Scope of delivery: whole lamp with illuminant, touch dimmer and plug-in power supply.

IP20



Design: Horst Lettenmayer © betec

Length	Colour	Light output	Article number
1900 mm	Chrome polished	29 Watt	11CO19DT00
1900 mm	Nickel mat	29 Watt	11NM19DT00



10 LUXUS

Bright, glare-free table lamp in an „Art Deco“ style as a high-quality, hand-made designer lamp. The lamp head can be rotated up to 360° and distributes the light on tables, walls or ceilings in a pleasant way. The „Luxus“ table lamp is equipped with 7 power LEDs and is technologically very modern with a retro look.

Material: brass, illuminant: dual LED, lifespan: 50,000 hours, efficiency class: A++, light colour: 3000K, Ra: 90+, primary voltage: 220V - 240V, colour rendering index: 90, dimmable: via touch dimmer, base dimensions: 200 x 200 x 20 mm

Scope of delivery: whole lamp with illuminant, plug-in power supply and touch point.

IP20



Design: Horst Lettenmayer © betec

Length	Colour	Watt	Article number
650 mm	Nickel polished	21 Watt	10NO03PT01
650 mm	Brass polished	21 Watt	10MO03PT01
1270 mm	Nickel polished	21 Watt	10NO04PT01
1270 mm	Brass polished	21 Watt	10NO04PT01
1850 mm	Nickel polished	21 Watt	10NO05PT01
1850 mm	Brass polished	21 Watt	10MO05PT01



25 Filum

Height-adjustable pendant lighting fixture with touch dimmer and switching technology. Fluorescent tube can be rotated 360° for targeted lighting. The switching and stepless dimming functions are executed by touching the pin in the fluorescent tube. The pendant lamp is suitable for all ceiling heights, since the cable lengths can be individually adjusted. The fluorescent tube is made of brass and then plated in shiny chrome. The geometric counterweight is made of black plastic.

Material: brass, illuminant: dual LED, LED lifespan: 50,000 hours, efficiency class: A++, light colour: 3000K, Ra: 90+, dimmable: touch dimmer, primary voltage: 220V - 240V, secondary voltage: DC 24V, ECG ceiling fixture: 75 x 70 mm, rotatable fluorescent tube: Ø 18 mm

Scope of delivery: complete luminaire with ceiling mount including electronic LED ballast unit in the ceiling fixture and touch dimmer on the fluorescent tube. Pendant cords as standard for a ceiling height of 3.10 metres.

IP20



Design: Horst Lettenmayer © betec

Length	Colour	Light output	Article number
891 mm	Chrome	16 Watt	25CO 09 DT16
1191 mm	polished	22 Watt	25CO 12 DT22
1491 mm	Chrome	28 Watt	25CO 15 DT28



12 Hamus

Wall and ceiling light with an aesthetic plastic housing (polycarbonate). Rotatable, with one or two arms and a 4-watt LED spot. Application: whether as a picture light or as a ceiling spot, this variable, complete lamp fulfils all requirements. The plastic cylinder can be fixed into drywall ceilings.

Material: polycarbonate & brass, illuminant: LED, illuminant base: GX 5.3, efficiency class: A++, secondary voltage: DC 12V, primary voltage: 220 - 240V, 12W ballast unit: Ø 55 x 23 mm

Scope of delivery: whole lamp with integrated ballast unit without LED lamp.

IP20



Design: Horst Lettenmayer © betec

Length	Colour	Article number
Hamus 1	White / Nickel	12WN 01 MN01
Hamus 1	Black / Nickel	12SN 01 MN01
Hamus 2	White / Nickel	12WN 02 MN01
Hamus 2	Black / Nickel	12SN 02 MN01

As an addition there are the following products:

LED Leuchtmittel	2700 K / 4W / 12V / 30°	88LD04OO30
Spot Halterung	White	62 WO 01LO00
Spot Halterung	Black	62 SO 01LO00

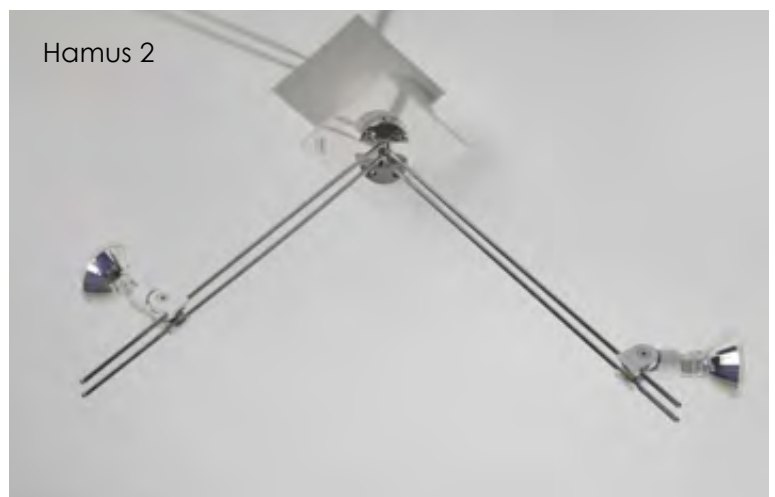
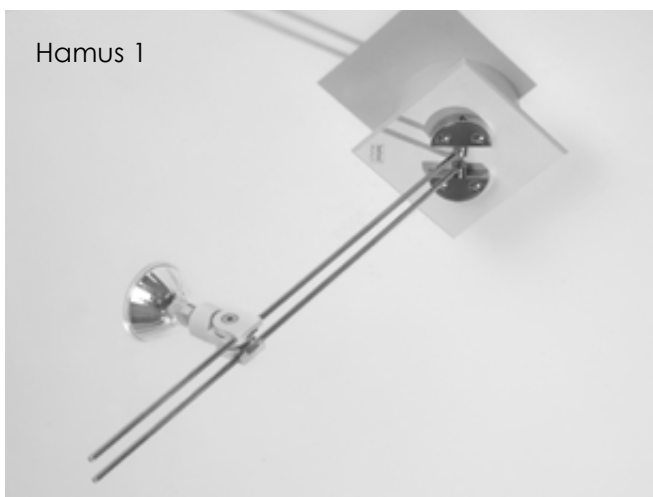



30 Folium

Classic wall lights brighten things up. This lamp's decor takes you on the path of your dreams. As a lamp manufacturer, we not only take care of lighting, but also want to create an atmosphere in which you feel good. Spend your next holidays at home.

Material: powder-coated aluminium, illuminant: power LED, lifespan: 50,000 hours, efficiency class: A++, light colour: 3000K, Ra: 90+, dimensions: 1900 x 180 mm

Scope of delivery: whole lamp with wall bracket and plug-in power supply.

IP20



Design: Horst Lettenmayer © betec

Length	Colour	Light output	Article number
1900 mm	Green/Gold	18 Watt	30GG19PT00



09 Palus

Decorative wall lamp with integrated transformer for two light sources. The technical details are excellently supported by the exciting design. A wall and ceiling spotlight that reflects drawings of light as symmetrical patterns on walls and simultaneously covers floor and ceiling. Application: can also be used as a directional aid in offices and public buildings. In cinemas, museums, foyers, private entrances and clinics as wall brighteners, and to give bistros and cafés a better ambience.

Material: painted aluminium, illuminant: LED 2 x 4W, illuminant base: GX 5.3, efficiency class: A++, secondary voltage: DC 12V, primary voltage: 220 - 240V, 12W ballast unit: integrated.

Scope of delivery: whole lamp with 2 LED lamps and wall bracket.

IP20



Design: Horst Lettenmayer © betec

Length	Colour	Light output	Article number
400 mm	White	8 Watt	09 WO 02DN02
400 mm	Red	8 Watt	09 RO 02DN02
400 mm	Silver	8 Watt	09 AO 02DN02

The following product is available as illuminant:

Spot	2700 K	4W / 12V / 30°	88LD04OO30
------	--------	----------------	------------

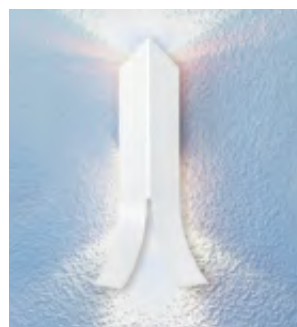



28 Cubus

Stylish linear fluorescent LED lamp designed as a modern chandelier in aluminium. Dual strip lights with a 2400 or 3000 Kelvin light colour are located within the U-beams. This way, the core brightness is distributed over a large volume of space without glare. Its unobtrusive design provides harmonisation in both classic arcades as well as modern halls and archways. The light output is 88 watts and can be dimmed steplessly. The acrylic-covered strip lights make this lamp last up to 50,000 hours without maintenance. The length of the suspension pendant can be supplied as per the customer's wishes.

Material: aluminium, illuminant: dual LED, lifespan: 50,000 hours, efficiency class: A++, light colour: 2700K, Ra: 94+, ceiling plate: 40 x 40 mm, suspension pendant: Ø 18 x 1200 mm, chandelier dimensions: 1200 x 400 mm, 100W ballast unit: 30 x 51 x 40 mm

Scope of delivery: whole lamp with built-in LED illuminant, plexiglass cover.

IP20



Design: Gottfried Riesner © betec

Length	Colour	Light output	Article number
1200 mm	Brown	88 Watt	28BO12DN04



15 Shelf light

As part of the new development of LEDs for lamps and lighting systems, we have developed a shelf lamp with an integrated LED illuminant. Since LEDs offer only advantages when it comes to energy balance, safety requirements and temperature management, this lamp is compatible for use with tubular steel shelves such as USM Haller systems or others. System lengths of 350 mm and 625 mm on request.

Material: brass, illuminant: LED, lifespan: 50,000 hours, efficiency class: A++, light colour: 3000K, Ra: 90+, primary voltage: 220V - 240V, secondary voltage: DC 24V, tube dimensions: Ø 19.3 mm

Scope of delivery: fluorescent tube, including LED illuminant, 2 x drilled connectors, 2 metres of wiring (other cable lengths possible on request), suitable ballast unit. Feed wire for assembly.

IP20



Design: Horst Lettenmayer © betec

Length	Colour	Light output	Article number
500 mm	Chrome polished	3 Watt	15CO05MT00

As an addition there are the following products:	Article number
Connector drilled (hollow screw)	15ST08OO39

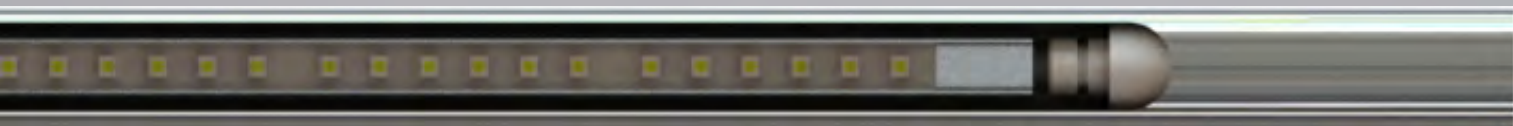

15 Etagere

Shelf lamp for retrofitting. An aluminium angle profile is equipped with a continuous LED strip and a transparent cover. Lamps can also be delivered according to the measurements you need.

Material: aluminium, illuminant: dual LED, lifespan: 50,000 hours, efficiency class: A++, light colour: 2700K, Ra: 94+, primary voltage: 220V - 240V, secondary voltage: DC 24V, profile dimensions: 18 x 18 mm

Scope of delivery: whole lamp with cover and plug-in power supply.

IP20



Design: Horst Lettenmayer © betec

Length	Colour	Light output	Article number
560 mm	Silver Anodized	11 Watt	15AS05DN00
1000 mm	Silver Anodized	19 Watt	15AS10DN00



15 Vestiaire

The classic wardrobe rail has now turned into wardrobe lighting. High-quality brass tube with two decorative rings enclosed by a continuous LED light strip with a 3000 Kelvin light colour. This lighting makes the often tedious choice of what to wear easier. If the wardrobe doors are closed, the light will then automatically switch on when the doors are opened. On request, the lamp can also be delivered according to the dimensions you need.

Material: brass, illuminant: single LED, lifespan: 50,000 hours, efficiency class: A++, light colour: 3000K, Ra: 90+, primary voltage: 220V - 240V, secondary voltage: DC 24V, tube dimensions: Ø 34 mm

Scope of delivery: whole lamp with two decorative rings and mounting blocks as well as ballast unit. (Cabinet switch will be charged extra)

IP20



Design: Horst Lettenmayer © betec

Length	Colour	Light output	Article number
500 mm	Brass polished	9,5 Watt	15MO05MT00
500 mm	Chrome polished	9,5 Watt	15CO05MT00
750 mm	Brass polished	14 Watt	15MO07MT00
750 mm	Chrome polished	14 Watt	15CO07MT00

As an addition there are the following product:

Door pressure switch

65DS00LD00





29 Magnus

High-quality 6mm crystal mirror with indirect circular LED illumination. Light can be controlled steplessly with a dimmer switch. The high-quality production takes place in our lamp factory. Highly decorative room element. Optimal in the beauty area as a make-up mirror, or in theatres or hotel areas.

Material: brass, illuminant: dual LED, lifespan: 50,000 hours, efficiency class: A++, light colour: 3000K, Ra: 90+, mirror shell: Ø 110 cm, mirror: Ø 90 cm

Scope of delivery: complete mirror with illuminant, touch dimmer, ballast unit and wall mount.

IP20



Design: Formstelle ©

Product	Colour	Light output	Article number
Magnus	Brass polished	86 Watt	29MO11DT00
Magnus	Brass mat	86 Watt	29MM11DT00



Photo: Formstelle München



06 Make up 2

The illuminated make-up mirror lends every room an exclusive elegance. In addition to the modern design, the warm light of the LED illuminant also provides optimal lighting. These mirror lights frame your reflection with light. Whether you angle the pivotable light to reflect off the mirror or to face you for direct illumination is up to you. These lights are plug-in, so they are easy to access for servicing at any time.

Material: brass, illuminant: single LED, lifespan: 50,000 hours, efficiency class: A++, primary voltage: 220V - 240V, secondary voltage: DC 24V, 12 W ballast unit: 94 x 36 x 18 mm, 30W ballast unit: 133 x 46 x 24 mm, rotatable fluorescent tube: Ø 14 mm, borehole: Ø 18 mm

Scope of delivery: whole lamp with illuminant and ballast unit without mirror.

IP20



Design: Horst Lettenmayer © betec

Product	Colour	Light output	Article number
Make up 2	Nickel polished	16 Watt	06NO02MN 02

LED-Light colour: -- -- -- **M** --

2400K	Warm tone	RA 80+ / 750 Lm	06 -- -- MW --
2700K	Neutral	RA 90+ / 1640 Lm	06 -- -- MN --
3000K	Daylight	RA 90+ / 750 Lm	06 -- -- MT --

Colour	Article number
Brass polished	06 MO -- -- --
Chrome	06 CO -- -- --
Nickel polished	06 NO -- -- --
Nickel mat	06 NM -- -- --

Special option	Article number
Touch-Dimmer 	56TD00LD24



06 Make up 5

Plug-in attachment light in a 24mm-diameter frosted glass tube. Creates optimal light distribution in the mirror, in the room and on the viewer. A flattering, first-class make-up lamp. With a patented LED illuminant. This mirror was developed as a make-up mirror for TV makeup artists. This geometry of the light is supported by the 3-strip LED tube, developed by us, with a beam angle of 3 x 130 degrees. These lights are plug-in, so they are easy to access for servicing at any time.

Material: brass, illuminant: single LED, lifespan: 50,000 hours, efficiency class: A++, primary voltage: 220V - 240V, secondary voltage: DC 24V, fluorescent tube: Ø 24 mm, glass tube: matted glass

Scope of delivery: whole lamp with LED illuminant and dimmable ballast unit without mirror.

IP20



Design: Horst Lettenmayer © betec

Colour	Article number
Brass polished	06 MO -- -- --
Chrome	06 CO -- -- --
Nickel polished	06 NO -- -- --
Nickel mat	06 NM -- -- --

Length	Colour	Light output	Article number
581 mm	Nickel polished	15 Watt	06NO 06 TT05
881 mm	Nickel polished	24 Watt	06NO 09 TT05

LED Trio + Light colour:			-- -- -- T --
2400K	Warm tone	RA 80+ / 750 Lm	06 -- -- TW --
2700K	Neutral	RA 90+ / 1640 Lm	06 -- -- TN --
3000K	Daylight	RA 90+ / 750 Lm	06 -- -- TT --
3100K	Bright white	RA 90+ / 1640 Lm	06 -- -- TH --

Special option touch dimmer	Article number
-----------------------------	----------------



56TD00LD24



06 Make up 6

Inspired by the „Art Deco“ era, this form shows classical modesty and cool aloofness. Here, too, you can choose the colour combination you want for the white frosted glass tube and metallic accessory. Double-light fixture, mounted in the mirror. A flattering, first-class make-up lamp. The rotatable LED tubes achieve optimal lighting due to their distance from the mirror. This mirror was developed as a make-up mirror for TV make-up artists. These lamps are plug-in, so they can be accessed for servicing at any time.

Material: brass, illuminant: triple LED, LED lifespan: 50,000 hours, LED efficiency class: A++, primary voltage: 220V - 240V, secondary voltage: DC 24V, fluorescent tube: Ø 34 mm, glass tube: matted glass

Scope of delivery: whole lamp with LED illuminant and dimmable ballast unit.

IP20



Design: Horst Lettenmayer © betec

Colour

Article number

Brass polished

06 **MO** -- -- --

Chrome

06 **CO** -- -- --

Nickel polished

06 **NO** -- -- --

Nickel mat

06 **NM** -- -- --

Length

Colour

Light output

Article number

581 mm

Nickel polished

15 Watt

06NO**06**TT06

881 mm

Nickel polished

24 Watt

06NO**09**TT06

LED Trio + Light colour:

-- -- -- **T** --

2400K

Warm tone

RA 80+ / 750 Lm

06 -- -- **TW** --

2700K

Neutral

RA 90+ / 1640 Lm

06 -- -- **TN** --

3000K

Daylight

RA 90+ / 750 Lm

06 -- -- **TT** --

3100K

Bright white

RA 90+ / 1640 Lm

06 -- -- **TH** --

Special option touch dimmer

Article number



56TD00LD24



06 Make up 7

Optimal mirror lamp that provides simultaneous room lighting in a classic design. Ideally suited for economical room lighting in guest toilets. The lamp can be mounted either on the wall or on the back of the mirror.

Material: brass, illuminant: triple LED, LED lifespan: 50,000 hours, LED efficiency class: A++, primary voltage: 220V - 240V, secondary voltage: DC 24V, fluorescent tube: Ø 34 mm, glass tube: matted glass

Scope of delivery: whole lamp with LED illuminant, assembly set and dimmable ballast unit.

IP20



Design: Horst Lettenmayer © betec

Colour

Article number

Brass polished

06 **MO** -- -- --

Chrome

06 **CO** -- -- --

Nickel polished

06 **NO** -- -- --

Nickel mat

06 **NM** -- -- --

Length

Colour

Light output

Article number

581 mm

Nickel polished

15 Watt

06NO**06**TT07

881 mm

Nickel polished

24 Watt

06NO**09**TT07

LED Trio + Light colour:

-- -- -- **T** --

2400K

Warm tone

RA 80+ / 750 Lm

06 -- -- **TW** --

2700K

Neutral

RA 90+ / 1640 Lm

06 -- -- **TN** --

3000K

Daylight

RA 90+ / 750 Lm

06 -- -- **TT** --

3100K

Bright white

RA 90+ / 1640 Lm

06 -- -- **TH** --

Special option touch dimmer

Article number



56TD00LD24



06 Make up 8

Extremely minimalistic and yet supremely functional. Assembled as one line of light, this lamp brightens entire rooms. Because the light shines both directly and indirectly into the room, there is no need for additional room lighting. The LED version can be rotated so that the brightness level between direct and indirect lighting can be changed. Application: bathrooms, dressing rooms in private areas, as well as in hotels.

Material: brass, illuminant: triple LED, lifespan: 50,000 hours, efficiency class: A++, primary voltage: 220V - 240V, secondary voltage: DC 24V, fluorescent tube: Ø 18 mm, glass tube: matted glass

Scope of delivery: whole lamp with LED illuminant and dimmable ballast unit.

IP20



Design: Horst Lettenmayer © betec

Colour	Article number
Brass polished	06 MO -- -- --
Chrome	06 CO -- -- --
Nickel polished	06 NO -- -- --
Nickel mat	06 NM -- -- --

Length	Colour	Light output	Article number
586 mm	Nickel polished	15 Watt	06NO 06 TT08
886 mm	Nickel polished	24 Watt	06NO 09 TT08
1186 mm	Nickel polished	33 Watt	06NO 12 TT08

LED Trio + Light colour:			-- -- -- T --
2400K	Warm tone	RA 80+ / 750 Lm	06 -- -- TW --
2700K	Neutral	RA 90+ / 1640 Lm	06 -- -- TN --
3000K	Daylight	RA 90+ / 750 Lm	06 -- -- TT --
3100K	Bright white	RA 90+ / 1640 Lm	06 -- -- TH --

Special option touch dimmer	Article number
-----------------------------	----------------



56TD00LD24



06 Discus

High-quality crystal mirror with indirect circular illumination with 56 LED modules connected in series. This design has an extravagant feel. The LED ring light will envelop your face in a flattering but honest manner. A prominent shape highlights your prominent features. It is only natural then that this mirror does not tolerate anything in its reflection apart from what it is supposed to show. The light illuminates the person facing it either as a standing version or as a wall mirror. The lamp can be regulated steplessly with a dimmer switch and ballast unit. Application: as a make-up mirror in bathrooms, theatres or hotels.

Material: brass, illuminant: LED, lifespan: 50,000 hours, LED efficiency class: A++, primary voltage: 220 - 240V, mirror circumference: Ø 520 mm, height of the stand: 340 mm, total height: 860 mm

Scope of delivery: whole mirror with illuminant, touch dimmer and ballast unit.

IP20



Design: Horst Lettenmayer © betec

Type	Colour	Light output	Article number
Stand version	Chrome polished	28 Watt	06CO10MT02
Wall version	Chrome polished	28 Watt	06CO10MT04

LED Mono + Light colour:

-- -- -- **M** --

2400K	Warm tone	RA 80+ / 750 Lm	06 -- -- MW --
2700K	Neutral	RA 90+ / 1640 Lm	06 -- -- MN --
3000K	Daylight	RA 90+ / 750 Lm	06 -- -- MT --
3100K	Bright white	RA 90+ / 1640 Lm	06 -- -- MH --

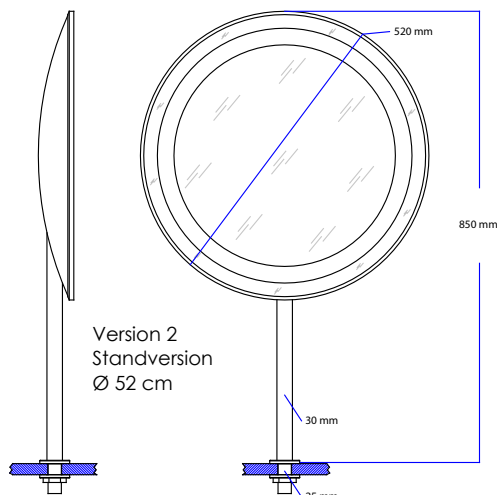



06 Make up 11

Energy-saving LED technology with warm tones ensures pleasant and effective bathroom lighting. The lamp can be attached to any mirror with a max. thickness of 6 mm. Place the mirror lamp profile with the hollow edge on the mirror and tighten onto the mirror rear with the 6 mm screws. Also ideally suited as under-cabinet lighting or counter lighting. Application: bathrooms, dressing rooms in private areas, and in hotels.

Material: aluminium, illuminant: dual LED, lifespan: 50.000 hours, efficiency class: A ++, primary voltage: 220V - 240V, secondary voltage: DC 24V, profile dimensions: 25 x 18 mm, 30W ballast unit: 133 x 46 x 24 mm

Scope of delivery: whole lamp with dual LED lighting, diffuser cover and dimmable ballast unit.

IP20



Design: Horst Lettenmayer © betec

Length	Colour	Light output	Article number
560 mm	Silver anodized	11 Watt	06AS 06 DN11
900 mm	Silver anodized	17 Watt	06AS 09 DN11
1000 mm	Silver anodized	19 Watt	06AS 10 DN11
	Silver anodized		06AS 00 DN11

LED Duo + Light colour:

-- -- -- **D** --

2400K	Warm tone	RA 80+ / 750 Lm	06 -- -- DW --
2700K	Neutral	RA 90+ / 1640 Lm	06 -- -- DN --
3000K	Daylight	RA 90+ / 750 Lm	06 -- -- DT --
3100K	Bright white	RA 90+ / 1640 Lm	06 -- -- DH --





22 Disque

Swimming pool flood light of high-quality workmanship with powerful LED light output. Energy-saving pool lighting. Installation height 16 mm on each swimming pool wall. Retrofitting is also possible and easy to carry out. Cooling is via colour convection. At 26° C, the LED lamp can be progressively dimmed (PWM ballast unit).

betec swimming pool flood lights can be retrofitted in existing swimming pools. Only 1/10 energy consumption. Very long service life. Minimal installation costs. Because the lamps generate less heat when used underwater, there is no algae growth on the surface. Flood light with complete V4A design. LSG safety glass and safety shutdown when cooling is interrupted (e.g., no water in the pool).

Material: stainless, polished, anti-algae V4A, diameter: Ø 185 mm, depth: 16 mm, illuminant: 6 x power LED, LED lifespan: 50,000 hours, LED efficiency class: A++, light colour: 3000 Kelvin, colour rendering index: 80, total: 2500 mA, light field: 700 x 850 mm, angle of light: 130°, range: 8m 50%

Scope of delivery: one flood light with encapsulated power LEDs and plug-in power supply. 5-metre cable.

IP68



Design: Horst Lettenmayer © betec

Length	Colour	Light output	Article number
185 mm	V4A polished	21 Watt	22VA18PT21

Montagebeispiel:

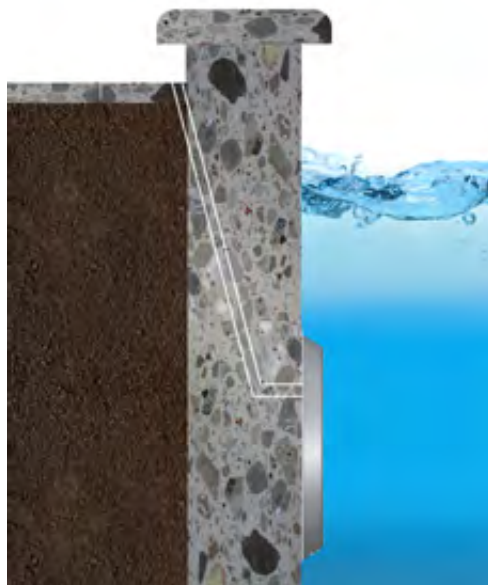

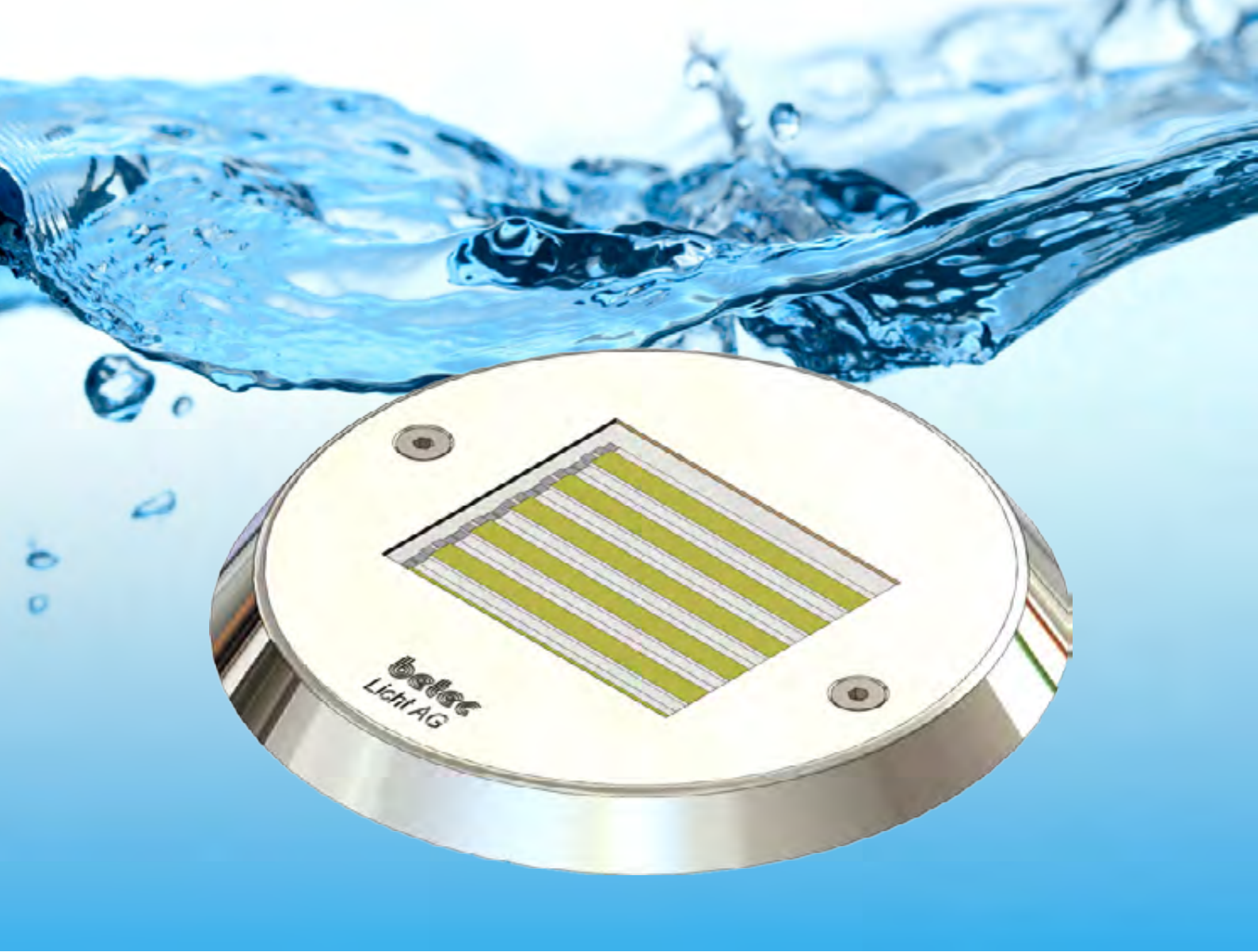

16 Planus

A complete lighting system with integrated transformer for max. 2 m busbar, which is snapped into the aesthetically shaped cover housing with a clip. The position of the conductor in the housing is variable. Centralised or projecting left-right. The standard Lux 1 spot has a joint that can be tilted by 180°. Version 2 comes with our Lux 3 spot, whose light reaches all areas thanks to a double gimbal joint. Application: lighting system for low ceilings, small rooms such as children's rooms, corridors, cloakrooms, stairwells; can also be used as a decorative wall lamp in cinemas or on columns.

LED efficiency class: A++, illuminant: LED, socket: GX 5.3, 1-30W ballast unit: 133 x 46 x 24 mm, dimmability: limited

Scope of delivery: transformer, busbar with 2 retaining clamps for the rail, spots (Lux 1 or Lux 3) without illuminant. The transformer colour is the same as the rail colour.

IP20



Design: Horst Lettenmayer © betec

Length	Colour	Article number
1000 mm 5 x Lux 1	White & Nickel	16WN01LD01
	White & Gold	16WG01LD01
	Black & Nickel	16SN01LD01
	Black & Gold	16SG01LD01
1000 mm 5 x Lux 3	White & Nickel	16WN01LD03
	White & Gold	16WG01LD03
	Black & Nickel	16SN01LD03
	Black & Gold	16SG01LD03
2000 mm 5 x Lux 1	White & Nickel	16WN02LD01
	White & Gold	16WG02LD01
	Black & Nickel	16SN02LD01
	Black & Gold	16SG02LD01
2000 mm 5 x Lux 3	White & Nickel	16WN02LD03
	White & Gold	16WG02LD03
	Black & Nickel	16SN02LD03
	Black & Gold	16SG02LD03

Als Zusatz gibt es folgende Spot Halterung mit Sockel GX5,3:

RRP without VAT

Lux 1	Black	69SL01OO05
Lux 1	White	69WL01OO05
Lux 3	Black	69SL03OO05
Lux 3	White	69WL03OO05



19 Galaxis

As far as its conductivity and light output capability is concerned, our galaxy system is the smallest low-voltage busbar system on the market. The circular conductor with a diameter of 15 mm integrates two conductor profiles of nickel-plated or gold-plated colour with a single cross-section of 55 mm². This means you can have a long rail control system without a drop in voltage. Single rails can be mechanically and electrically connected using plug pins or coupling shells. The toroidal transformer with 300 VA integrated in the system acts as a voltage source (dimmability is limited). Two triangular plates are used to supply power to the rail and for optimal adjustment within the room.

Transformer: 300 VA toroid with thermal switch and miniature fuse, light output: max. 250 watts, LED efficiency class: C, illuminant: MR16, socket: GX5.3, 300W encapsulated transformer: 140 x 50 x 37 mm, dimmable: yes (electrically), limited suitability for LED lamps

Scope of delivery: transformer, busbar with 2 retaining clamps for the rail, spots (Lux 1 or Lux 3) without illuminant. The transformer colour is the same as the rail colour.

IP20



Design: Horst Lettenmayer © betec

Length	Colour	Article number
1000 mm 5 x Lux 1	White & Nickel	19WN01TR01
	White & Gold	19WG01TR01
	Black & Nickel	19SN01TR01
	Black & Gold	19SG01TR01
1000 mm 5 x Lux 3	White & Nickel	19WN01TR03
	White & Gold	19WG01TR03
	Black & Nickel	19SN01TR03
	Black & Gold	19SG01TR03
2000 mm 5 x Lux 1	White & Nickel	19WN02TR01
	White & Gold	19WG02TR01
	Black & Nickel	19SN02TR01
	Black & Gold	19SG02TR01
2000 mm 5 x Lux 3	White & Nickel	19WN02TR03
	White & Gold	19WG02TR03
	Black & Nickel	19SN02TR03
	Black & Gold	19SG02TR03





Als Zusatz gibt es folgende Spot Halterung mit Sockel GX5,3:

RRP without VAT

Lux 1	Black	69SL010005
Lux 1	White	69WL010005
Lux 3	Black	69SL030005
Lux 3	White	69WL030005

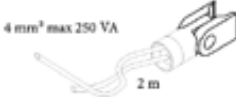

69 Galaxis & Planus

	Product	Version	Colour	Article number
	Lux 1 Clamp spotlight holder - without Illuminant	G4 Socket max. 35 Watt	Black White	69SL010004 69WL010004
		GX5,3 Socket max. 50 Watt	Black White	69SL010005 69WL010005
	Lux 3 Clamp spotlight holder - without Illuminant	G4 Socket max. 35 Watt	Black White	69SL030004 69WL030004
		GX5,3 Socket max. 50 Watt	Black White	69SL030005 69WL030005
	Pinza 1 Galaxis Rail bracket		Black White	69SO01PO00 69WO01PO00
 <p>4 mm² max 250 VA 2 m</p>	Pinza 2 Galaxis Rail bracket incl. electricity feed		Black White	69SO02PO00 69WO02PO00
	Pinza 3 Planus Rail bracket		Black White	69SO03PO00 69WO03PO00



69 Galaxis & Planus

The advantage of the galaxy system is that users, architects, planners and project planners can custom-design their lighting concept. Our pin connectors are the latest form of our connection technology, which connects the busbars to one another both mechanically and electrically, but without any effect on the decor. This requires a pin hole in the aluminium conductor.

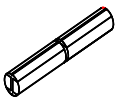
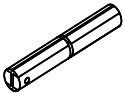
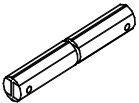
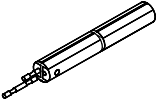
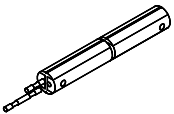
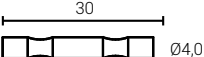
	Length	Colour	Article number
	1000 mm	White & Nickel	69WN00GL01
	2000 mm	White & Nickel	69WN00GL02
For coupling with decorative connectors:			
	Thread on one side		
	1000 mm	White & Nickel	69WN01GL01
	2000 mm	White & Nickel	69WN01GL02
	Thread on both sides		
	1000 mm	White & Nickel	69WN02GL01
	2000 mm	White & Nickel	69WN02GL02
For coupling with feed:			
	Pin hole on one side		
	1000 mm	White & Nickel	69WN01GS01
	2000 mm	White & Nickel	69WN01GS02
	Pin hole on both sides		
	1000 mm	White & Nickel	69WN02GS01
	2000 mm	White & Nickel	69WN02GS02
	Pin connector (Pair)	Brass	69MO10SV18

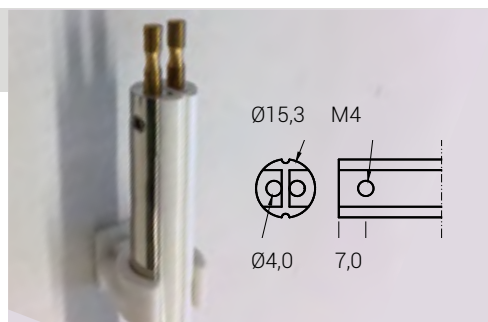

Colour	Article number
Black & Nickel	69SN00GL01
White & Gold	69WG00GL01
Black & Gold	69SG00GL01

51 Umrüstung Clarus

The EU Lamp Regulation affects both the 100W-80W incandescent lamp and small lamps. In this context, we would like to point out that we can no longer acquire the following festoons:

15V/5W, 18V/5W, 48V/5W

For reasons of increased light efficiency and a significantly increased lifespan of 50,000 hours, we will retrofit your picture lights that have festoon lamps using versions of the latest LED technology. Increased luminous efficacy with only 10% of the previous electricity consumption, without the lamp or the object heating up.

Illuminant: single LED, lifespan: 50,000 hours, LED efficiency class: A++, primary voltage: 220V-240V, secondary voltage: DC 24V, 20W ballast unit: 94 x 36 x 18 mm

For safety reasons, retrofittings may only be carried out by electrical industry specialists. Therefore, you should send your lamp to us for retrofitting.

IP20



Design: Horst Lettenmayer © betec

Length	Light output	Article number
265 mm	5 x 48V	51UB 26 MN24
475 mm	10 x 24V	51UB 47 MN24
595 mm	13 x 18V	51UB 59 MN24
725 mm	16 x 15V	51UB 72 MN24
900 mm	20 x 12V	51UB 90 MN24

LED Duo + Light colour:			-- -- -- M --
2400K	Warm tone	RA 80+ / 750 Lm	51 -- -- MW --
2700K	Neutral	RA 90+ / 1640 Lm	51 -- -- MN --
3000K	Daylight	RA 90+ / 750 Lm	51 -- -- MT --
3100K	Bright white	RA 90+ / 1640 Lm	51 -- -- MH --

Special option touch dimmer	Article number
-----------------------------	----------------



51TD06LD24

Special lamps

Project Phoenix Restaurant at the Dreischeibenhaus Düsseldorf

February 2016



Special lights made of stainless steel V2A with Halogène bulbs. Design and production of 30 hanging lights and table lamps with fabric-covered cables, designed by the company Kromayer. The perforated metal cylinders have been manufactured and enameled by a German contractor.

Project suburban railway station in Untermenzing

December 2005

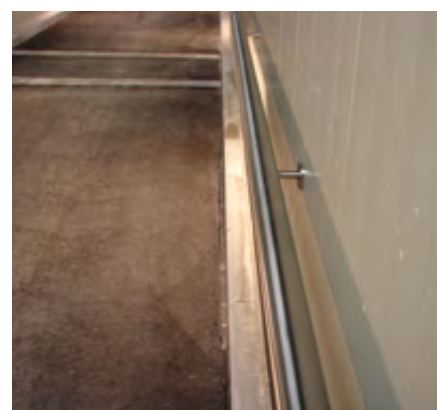

Long distance light for indoor and outdoor area lighting with fluorescent tubes. The light housing is made of anodised aluminium. The position of reflectors makes it possible to reflect 100% of the light output of the tube onto a flat surface. At the same time, permanently mounted tubes serve as a handrail strip.

Special lamps

Project Borgeaud bibliotheques, Médiathèque l'Apostrophe Chartres

March 2007



This light meets high photometric and aesthetic demands for the areas of architecture, interior design and the treatment of furniture. The ideal bookshelf lighting.

Project Théâtre du Capitole Toulouse

February 2002



If large paintings with powerful images are illuminated, a great picture light is required for the optical balance between the image and the light. Our "Maximus" can be adapted to optimally illuminate images with widths of several meters.

Special lamps

Library Technical University Garching

December 2017



Customization of the desk lamps with movable arm and console, including USB plug, on/off switch and Socle. 7 Watt, 4000 Kelvin LED light. Surface paint colour DB702.

Archbishop's Ordinariate / Palais Holnstein

September 2017



Wall lamp in the courtyards of the Archbishop's ordinariate. Design: Walter Bamberger / Technical implementation: betec Licht AG

Special lamps

Chandelier LED

April 2017



This chandelier was produced for a construction project in Munich, according to the design of Mr. Gottfried Riesner. We are pleased to continue to include this pendant light in our standard range.

Project Phoenix Restaurant at the Dreischeibenhaus Düsseldorf

February 2016

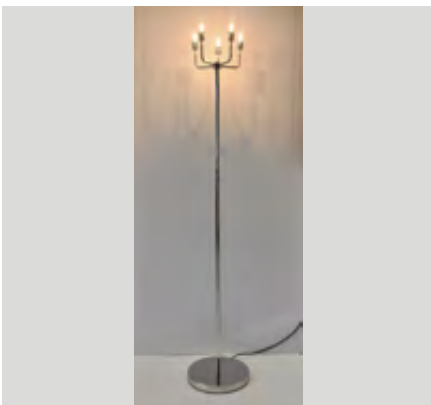

Special lights made of stainless steel V2A with Halogen bulbs. Design and production of 6 floor lamps, designed by the company Kromayer.

betec® General standard terms and conditions

All lamps deviating from this product range are custom-made lamps and are offered with corresponding surcharges! Initial orders are executed only against prepayment. Subject to technical changes. This catalogue is protected.

Imprint: Board of Director: Horst Lettenmayer, Product photography: Eugen Haller, Sessner Dachau, Layout: Julia-Alina Lettenmayer, Text: Horst Lettenmayer

1. General: with the order confirmation the buyer accepts our delivery conditions to be legally binding unless deviations hereto we agreed to before in writing. They are applicable without any exception in those cases in which the buyer regards his conditions as the only decisive ones. Our silence in regard to the conditions of the purchaser can under no circumstances be regarded as acceptance of same. Any non-compliance with our conditions by the purchaser authorizes us to take the necessary legal steps. Every agreement with us or our representatives needs our written confirmation. The use of the Uniform Laws of 17. July 1973 on the International Purchase of movable items and the closing of International Purchase Orders is excluded.
2. Offers are subject to alteration without notice and are not binding in regard to delivery. We can neither be held responsible for malshipments due to misunderstanding in telexes, telephone, cable, fax or oral information nor from otherwise incomplete or unclear statements, documentation, drawings, samples etc.
3. Prices are ex works, excluding packaging, plus VAT. The agreed prices are based on the cost factor existing at the time of ordering. We retain the right to price corrections in case the cost factors change due to wage- and material price increases, additional working steps in special makes, etc.
4. The duty to deliver will not be cancelled through delayed partial shipments or constant objections, especially in case of custom-made items, Contract completed orders are subject to recall within the agreed period, at the latest after six months. Thereafter we are entitled to either deliver the remainder of the order or cancel the rest. a) A return of goods will only be credited in case of previous consent. The undamaged products in original packaging will be credited with 80% of the invoice price. Necessary extra work and packaging costs plus transportation charges will be subtracted without any prior notice. Custom-made products will not be reaccepted. b) The minimum order value for any shipment is € 50,- (without VAT). For deliveries below this amount a proportionate processing charge of € 10,- (excl. VAT) plus the packaging and shipment costs will be charged. c) Whenever planning or production of special equipment became necessary for the make of the cancelled goods, then those costs will also have to be reimbursed completely; furthermore expenses for any pre-material plus their respective stock and administration charges as far as not intended for any other purpose. Any failures resulting from force majeure or disturbances internally or at our suppliers' plus non-compliance with our payment conditions does not release us from our duty of delivery and justify no claims for compensation. Basically, we can only be bound to delivery if the credit-worthiness of the purchaser is beyond all doubt. A basic ruling of this company is that first orders are subject to C.O.D. deliveries. Our new customers therefore allow us with their first order to send an advance invoice at the latest when goods are ready for shipment which they may regulate with discount. After receipt of payment we will then immediately undertake the shipment. For slow customers the C.O.D.-delivery remains ineffect.
5. The given delivery time is dependent upon the prerequisite of a smooth business course and an even production run together with the timely receipt of necessary raw materials. Our information is calculated from the date of confirmation, resp. clarification of all details and refer to the shipment date ex works. An extension of delivery time may be given, e.g. if the purchaser does not keep our business conditions.
6. Tolerances in regard to measurement and material are to be granted as is common also for those according to drawings. Claims exceeding these are subject to a respective surcharge.
7. Special makes, differing from the standard version can only be considered if included in the order or

furnished with an order no. If a special product- in spite of most careful planning and calculation - can not be made as laid down in the offer, the purchaser is not entitled to ask for damages. Any costs for the make of tools and samples are to be reimbursed in any case.

8. Packaging is invoiced at prime cost and due to lack of regulations is done in our judgment. The prompt acceptance of the goods through the Post Office, Railway etc. confirm the faultless packing of our goods.

9. Dispatch of goods takes place on account of the purchaser: The risk is transferred to the purchaser the moment the goods leave the factory, disregarding whether free of charge, fob or CIF shipments were agreed. If no special transportation mode and no special way are specified, we select the transportation means ourselves. Foreign carriage cannot be compensated. We cannot be held liable for any delays or additional costs for the transportation. We are at all times entitled to shipment by C.O.D., ask for advance payment resp. insure the goods for a small fee.

10. Complaints in regard to number resp. quality of goods can only be considered, if they were handed in in writing within 7 days after receipt of goods. Evidently faulty goods that are still in the shipment state, will be replaced or reworked only irrespective the right to reduce the remuneration or cancel the order when failing the afterwork or replacement delivery, if goods are being returned to us within the permissible complaint period and amounts to more than 5% of the whole shipment. A return of shipped goods may only take place with our consent. All replaced goods will come into our ownership. Further claims, espec. damages, reimbursement of wages and materials are excluded. Our liability for all faults will expire if the purchaser of our products mixes them with items of different origin, reworks himself faulty products or does not meet this contractual obligations. Lamps are technical working means according to the product safety law and may only be used for their intended purposes. Any use of lamps and supplementary parts contrary to their purpose as well as unauthorized changes on our lamps without our prior written consent releases us from all liabilities in case of damage. For losses and damages during transportation the recipient must have those immediately certified with the train- or post office authorities and file claims for compensation there.

11. Reservation of Title. We retain the right of ownership of the delivered goods, even if subsequently treated, until the fulfillment of all claims from this contract. Even if our goods will be connected with other items, the purchaser may only sell the goods under reserved title. Claims from a resale of the reserved goods are to be ceded irrevocably to us in the amount of our claims including interest and costs. In case of possible inability of payment, composition settlement or even pledging resp. bankruptcy of the purchaser, same is bound to return the reserved goods unasked and free of charge. Pawning, protective conveyance or a sale of the reserved goods is excluded. We retain the right to reclaim the reserved goods until their full payment. The enforcement of § 28 VO is excluded.

12. Our invoices are payable within 14 days from invoice date with 2% discount on the net product value or within 30 days net to one of the accounts mentioned on the next page or by cheque to our address. With C.O.D. shipments and immediate advance payment we grant 2% discount on the net product value. We will not accept bills of exchange. Only after their discharge will cheques be regarded as payment. Bank discounts or other expenses are to be charged to the customer. Deductions for transportation or packing costs are inadmissible. Payments because of complaints may under no circumstance be delayed. In case a purchaser does not meet his liabilities, we are entitled to stop further shipments until complete payment. Whenever the deadline for outstanding payments is exceeded, the purchaser - without being specially informed by us - will be levied with an interest that is common for unpaid credits with banks. Extension of time, counterclaims or retention of partial payments, no matter what the reason may be, are excluded without our prior written consent. All expenses arising from a reminder, delayed payment, confiscation or non-acceptance of ordered goods must be borne by the purchaser. Any telephone/cable charges, etc. by the purchaser are also excluded.

13. The guarantee for our products amounts to 24 months. Longer-lasting guarantees must be agreed separately. The guarantee does not refer to bulbs and transformers.

14. Place of performance for shipments and payments is Munich exclusively. The law of Germany applies to our delivery conditions and all legal connections between the purchaser and us.

15. Special regulations or any possible legal ineffectiveness of individual points of these delivery conditions do not infringe the validity of the others.

