

the
COLLECTION



FURNITURE & LIGHTING

DESIGNED BY VERNER PANTON
MANUFACTURED BY VERPAN

VERPAN

Verner Panton
© Verner Panton Design

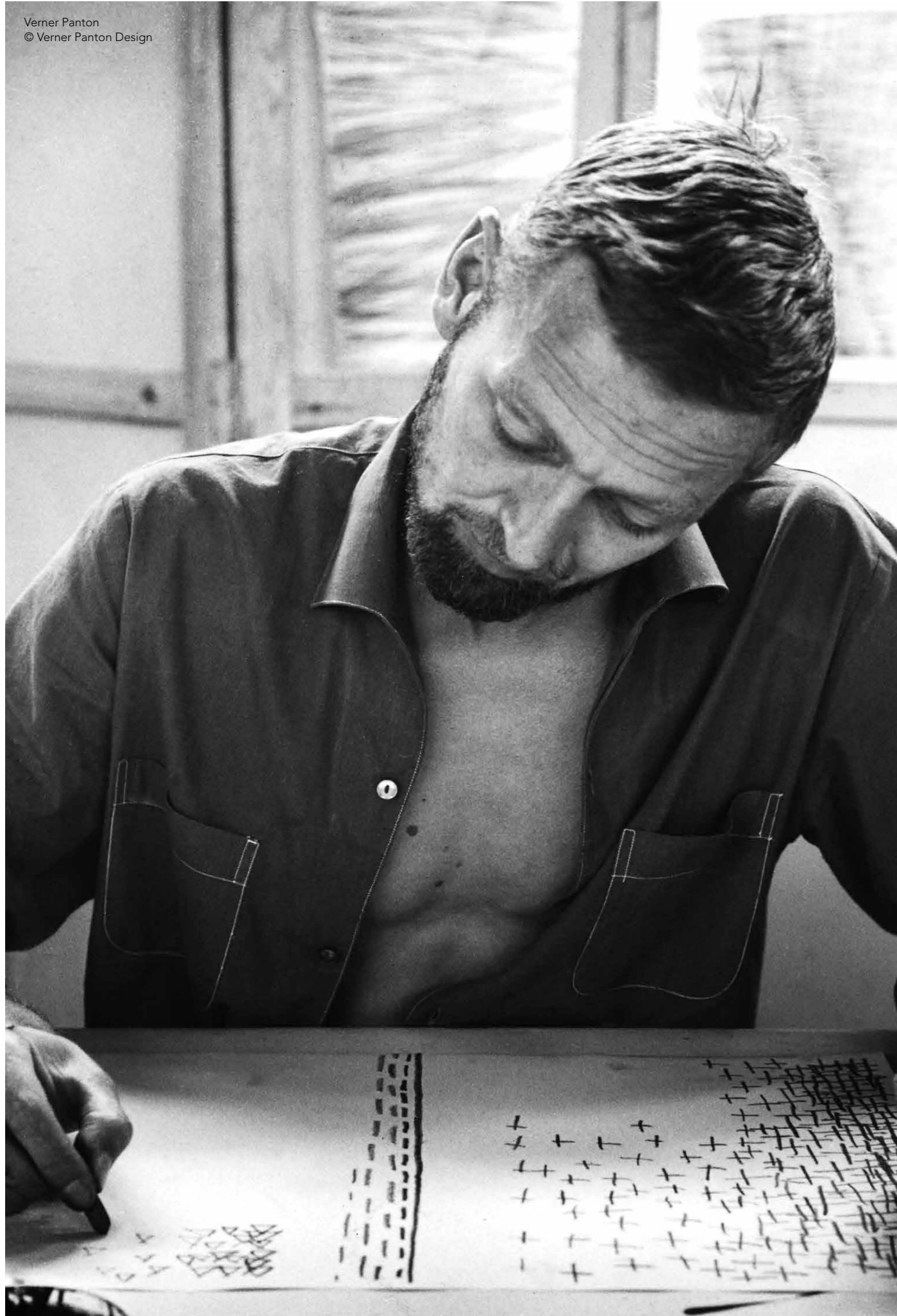

VERPAN

Verner Panton

Among the giants of Danish design, Verner Panton established a unique reputation for his exuberant originality and tireless experimentation. Panton created lamps, furniture and textiles – and was also a sought-after interior designer. Although he was at the forefront of mid-century Danish Modern, Panton's contribution was anything but mainstream.

He enthusiastically embraced new materials, he splashed with a bold colour palette, and he playfully imbued many of his sculptural creations with a strong graphical expression – without ever compromising on quality or workmanship.

Panton's iconic designs have emerged as contemporary design classics – as strikingly inventive now as they were 50 years ago.

Verpan is - much like Verner Panton - a product of the Danish design tradition, which have put Denmark on the world map for functional, modern and unique design.

The story of Verpan began in 2003, when the first production of Verner Panton lighting was initiated. In 2010 a furniture range was added. A continuous process of picking and choosing products from the vast treasure chest of Panton's work ensures a strong portfolio of amazing designs.

Verpan is proud to carry on the legacy of Verner Panton as an official licensee of Verner Panton Design AG - the exclusive owner of all Verner Panton designs.

VERPAN

CON TENTS

SPACES	06-07
SUSTAINABILITY	08-09

FURNITURE

CLOVERLEAF COLLECTION	14-31
PANTO POP	32-33
VP168 SOFA	34-37
WELLE	38-43
FLYING CHAIR	44-47
FLEX CHAIR	48-55
SERIES 430 COLLECTION	56-87
MOVE TABLE	88-89
SYSTEM 1-2-3 COLLECTION	90-101
BARBOY	102-105
MIRROR SCULPTURES	106-107
RUGS	108-113
THROWS	114-117
UPHOLSTERY PROGRAM	118-119

LIGHTING

FUN COLLECTION	122-139
VP GLOBE COLLECTION	140-151
VP PANTO	152-155
HIVE	156-159
SPIEGEL	160-163
BALL	164-165
SPIRAL COLLECTION	166-175
PANTOP COLLECTION	176-179
REFLECT	180-183
WIRE COLLECTION	184-187
MOON	188-195
ONION	196-197

SPACES

The Verpan product range offers extraordinary user experiences and facilitate new ways of living, working and interacting.

Panton's designs integrate with the surroundings through shape, motion, light and sound.

Our products are all contract certified as standard and made using modern manufacturing methods ensuring compliance with international environmental standards.

Our track record include residential, restaurants, hotels, corporate, retail stores, education, airports and more.

Discover more
www.verpan.com



SUSTAINABILITY

At Verpan we care about our social and environmental responsibilities.

We offer timeless design of high quality with long product life. Pantón's work continues to represent a high value, making a great case for resale or donation of product at end-of-use.

We introduce recyclable materials when possible and strive to develop products for easy assembly and disassembly - making it possible to replace and ultimately dispose damaged parts properly.

We work closely with our suppliers and logistics partners to ensure optimal production methods and minimize shipping and packaging.



Recyclable.

The Cloverleaf In- & Outdoor Sofa is a great example of how our efforts materialize in real life. The sofa is extremely durable and made from 100% recyclable rotational molded PE polyethylen, meaning that at end-of-life, the material can be granulated and reused.

The sofa is modular and damaged parts can easily be replaced and ultimately disposed of properly.



Construction.

In addition to the seat and back being manufactured in 100% recyclable polypropylene (PP), the Flex chair is assembled with standard screws, making it possible to disassemble the chair to replace parts and extend the product's lifecycle and ultimately dispose of parts in an environmentally friendly manner.

**“One sits more
comfortably on
a colour that
one likes.”**

- Verner Panton

FURNITURE

CLOVERLEAF

Sofa

by Verner Panton, 1969

WHY WE LOVE IT

Unique yet highly functional design
Great seating comfort and support
Infinite seating options
Modular and highly customizable
Great for high traffic areas

SUGGESTED APPLICATION

Airport
Care
Learning
Work
Hospitality

MATERIAL

FSC-approved wood frame (18 mm/0.7" plywood & pine wood)
CMHR (CRIB 5) or HR (Cal 117) foam for seat and backrest
Metal interlockers
Adjustable nylon glides

DIMENSIONS

LEFT AND RIGHT UNIT

L: 114.5 cm (45.1")
W: 115.5 cm (45.3")
H: 80 cm (31.5")
Seat height: 40 cm (15.7")
Weight: 112 kg.

EXTENSION UNIT

L: 130 cm (51.2")
W: 113 cm (44.5")
H: 80 cm (31.5")
Seat height: 40 cm (15.7")
Weight: 135 kg.

MIDDLE UNIT

L: 142 cm (55.9")
W: 158 cm (62.2")
H: 80 cm (31.5")
Seat height: 40 cm (15.7")
Weight: 142 kg.

STANDARD UPHOLSTERY OPTIONS

Kvadrat
Skai
JAB
Dedar
Sørensen Leather

MADE-TO-ORDER OPTIONS

Integrated power/charging station
COM upholstery
Plinth

UNITS

LEFT

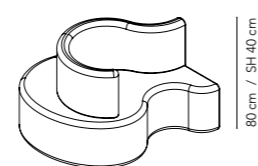
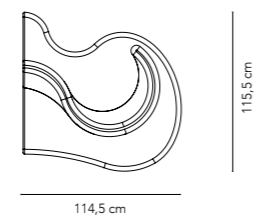

RIGHT

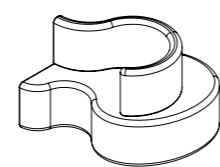
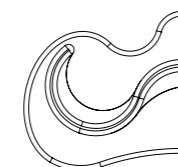

MIDDLE

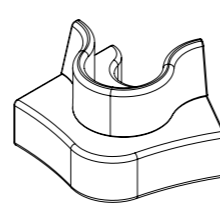
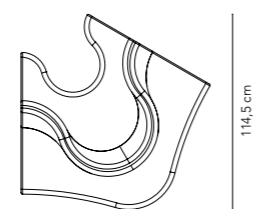

EXTENSION

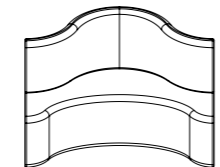
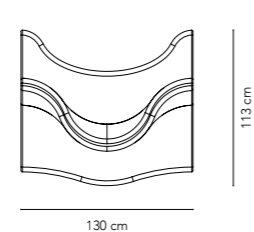

Reference: ARoS Museum of Art
Product: Cloverleaf Sofa (5-unit)
Upholstery: Hallingdal 220 / Kvadrat



CORPORATE

BESTSELLER HQ

Aarhus, Denmark

For Bestseller's HQ in Aarhus, the clothing company chose one three-unit and two five-unit Cloverleaf sofas for the large entrance/waiting area.

The organic expression of the Cloverleaf sofa gently breaks up and softens the space - perfectly complementing the beautiful architecture.

COLLECTION



Upholstery
Five-unit: Outback 851 / Kvadrat
Three-unit: Tonica 832 / Kvadrat
Five-unit: Harald 3.182 / Kvadrat



VERPAN

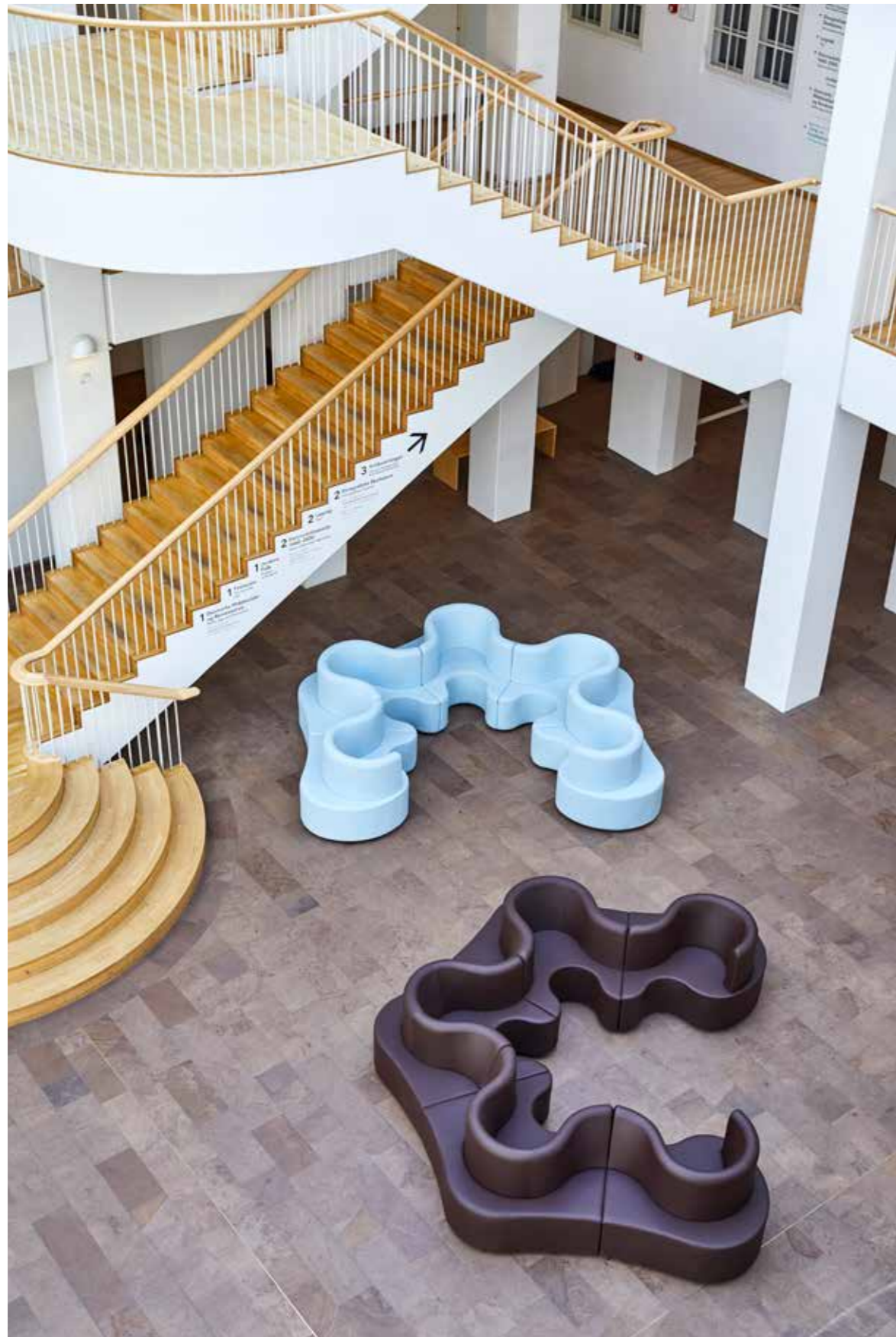

Reference: The Museum of National History / Copenhagen
 Product: 2 x Cloverleaf Sofa (5-unit)
 Upholstery: Pandoria Plus F6413051 (schoko) & F6413055 (gletscher) / Skai
 Architect: Paustian





Reference: Restaurant Brahms Haus Der Musik / Innsbruck
Product: Cloverleaf Sofa (5-unit)
Upholstery: Harald 3 182 / Kvadrat
Photo credit: Günther Egger

AIR PORT



SEATTLE-TACOMA INTERNATIONAL AIRPORT

Seattle, Washington

A collection of upholstered Cloverleaf sofas with integrated power. The organic and sculptural design softly breaks the lines of the otherwise strict layout of the airport and offers a fun and colourful alternative to the classic Vitra seating system.

Image credit: Vitra

CLOVERLEAF

In- & Outdoor

by Verner Panton, 1969

WHY WE LOVE IT

- 100% recyclable material
- Works equally great indoors and outdoors
- Infinite seating options
- Modular and highly customizable
- Extremely durable
- Easy to clean and maintain

SUGGESTED APPLICATION

- Outdoor
- Care
- Learning
- Work
- Hospitality

MATERIAL

100% recyclable rotational molded PE polyethylen.

DIMENSIONS

LEFT AND RIGHT UNIT

L: 114.5 cm (45.1")
W: 115.5 cm (45.3")
H: 80 cm (31.5")
Seat height: 40 cm (15.7")
Weight: 40 kg.

EXTENSION UNIT

L: 130 cm (51.2")
W: 113 cm (44.5")
H: 80 cm (31.5")
Seat height: 40 cm (15.7")
Weight: 47 kg.

MIDDLE UNIT

L: 142 cm (55.9")
W: 158 cm (62.2")
H: 80 cm (31.5")
Seat height: 40 cm (15.7")
Weight: 51 kg.

STANDARD COLOURS



MADE-TO-ORDER OPTIONS

- Integrated power/charging station
- Custom RAL colours
- Plinth (indoor use only)

UNITS

LEFT

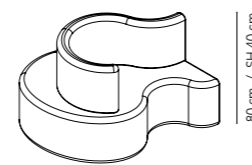
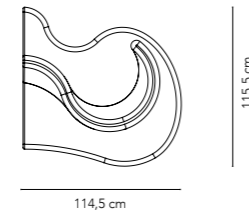

RIGHT

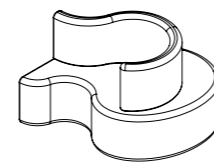
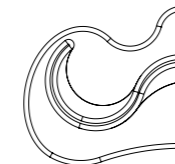

MIDDLE

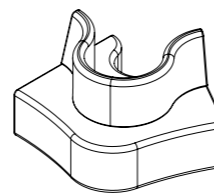
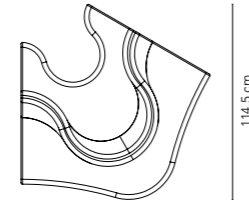

EXTENSION

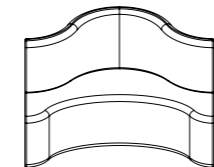
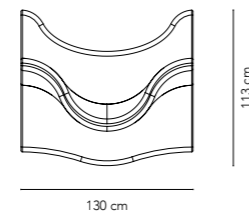

Reference: KPN Tower / Rotterdam
Product: Cloverleaf In- & Outdoor (5-unit)
Colour: Standard white
Photo credit: Annette Prinssen

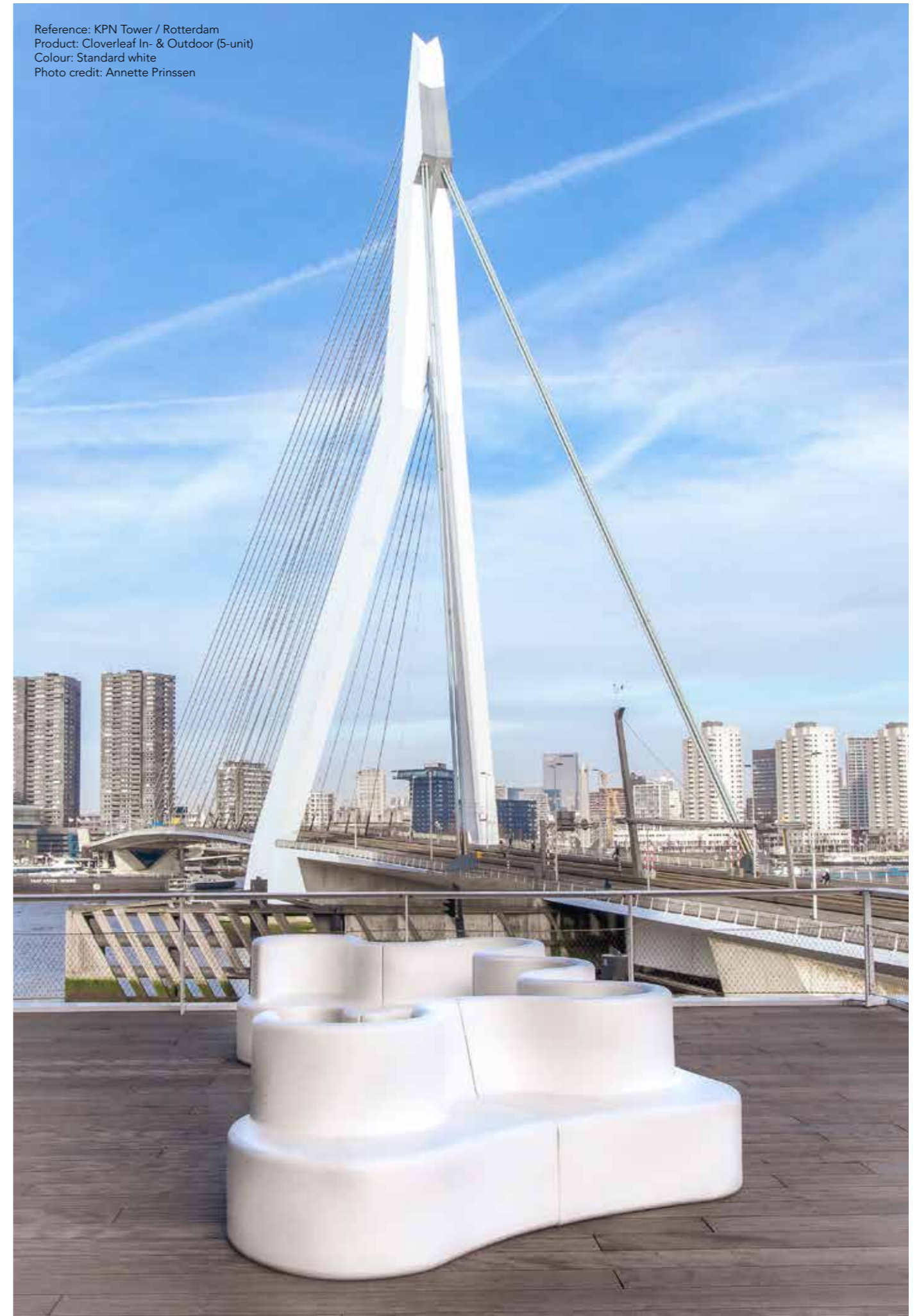



Reference: Danish Architecture Center / Copenhagen
Product: Cloverleaf In- & Outdoor (6-unit)
Colour: Custom RAL
Architect: Danielsen Space Planning & Holmris B8



Reference: Street Food / Aarhus
 Product: Cloverleaf In- & Outdoor (4-unit)
 Colour: Standard white



CLOVERLEAF SOFA

Space Management

350 cm

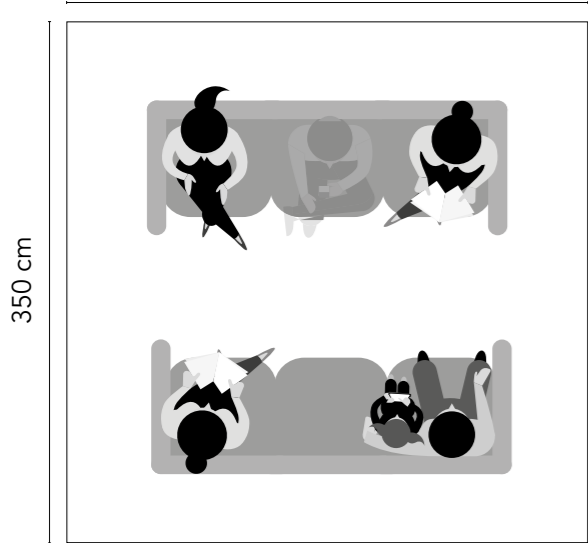

Max. 6 seats

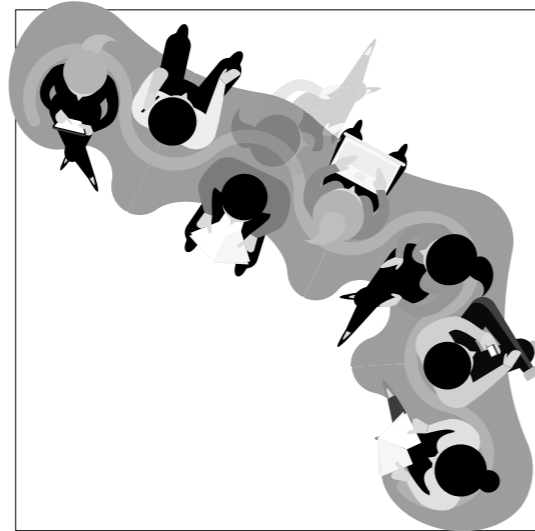

Min. 7 seats

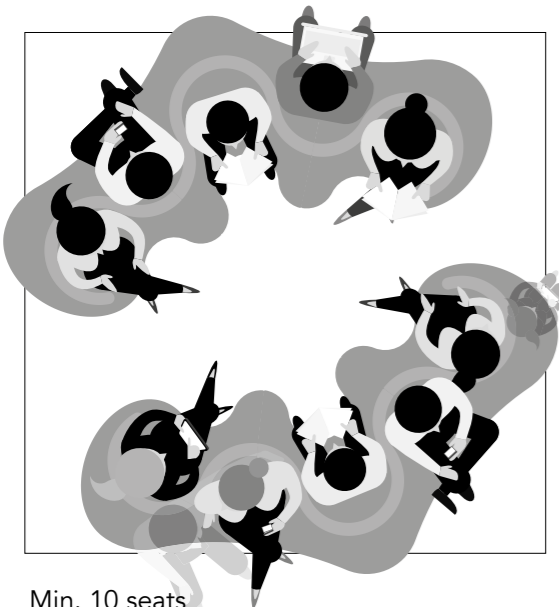

Min. 10 seats

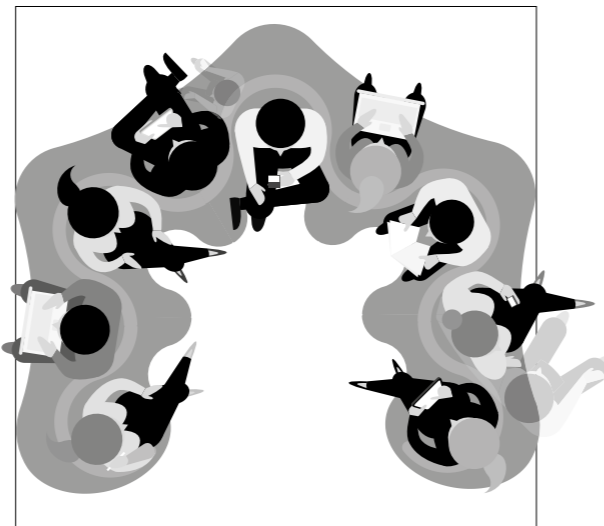

Min. 11 seats

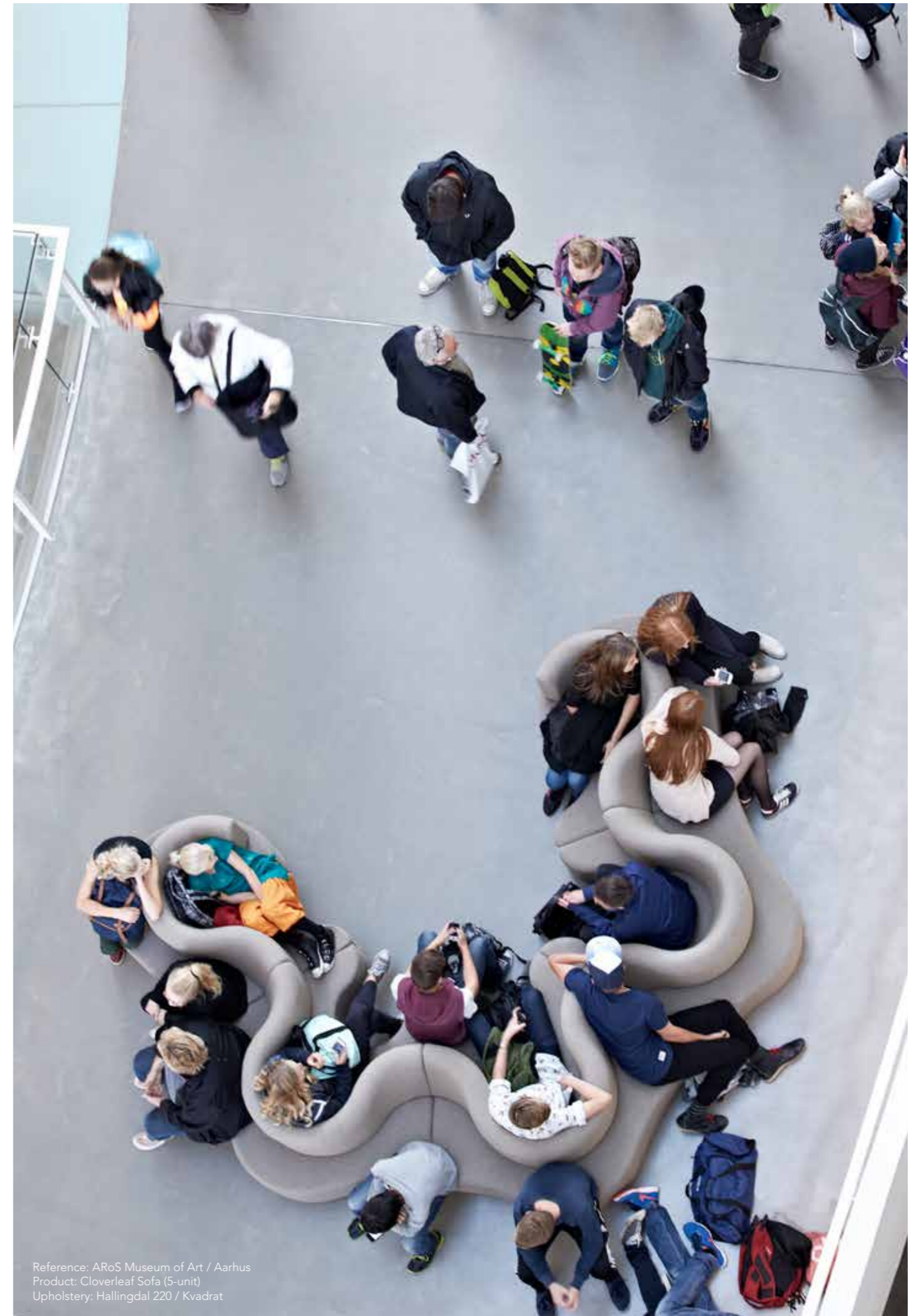

Reference: ARoS Museum of Art / Aarhus
Product: Cloverleaf Sofa (5-unit)
Upholstery: Hallingdal 220 / Kvadrat

PANTO POP

Lounge Chair

by Verner Panton, 1969

WHY WE LOVE IT

Outdoor use
Great for occasional use
Stackable
Easy to move and store

SUGGESTED APPLICATION

Outdoor
Learning
Care
Hospitality
Work

MATERIAL

ABS resin

DIMENSIONS

H: 54 cm (21.3")
Ø81 cm (31.8")
Weight: 4 kg.

COLOURS

White

MADE-TO-ORDER OPTIONS

Custom colours

DETAILS

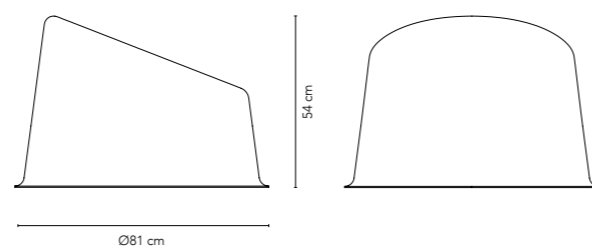

Reference: Læssøesgade School / Aarhus
Product: Panto Pop

VP168

Sofa

by Verner Panton, 1987

WHY WE LOVE IT

Fully upholstered three-seater with pocket springs
Spacious and comfortable lounge sofa
Significant and balanced proportions
The enveloping design creates a private space
Comes with a set of matching pillows

SUGGESTED APPLICATION

Care
Learning
Work
Hospitality
Residential

MATERIAL

Frame and base in FSC certified wood
CMHR (CRIB 5) or HR (Cal 117) foam for seat and backrest
Pocket springs in seat
Pillows filled with natural feathers

DIMENSIONS

Length: 253,5 cm (99.8")
Depth: 95 cm (37.4")
Height: 78,8 cm (31")
Seat height: 43,8 cm (17.2")
Weight: 110 kg.

STANDARD UPHOLSTERY OPTIONS

Kvadrat
Skai
JAB
Dedar
Sørensen Leather

MADE-TO-ORDER OPTIONS

COM upholstery

DETAILS

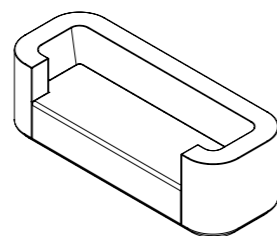
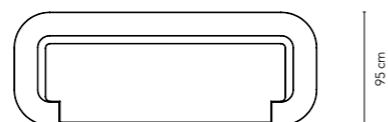
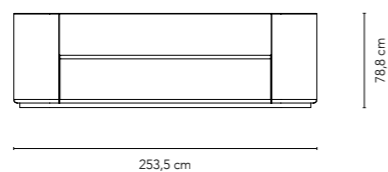



Upholstery:
VP168 Sofa - Harald 3 982 / Kvadrat
System 1-2-3 Lounge - Pilot 972 / Kvadrat

WELLE

Lounge Chairs

by Verner Panton, 1969

WHY WE LOVE IT

Very versatile - use as single piece or create your own landscape
Fun & organic design
Highly comfortable
Great for social interaction

SUGGESTED APPLICATION

Care
Learning
Work
Hospitality
Residential

MATERIAL

FSC-approved wood frame (15 mm/0.6" plywood)
CMHR (CRIB 5) or HR (Cal 117) foam

DIMENSIONS

WELLE 1

L: 162 cm (63.8")
H: 102 cm (40.2")
W: 50 cm (19.7")
Weight: 26,5 kg.

WELLE 4

L: 140 cm (55.1")
H: 63 cm (24.8")
W: 50 cm (19.7")
Weight: 16 kg.

WELLE 2

L: 108 cm (42.5")
H: 80 cm (31.5")
W: 50 cm (19.7")
Weight: 17,5 kg.

WELLE 5

L: 108 cm (42.5")
H: 40 cm (15.7")
W: 50 cm (19.7")
Weight: 12 kg.

WELLE 3

L: 240 cm (94.5")
H: 70 cm (31.5")
W: 50 cm (19.7")
Weight: 33 kg.

WELLE 6

L: 54 cm (21.3")
H: 40 cm (15.7")
W: 50 cm (19.7")
Weight: 5,5 kg.

STANDARD UPHOLSTERY OPTIONS

Kvadrat
Skai
JAB
Dedar
Sørensen Leather

MADE-TO-ORDER OPTIONS

Integrated power/charging station
COM upholstery
Plinth

UNITS

Welle 1

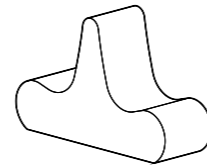
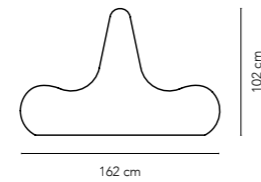

Welle 2

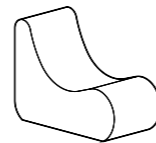
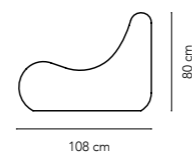

Welle 3

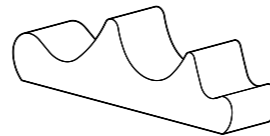
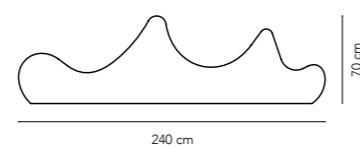

Welle 4

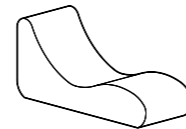
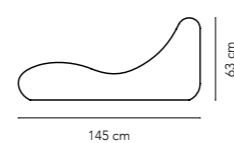

Welle 5

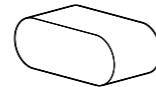
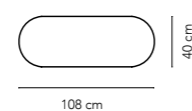

Welle 6

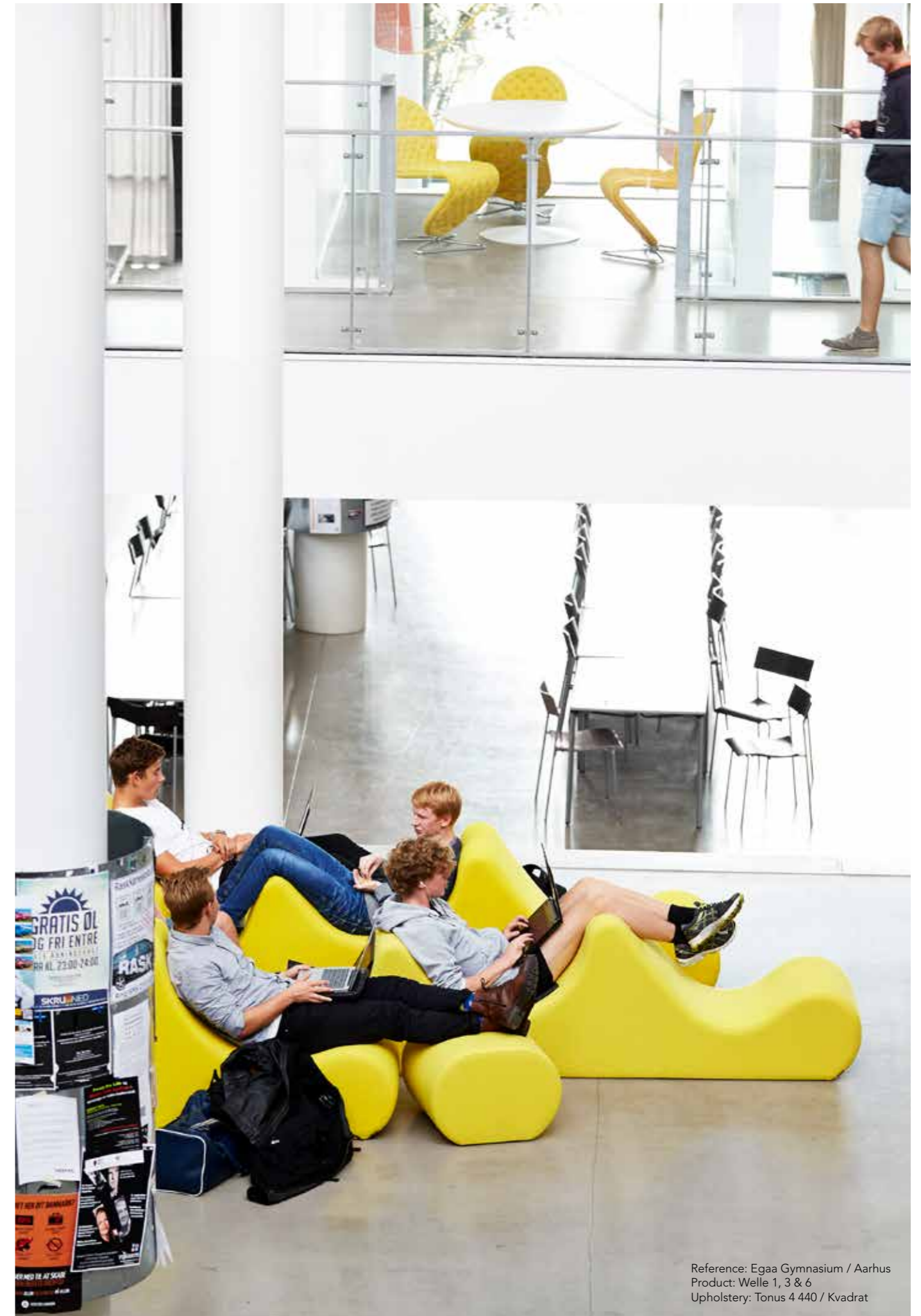
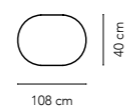

Reference: Egaa Gymnasium / Aarhus
Product: Welle 1, 3 & 6
Upholstery: Tonus 4 440 / Kvadrat



Reference: Egaa Gymnasium / Aarhus
Product: Welle 1, 3 & 6
Upholstery: Tonus 4 440 / Kvadrat

LIBRARY

SELSDON PUBLIC LIBRARY

South Croydon, London

After being closed for two months for a major refurbishment, Selsdon Library in London, reopened with a completely new and fresh look. For the project, Verpan has supplied a number of the comfortable Welle 2 lounge furniture.

Photo credit: Form Fit-Out

COLLECTION



Upholstery: ParotegaF6461664 Amethyst / Skai

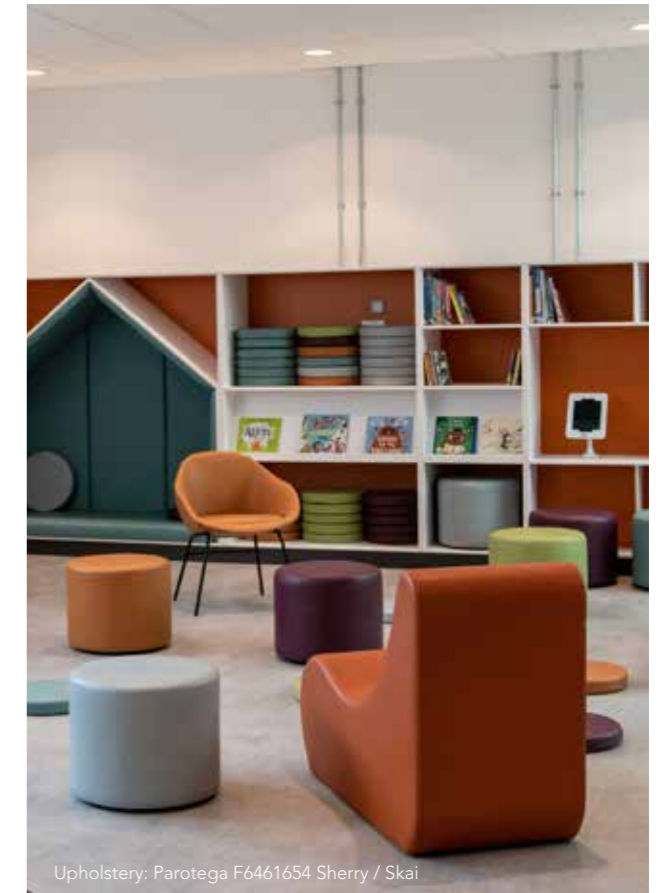

Upholstery: Parotega F6461654 Sherry / Skai



FLYING CHAIR

Lounge Chair

by Verner Panton, 1964

WHY WE LOVE IT

Iconic Panton design
Adjustable suspension lounge chair
Fun and interesting piece for creative spaces
Inspires you to think differently

SUGGESTED APPLICATION

Learning
Work
Hospitality
Residential

MATERIAL

FSC-approved form pressed plywood
Supporting steel frame
PU foam
Polyester ropes with steel fixtures

DIMENSIONS

Length: 150 cm (59")
Width: 80 cm (31.5")
Hanging height/rope length: 200 cm (78.7")
Weight: 23 kg.

STANDARD UPHOLSTERY OPTIONS

Kvadrat
Skai
JAB
Dedar
Sørensen Leather

MADE-TO-ORDER OPTIONS

COM upholstery

DETAILS

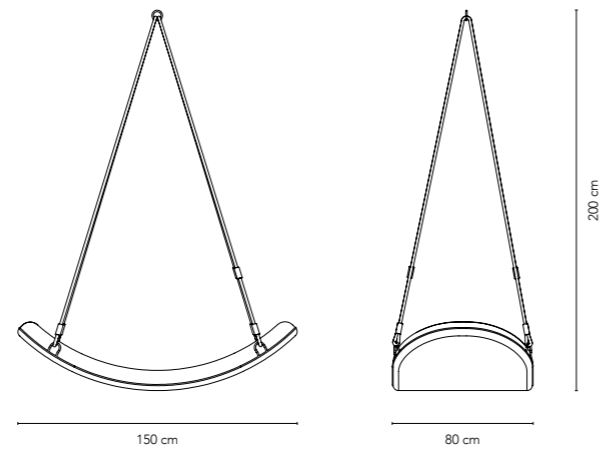

Upholstery: Vidar 472 / Kvadrat

Reference: Exhibition Space / Innsbruck
Product: Flying Chair
Upholstery: Hallingdal 600 / Kvadrat
Photo credit: Günther Egger



FLEX

Chair

by Verner Panton, 1960

WHY WE LOVE IT

Sculptural organic aesthetics
Thoughtful ergonomics gives great seating comfort
Very versatile & stacks for easy storage
Made from 100% recyclable PP
Easy to disassemble for repair and ultimately disposal

SUGGESTED APPLICATION

Care
Learning
Work
Hospitality
Residential

MATERIAL

Polypropylene (PP) seat and backrest
Painted metal frame
Plastic gliders with felt feet

DIMENSIONS

Height: 89 cm (35")
Seat height: 46 cm (18.1")
Seat width: 42,8 cm (16.8")
Total depth: 53,5 cm (21")
Total width: 50,5 cm (19.9")
Weight: 7 kg.

STANDARD COLOURS



MADE-TO-ORDER OPTIONS

Custom colour painted frame
Custom colour seat and backrest
Upholstered seat and back
Linking
Stacking cart

DETAILS

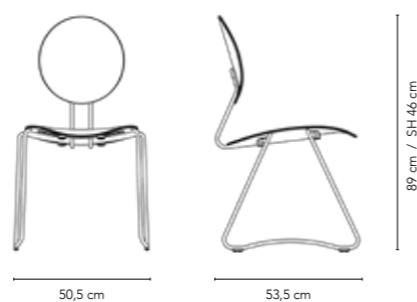



FLEX CHAIR

True to Panton's heritage, the Flex chair features exceptional ergonomic features, simple organic aesthetics and a functional and pragmatic approach to materials. The multi-purpose and stackable chair is tested and certified for contract use and works perfect for anything from conference, hospitality, hotel and other public spaces.

Panton designed the characteristic shape of the seat and back to fit the contours of the human body – providing proper lumbar support and secure a healthy blood flow to the legs. In addition, the frame is designed to offer flexibility and bounce – further improving the seating experience.

The seat and backrest is made from 100% recyclable polypropylene (PP), a material known for its crisp and pleasant surface character, high rigidity, durability and scratch resistant qualities. The chair sits on a powder-coated sledge steel frame. Flex chair is available in black and slate.





SERIES 430

Chair

by Verner Panton, 1967

WHY WE LOVE IT

Outstanding comfort
Understated elegance
Highly customizable
Super versatile
Easy to clean
Fully upholstered

SUGGESTED APPLICATION

Learning
Care
Hospitality
Work
Residential

MATERIAL

FSC-approved wood for seat and back
Elastic band webbing in the seat
CMHR (CRIB 5) or HR (Cal 117) foam
Brushed stainless steel frame (steel)
Painted or plated metal frame (black, white, burgundy & brass)
Felt feet

DIMENSIONS

Height: 82 cm (32.3")
Seat: Ø46 cm (17.7")
Seat height: 47 cm (18.1")
Total depth: 51,5 cm (20.3")
Total width: 54 cm (21.3")
Weight: 6,3 kg.

STANDARD UPHOLSTERY OPTIONS

Kvadrat
Skai
JAB
Dedar
Sørensen Leather

FRAME OPTIONS



MADE-TO-ORDER OPTIONS

Custom colour painted frame
COM upholstery
Linking

DETAILS

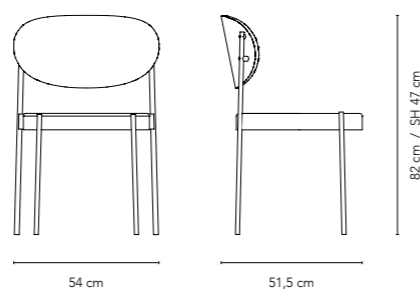

Upholstery: Harald 3 182 / Kvadrat



Upholstery: Vidar 3 333 / Kvadrat







Reference: Restaurant Beefbar / Budapest
Product: Series 430 Chair
Upholstery: COM
Photo credit: Beefbar Budapest



THE STUDENT HOTEL

Maastricht, Netherlands

Series 430 Chair for The Student Hotel in Maastricht.

Located in a former factory, the restaurant interior is bold and vibrant. It celebrates the heritage of both the site and the production process which used to take place in the old building.

The fresh interior is filled with playful objects and elements, while an industrial theme can be seen across the 3 levels of the restaurant.

Architect: Studio Modijefsky
Photo credits: Maarten Willemstein



Upholstery: COM



ROYAL OPERA HOUSE

After a three-year remodelling steered by Stanton Williams architects, the historic Royal Opera House in Covent Garden, London opens to the public. The remodelling project, dubbed 'Open Up' is an effort to make the space more accessible for a wider audience.

The Series 430 chair accompanies other design classics in the restaurant.

Architect: Stanton Williams
Photocredit: James Newton



Upholstery: Savanna 222 & 262 / Kvadrat



Reference: Hotel Imperial / Copenhagen
Product: Series 430 Chair
Upholstery: Parotega F6461653 Kiesel / Skai



1HOTEL BROOKLYN BRIDGE

Brooklyn, New York

Named one of the 10 Best Hotels in New York City in Condé Nast Traveler's 2019 Choice Awards.

With spectacular views of the Manhattan skyline and the Brooklyn Bridge, this chic eco-friendly hotel is thoughtfully designed with an incredible attention to organic and sustainable solutions, such as LED lighting, recycled materials and a top-class farm-to-table restaurant.

The hotel is a popular venue for weddings, conferences and seminars.

Photo credit: 1Hotel Brooklyn Bridge

Upholstery: Main Line Plus Charcoal [View](#) Camilla Fabrics

SERIES 430

Bar Stool

by Verner Panton, 1967

WHY WE LOVE IT

Outstanding comfort
Understated elegance
Highly customizable
Super versatile
Easy to clean
Fully upholstered

SUGGESTED APPLICATION

Learning
Care
Hospitality
Work
Residential

MATERIAL

FSC-approved wood for seat and back
Elastic band webbing in the seat
CMHR (CRIB 5) or HR (Cal 117) foam
Painted or plated metal frame (black & brass)
Felt feet

DIMENSIONS

Seat height/height: 65 cm (25.6") / 100 cm (39.4")
Seat height/height: 75 cm (29.5") / 110 cm (43.3")
Seat: Ø46 cm (17.7")
Total depth: 51,5 cm (20.3")
Total width: 54 cm (21.3")
Weight: 10/11 kg.

STANDARD UPHOLSTERY OPTIONS

Kvadrat
Skai
JAB
Dedar
Sørensen Leather

FRAME OPTIONS



Black Brass

MADE-TO-ORDER OPTIONS

Custom colour painted frame
COM upholstery

DETAILS

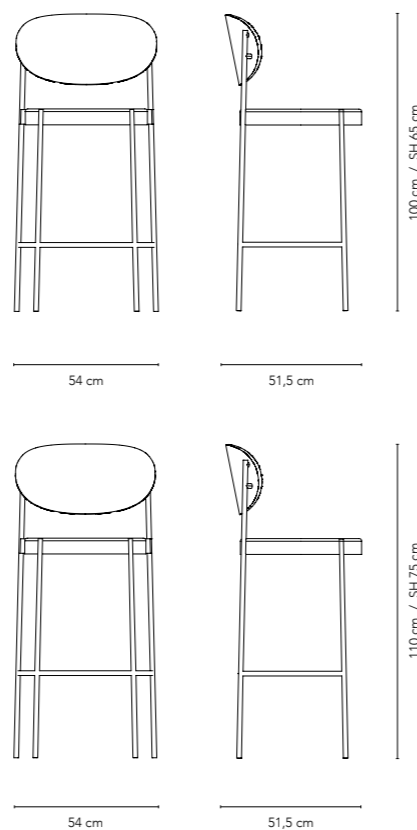

Reference: Hydro HQ / Oslo
Product: Series 430 Bar Stool
Upholstery: Ultra 41574 / Sørensen Leather
Architect: Siv Amundsen
Photo credit: Hydro



PURO
HOTEL
Łódź, Poland

For the amazing art deco inspired *Cinema Paradiso* space at the Puro Hotel in Łódź, Poland, Verpan supplied Series 430 Chairs and Bar Stool.

Photo credit: Anna Stathaki



Upholstery : COM



76

77

Upholstery - COM



Reference: Billund Airport / Billund
 Product: Series 430 Bar Stool
 Upholstery: Prestige 40676 / Sørensens Leather

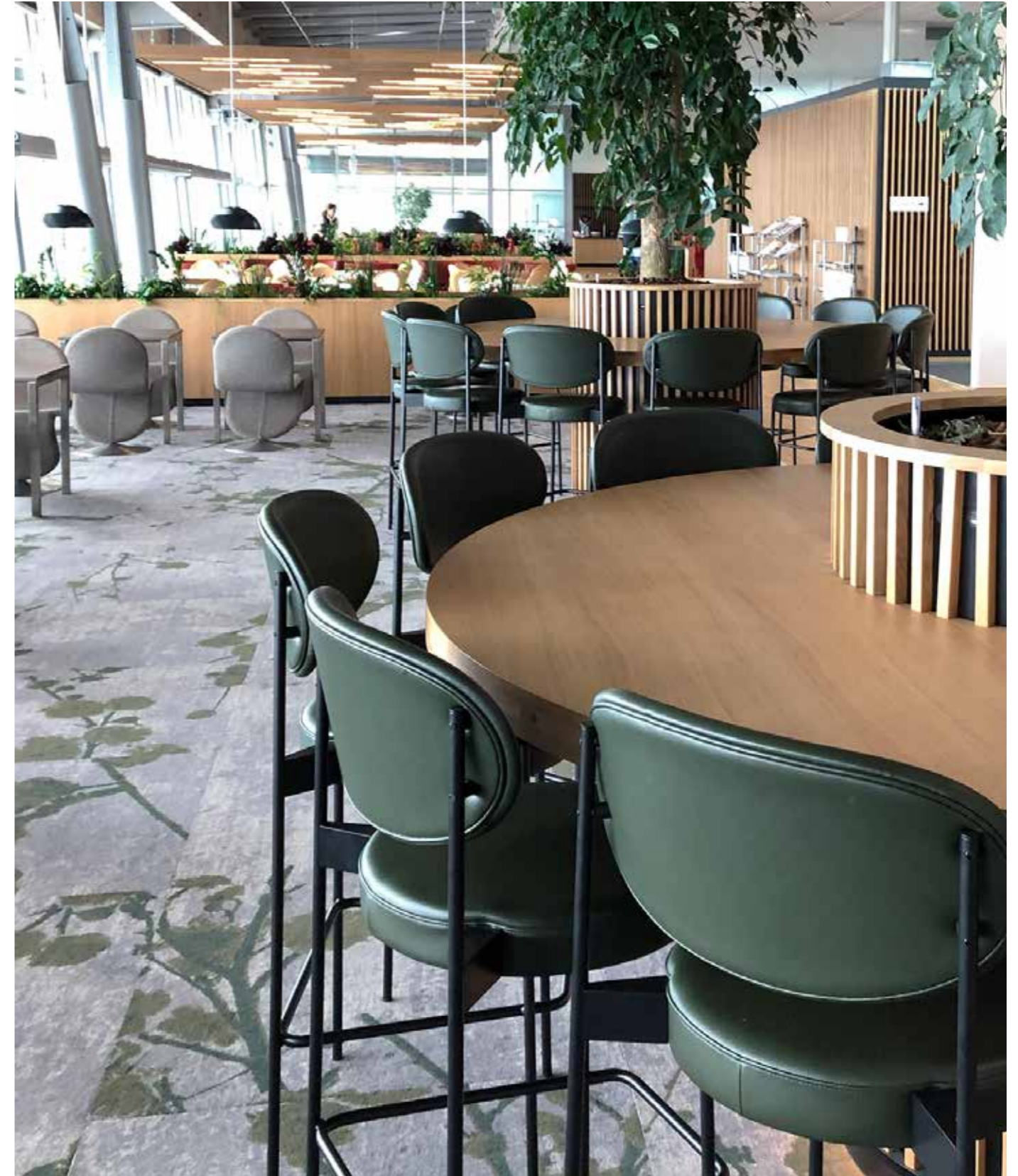

Reference: Billund Airport / Billund
 Product: Series 430 Bar Stool & System 1-2-3 Dining Chair
 Upholstery: Prestige 40676 / Sørensens Leather & Hallingdal 270 / Kvadrat



Reference: Pharos Lighthouse / Hoofddorp
Product: Series 430 Bar Stool
Upholstery: COM
Interior design: Sheryl Leysner
Photo credit: Peter Tijhuis



Reference: Restaurant Sushi Samba / London
Product: Series 430 Bar Stool
Upholstery: Champion 1-3114-055 / JAB
Interior design: Too Many Agencies
Photo credit: Ming Tang Evans

SERIES 430

Stool

by Verner Panton, 1967

WHY WE LOVE IT

Outstanding comfort
Understated elegance
Highly customizable
Super versatile
Fully upholstered

SUGGESTED APPLICATION

Learning
Care
Hospitality
Work
Residential

MATERIAL

FSC-approved wood for seat
Elastic band webbing in the seat
CMHR (CRIB 5) or HR (Cal 117) foam
Painted metal frame (black & white)
Felt feet

DIMENSIONS

Height: 47 cm (18.1")
Seat: Ø46 cm (17.7")
Weight: 4 kg.

STANDARD UPHOLSTERY OPTIONS

Kvadrat
Skai
JAB
Dedar
Sørensen Leather

FRAME OPTIONS

■ Black ■ White

MADE-TO-ORDER OPTIONS

Custom colour painted frame
COM upholstery

DETAILS

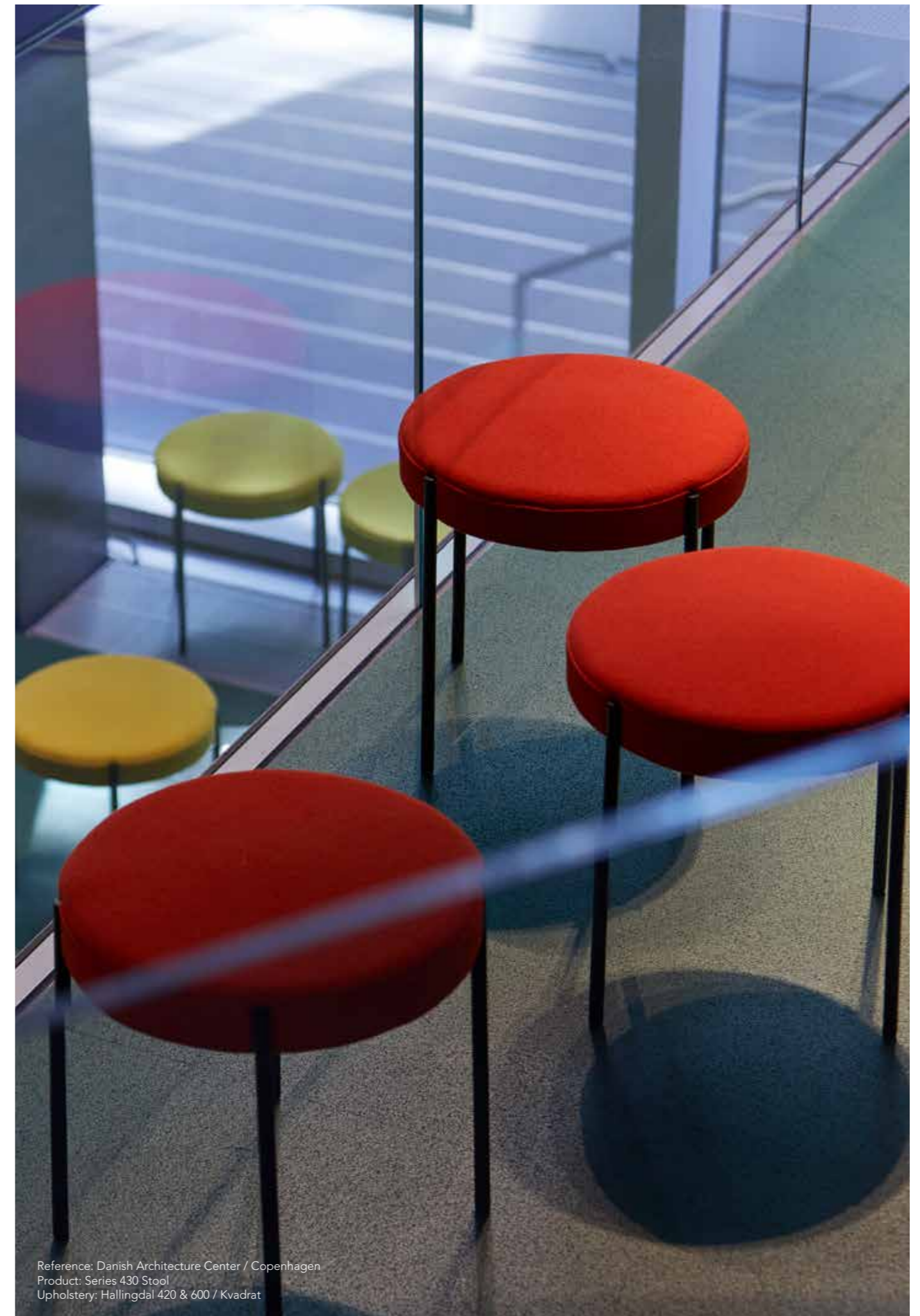
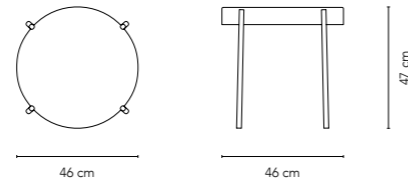

Reference: Danish Architecture Center / Copenhagen
Product: Series 430 Stool
Upholstery: Hallingdal 420 & 600 / Kvadrat

SERIES 430

Table

by Verner Panton, 1967

WHY WE LOVE IT

A perfect match for the Series 430 Chair and Stool
Sleek and elegant design
Available in two sizes
FENIX nanotech on the table top

SUGGESTED APPLICATION

Work
Hospitality
Residential

MATERIAL

Powder coated metal legs
MDF table top with Fenix nanotech laminate
Height adjustable feet

DIMENSIONS

Height: 75 cm (29.5")
Ø120 cm (47.2") / Ø160 cm (63")
Weight: 34 kg / 56 kg

COLOURS

TABLE TOP



Black White

FRAME



Black White

DETAILS

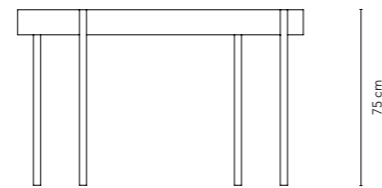

Ø120 cm / Ø160 cm

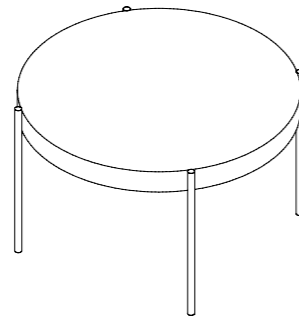

Upholstery: Crystal Field 153 / Kvadrat

MOVE

Table

by Verner Panton, 1972

WHY WE LOVE IT

Super versatile design
Lockable castors for mobility
FENIX nanotech laminate on the table top

SUGGESTED APPLICATION

Learning
Work
Hospitality
Residential

MATERIAL

Frame made of powder coated square steel tube
MDF table top with Fenix nanotech laminate
Mounted with lockable TENTE wheels

DIMENSIONS

Length: 200 cm (78.7")
Width: 95 cm (37.4")
Height: 76,5 cm (30.1")
Weight: 45 kg

COLOURS

TABLE TOP



Black White

FRAME



Black White

DETAILS

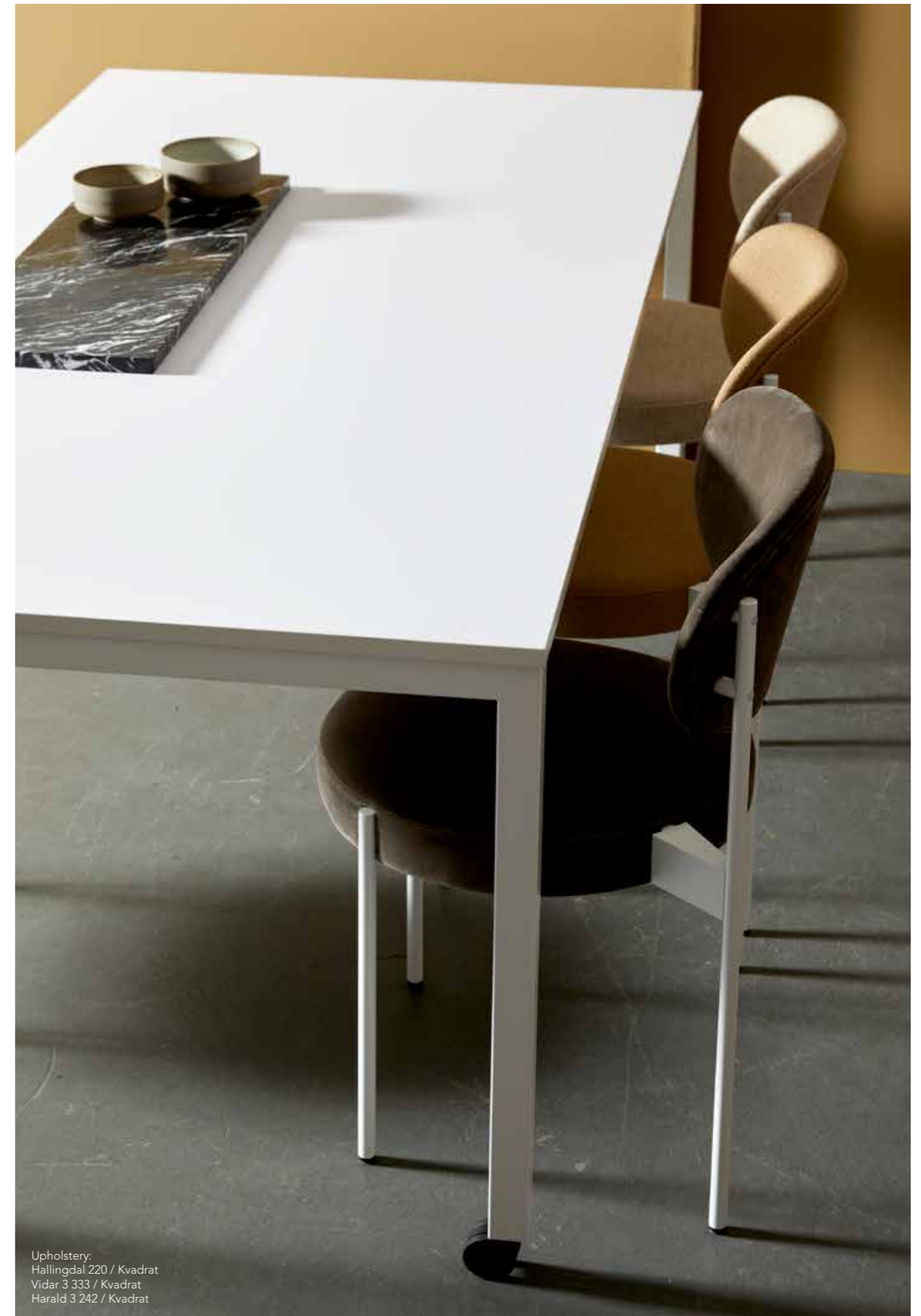
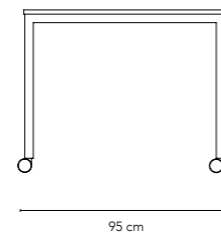
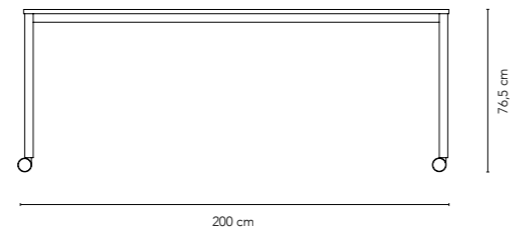

Upholstery:
Hallingdal 220 / Kvadrat
Vidar 3 333 / Kvadrat
Harald 3 242 / Kvadrat

SYSTEM 1-2-3

Dining Chair

by Verner Panton, 1973

WHY WE LOVE IT

Iconic Panton design
Outstanding comfort and great ergonomics
Base swivels for easy access
Fully upholstered
Statement piece

SUGGESTED APPLICATION

Learning
Care
Hospitality
Work
Residential

MATERIAL

Steel frame
VOSS foam
Brushed aluminium base or chrome plated butterfly base
Various upholstery options

DIMENSIONS

H: 86 cm (33.8")
D: 60 cm (23.6")
Seat width: 50 cm (19.6")
Seat depth: 36 cm (14.1")
Seat height front: 47 cm (18.5")
Seat height back: 44 cm (17.3")
Weight: 15 kg.

BASE COLOURS



STANDARD UPHOLSTERY OPTIONS

Kvadrat
Skai
JAB
Dedar
Sørensen Leather

MADE-TO-ORDER OPTIONS

COM upholstery

VARIANTS

BRUSHED ALU BASE

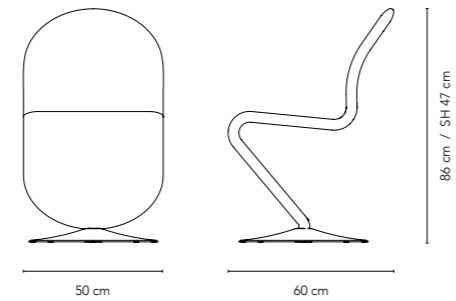

CHROME BUTTERFLY BASE

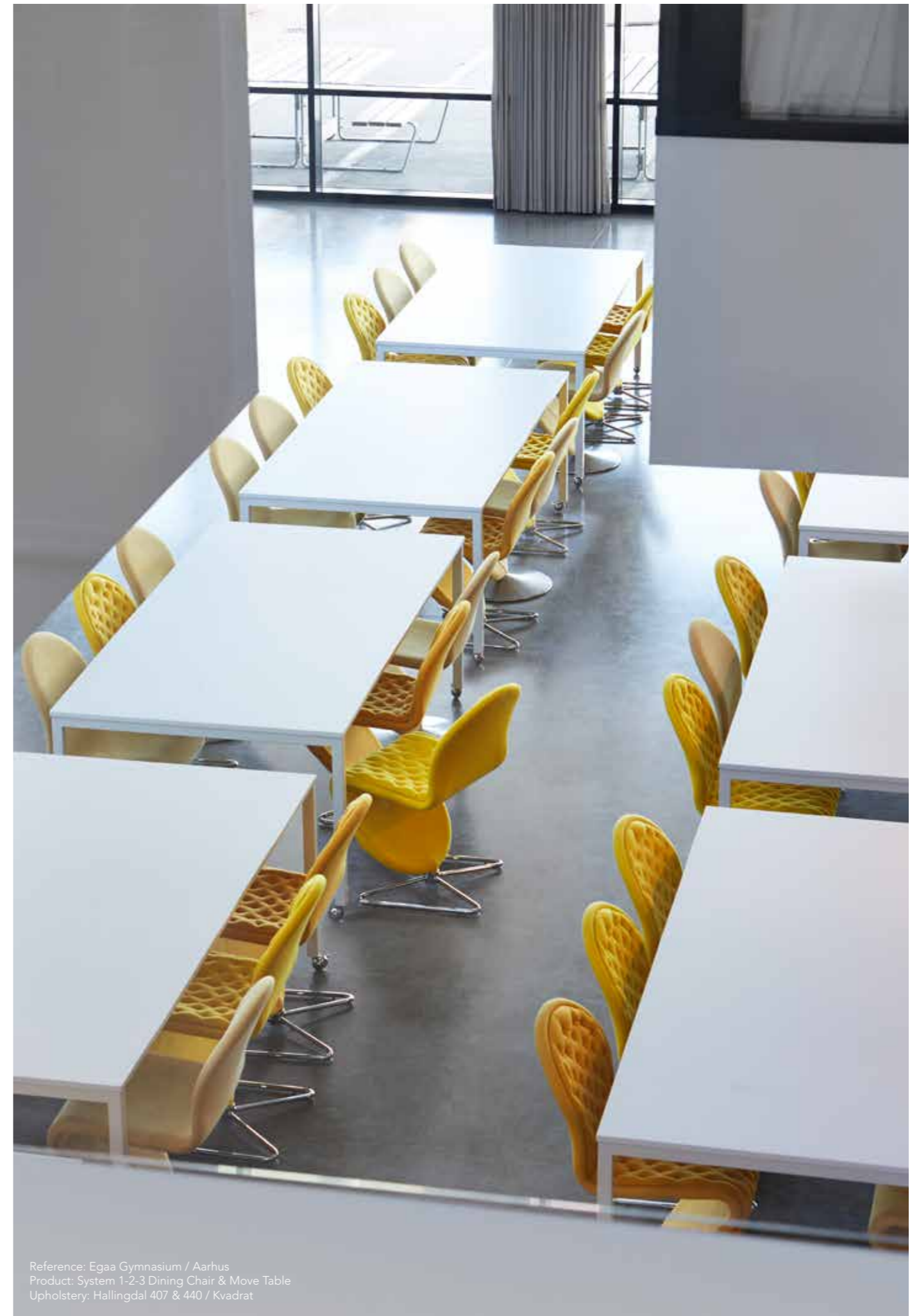
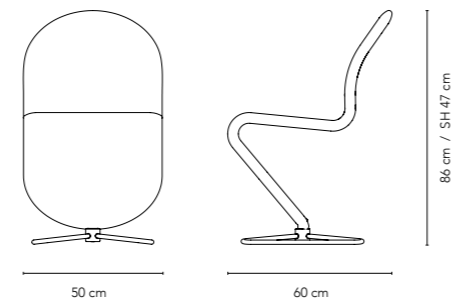

Reference: Egaa Gymnasium / Aarhus
Product: System 1-2-3 Dining Chair & Move Table
Upholstery: Hallingdal 407 & 440 / Kvadrat



EGAA
GYMNASIUM
Aarhus, Denmark

System 1-2-3 Dining Chair displayed at Egaa Gymnasium outside Aarhus, Denmark. The dining chair is used in both the canteen and meeting room settings.



Reference: Egaa Gymnasium / Aarhus
Product: System 1-2-3 Dining Chair & Move Table
Upholstery: Hallingdal 407 & 440 / Kvadrat

AIR PORT

BILLUND AIRPORT

Billund, Denmark

System 1-2-3 Dining Chair for the new King Amlet Lounge in Billund Airport. The project also includes the Series 430 Bar Stool, Cloverleaf sofa and System 1-2-3 Lounge Chair.



SYSTEM 1-2-3

Lounge Chair

by Verner Panton, 1973

WHY WE LOVE IT

Iconic Panton design
Outstanding comfort and great ergonomics
Base swivels for easy access
Fully upholstered
Statement piece

SUGGESTED APPLICATION

Learning
Care
Hospitality
Work
Residential

MATERIAL

Steel frame
VOSS foam
Brushed aluminium base
Various upholstery options

DIMENSIONS

H: 89 cm (35")
D: 82 cm (32.3")
Seat width: 59 cm (23.2")
Seat depth: 45 cm (17.7")
Seat height front: 38 cm (14.9")
Seat height back: 34 cm (13.4")
Weight: 20 kg.

BASE COLOURS



Alu

STANDARD UPHOLSTERY OPTIONS

Kvadrat
Skai
JAB
Dedar
Sørensen Leather

MADE-TO-ORDER OPTIONS

COM upholstery

VARIANTS

BRUSHED ALU BASE

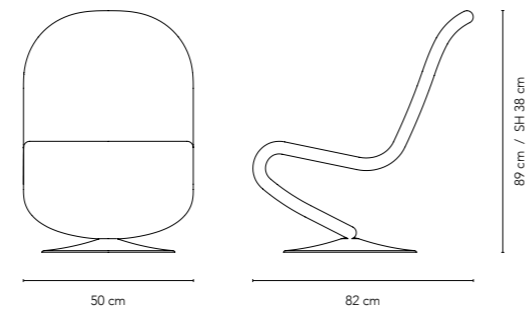

Upholstery: Pilot 792 / Kvadrat



Reference: Egaa Gymnasium / Aarhus
 Product: System 1-2-3 Lounge Chair
 Upholstery: Hallingdal 130 & 407 / Kvadrat

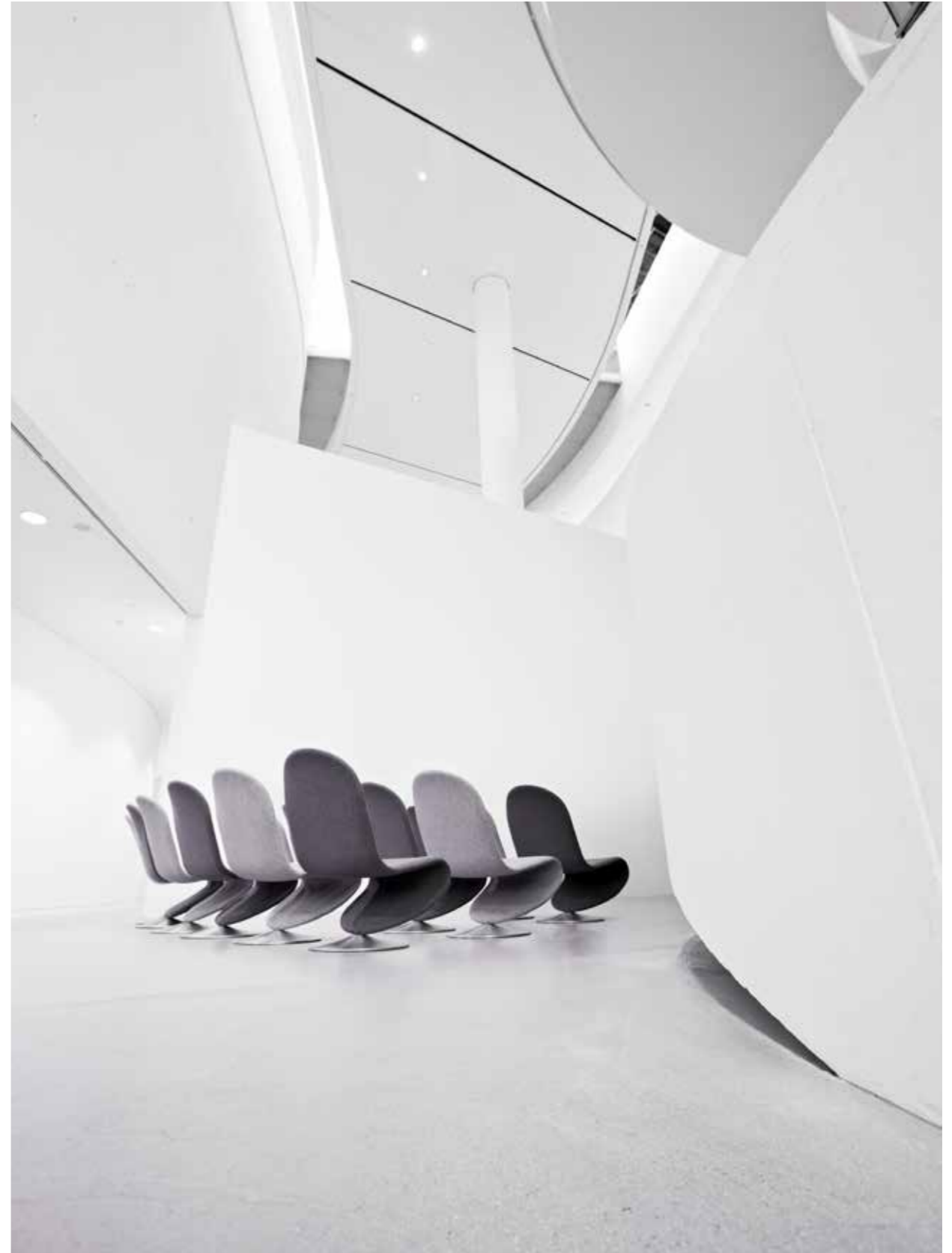

Reference: ARoS Museum of Art / Aarhus
 Product: System 1-2-3 Lounge Chair
 Upholstery: Hallingdal 130 & 180 / Kvadrat

SYSTEM 1-2-3

Rack & Mirror

by Verner Panton, 1973

WHY WE LOVE IT

Stylish wardrobe system
Easy to move
Rotates 360° on its base
The mirror tilts

SUGGESTED APPLICATION

Hospitality
Residential
Work

MATERIAL

Chrome plated steel frame
Chrome plated butterfly base
4mm double sided mirror (MIRROR)

DIMENSIONS

RACK
W: 59 cm (23.2")
H: 169 cm (62.5")
Weight: 10 kg.

MIRROR
W: 59 cm (23.2")
H: 169 cm (62.5")
Weight: 26 kg.

FRAME OPTIONS



Chrome

VARIANTS

RACK

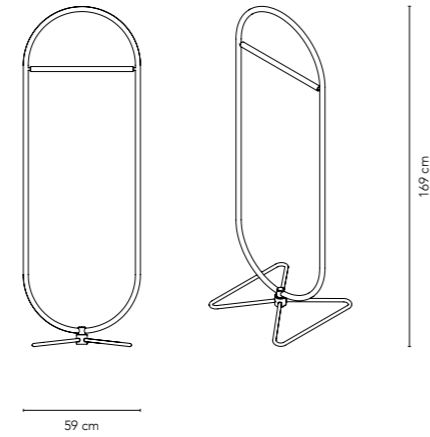

MIRROR

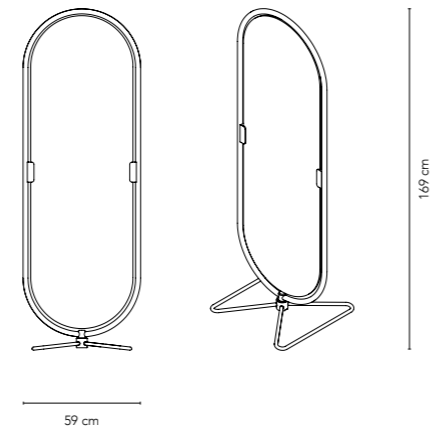

BARBOY

Storage

by Verner Panton, 1963

WHY WE LOVE IT

Mobile side table and storage unit
Fun and functional
Very versatile - works in many settings

SUGGESTED APPLICATION

Hospitality
Work
Residential

MATERIAL

Moulded painted wood
Chrome plated castors

DIMENSIONS

H: 72.5 cm (28.5")
Ø38 cm (15")
Weight: 24 kg.

COLOURS



MADE-TO-ORDER OPTIONS

Available with TENTE castors

DETAILS

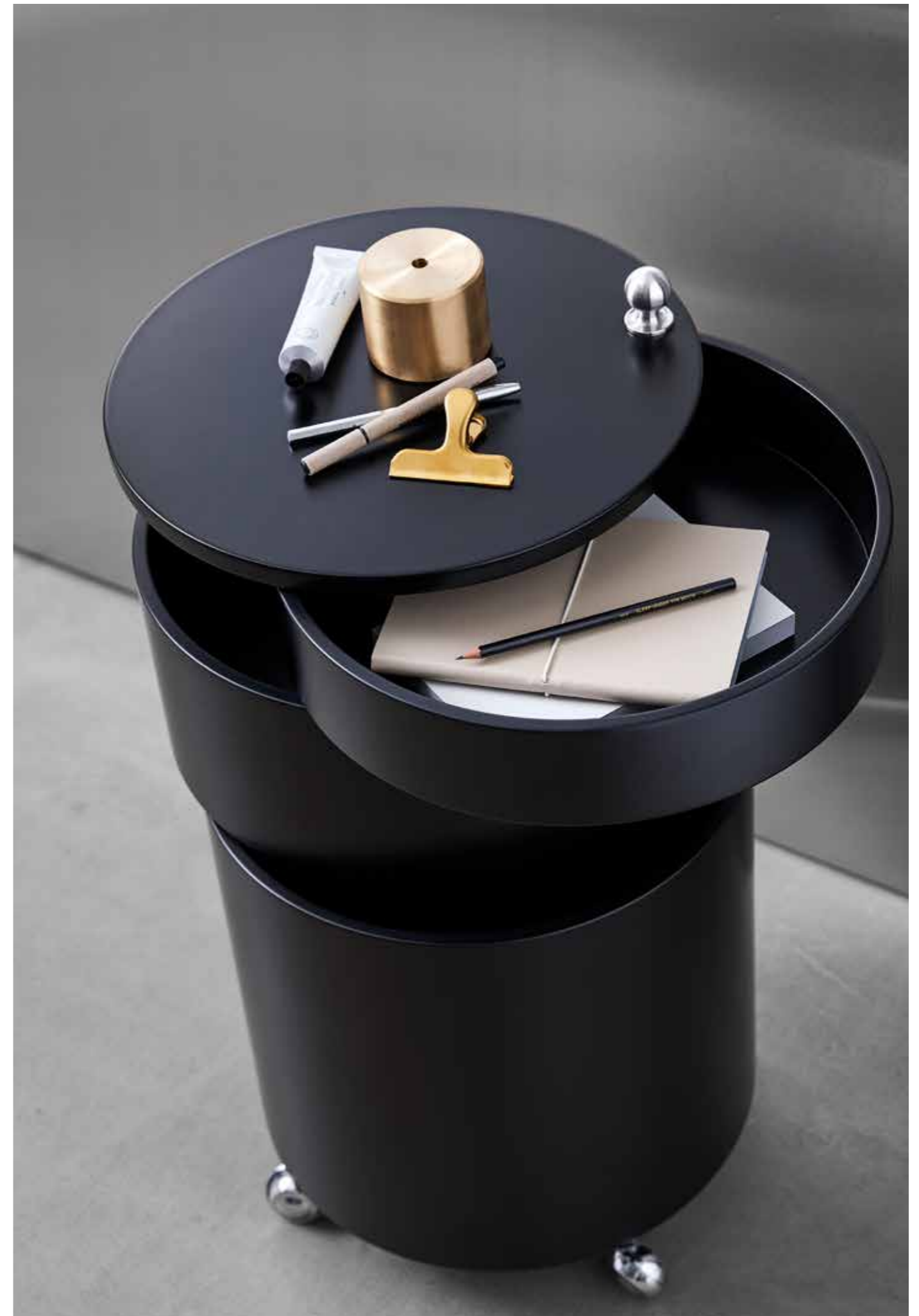
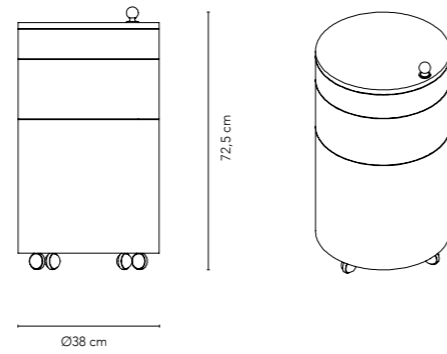



104



105

MIRROR SCULPTURES

Wall Decoration

by Verner Panton, 1963

WHY WE LOVE IT

Reflective wall decoration
Endless configuration options
Creates a very unique and interesting decor

SUGGESTED APPLICATION

Hospitality
Work
Residential

MATERIAL

3 mm (0.1") clear acrylic (PMMA)
Metal wall mounting bracket

DIMENSIONS

W: 48 cm (18.9")
L: 48 cm (18.9")
D: 10 cm (3.9") NINE
D: 14.5 cm (5.7") FOUR
D: 27 cm (10.6") ONE
Weight: 3,3 kg.

COLOUR



Silver/
Mirror

VARIANTS

NINE

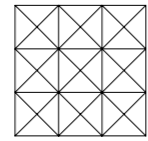

48 cm



10 cm

48 cm

FOUR

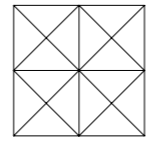

14,5 cm



ONE

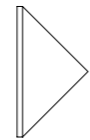
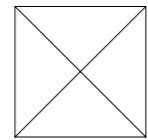

27 cm



Upholstery: Tonus 128 / Kvadrat

WAVE

Rug

by Verner Panton, 1973

WHY WE LOVE IT

Iconic pattern designed by Panton
Hand-tufted quality
Available in three colours
Care & Fair certified

SUGGESTED APPLICATION

Hospitality
Work
Residential

MATERIAL

100% New Zealand wool

DIMENSIONS

L: 240 cm (94.5")
W: 170 cm (66.9")
Weight: 21 kg.

VARIANTS

GREY

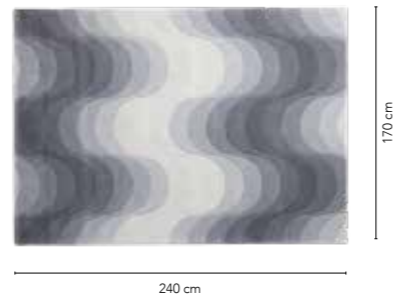

ORANGE



YELLOW



Upholstery: Harald 3 543 / Kvadrat

LUNA

Rug

by Verner Panton, 1979

WHY WE LOVE IT

Iconic pattern designed by Panton
Hand-tufted quality
Available in three colours
Care & Fair certified

SUGGESTED APPLICATION

Hospitality
Work
Residential

MATERIAL

100% New Zealand wool

DIMENSIONS

Ø 120 cm (47.2")
Weight: 6.5 kg.

VARIANTS

DARK YELLOW



Ø120 cm

GREY



DARK GREEN



GRANDE

Rug

by Verner Panton, 1965

WHY WE LOVE IT

Iconic pattern designed by Panton
Hand-tufted quality
Available in two colours
Care & Fair certified

SUGGESTED APPLICATION

Hospitality
Work
Residential

MATERIAL

100% New Zealand wool

DIMENSIONS

Ø 220 cm (86.6")
Weight: 22 kg.

VARIANTS

YELLOW



Ø220 cm

GREY

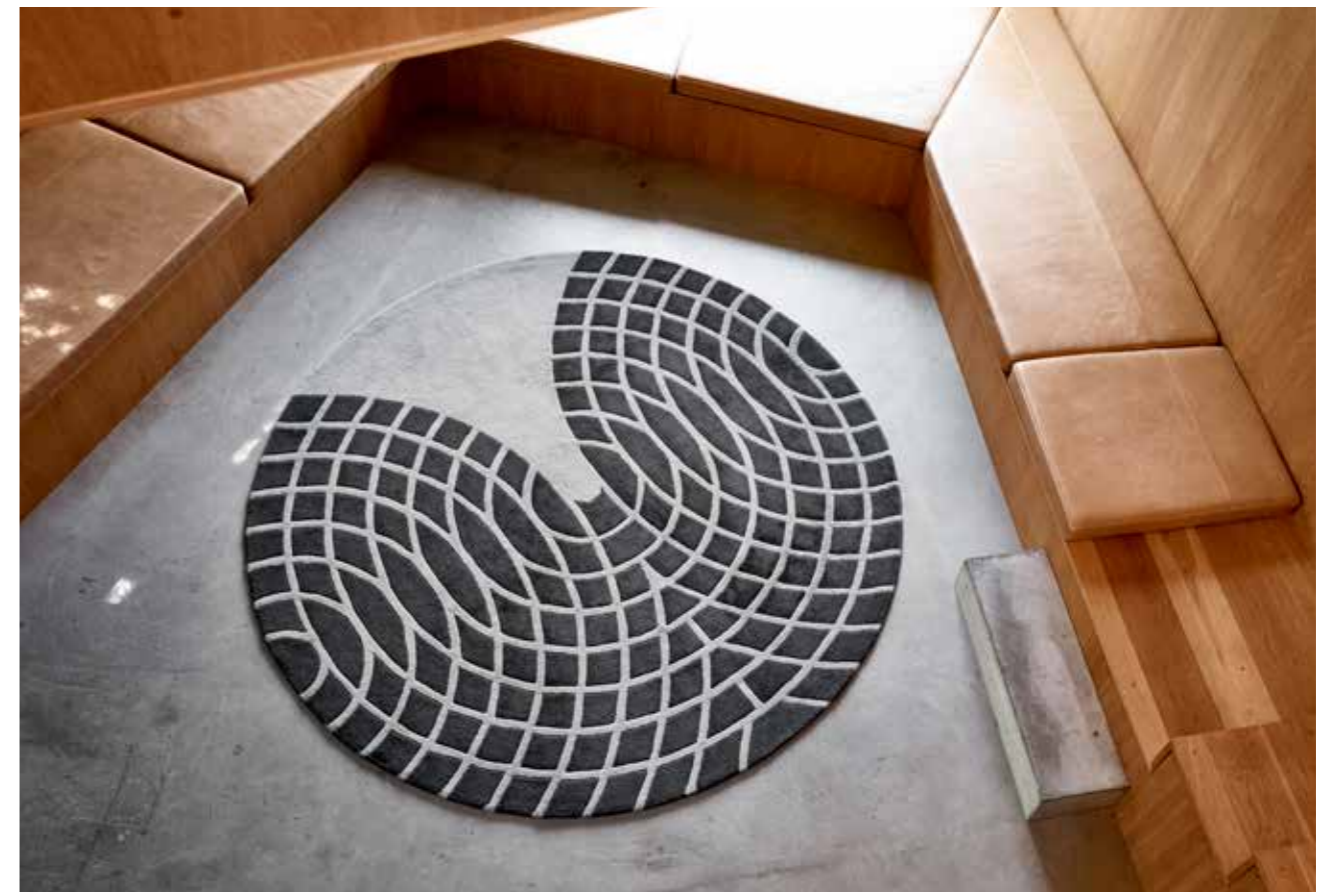

MIRROR

Throw

by Verner Panton, 1969

WHY WE LOVE IT

100% New Zealand wool
Iconic pattern designed by Panton
Great way to easily add some interest to a decor
Available in four colours

SUGGESTED APPLICATION

Care
Hospitality
Residential

MATERIAL

100% New Zealand wool

DIMENSIONS

L: 198 cm (78")
W: 130 cm (51")
Weight: 1 kg.

VARIANTS

BLACK

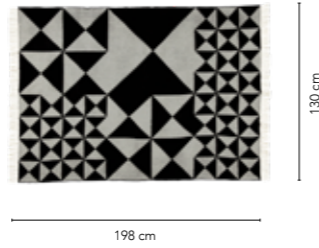

ORANGE



YELLOW



BLUE

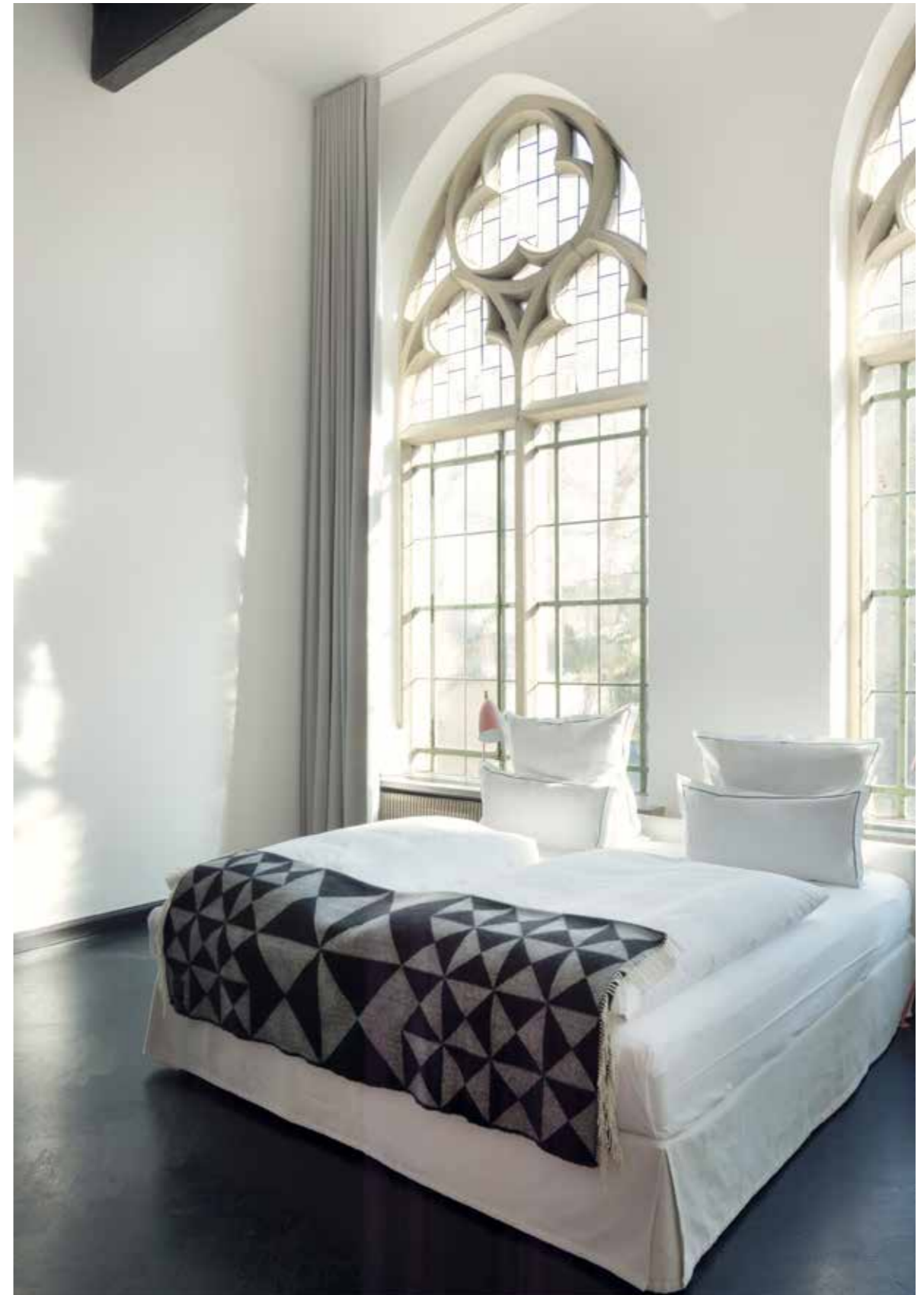

Reference: The Quest Hotel / Cologne
Product: Mirror Throw

POLETTE

Throw

by Verner Panton, 1965

WHY WE LOVE IT

100% Alpaca wool
 Iconic pattern designed by Panton
 Great way to easily add some interest to a decor
 Available in two colours

SUGGESTED APPLICATION

Care
 Hospitality
 Residential

MATERIAL

100% Alpaca wool

DIMENSIONS

L: 175 cm (69")
 W: 135 cm (53")
 Weight: 1 kg.

VARIANTS

BURGUNDY



175 cm

135 cm

BEIGE



Upholstery: Hallingdal 180 / Kvadrat
 Ceramic: Bjarni Viðar Sigurðsson

UPHOLSTERY PROGRAM



The Verpan Upholstery Program is an overview of textile and leather available for the Verpan upholstered furniture. The listed fabrics and leathers are available in all colours.

In addition to the options listed, we have tested several other fabrics and entered trade agreements with a number of other suppliers, which enables us to answer most customer needs. We are also happy to upholster furniture using customer's own materials (COM) with extended lead times.

For special requests, please contact our sales team.

Fabric	System 123 Standard	System 123 Deluxe	Series 430	Cloverleaf Sofa	Welle	Flying Chair	VP 168 Sofa	US Cal. Bull. 117-2013	BS 5852 Part 1 (cigarette & match)
COM/COL									
Kvadrat Messenger*	•	•	•	•	•	•	()	Yes	(Yes)
Kvadrat Metric*	•	•	•	•	•	•	()	Yes	(Yes)
Kvadrat Atlas			•	•	•	()	•	Yes	Yes ¹
Skai Parotega		•	•	•	•	()	()		Yes
Kvadrat Melange Nap	•	•	•	•	•	•	•	Yes	Yes ¹
Kvadrat Hallingdal	•	•	•	•	•	•	•	Yes	Yes + BS 5852 Crib 5
Kvadrat Tonus	•	•	•	•	•	•	•	Yes	Yes ¹
Kvadrat Steelcut Trio	•	•	•	•	•	()	()	Yes	Yes ¹
Kvadrat Merit	•	•	•	•	•	()	•	Yes	(Yes)
JAB Champion			•		•	()	•	Yes	Yes + BS 5852 Crib 5
JAB Sweet Lovin	()	()	•	•	()	()	()	Yes	(Yes)
Spradling Patriot Plus	•	•	•	•	•	•	•	Yes	
Kvadrat Harald		•	•	•		•	•		
Sacho Cuba		•	•		()	()	()	?	(Yes)
Kvadrat Vidar	•	•	•	•	•	•	•	Yes	Yes ¹
Kvadrat Divina 3, MD, Melange	•	•	•	•	•	•	•	Yes	V + BS 5852 Crib 5
Kvadrat Steelcut	•	•	•	•	•	()	()	Yes	Yes ¹
Dedar Ademo&Eva	()	()	•	•	()	()	•		(Yes)
Dedar Karakorum	•	•	•	•	•	()			Yes + BS 5852 Crib 5
Dedar Twist Again	()	()	•	()	()	()	()		(Yes)
Dedar Atlas	()	()	•	()	()	•	()		Yes + BS 5852 Crib 5
Kvadrat Waterborn	()	()	•	()		•	()	Yes	(Yes)
Kvadrat Phlox		•	•						(Yes)
Kvadrat Pilot	•		•	()				Yes	Yes ¹
Kvadrat Byram	()	()	•	•	()	()	()	Yes	Yes + BS 5852 Crib 5
Sørensen Ultra	•	•	•	•	•	()	()	Yes	Yes
Sørensen Hero	•	•	•	•	()	()	()		BS EN 1021-1 and 2
Sørensen Shade	•	•	•	()	()	()	()	Yes	

*selected colours - other colours are available in other price groups

() = not tested for the specific model - test can be performed on request

(Yes) = Treatment is needed - after BS 5852 Part 1 + Crib 5 treatment is fulfilled

Yes¹ = BS 5852 Part 1 is fulfilled - needs treatment to fulfill BS 5852 Crib 5

LIGHTNING

FUN Pendants

by Verner Panton, 1964

WHY WE LOVE IT

Iconic design with a great story
Glamorous and elegant design that interacts with its surroundings
Generous light output
Combines light, movement and sound
Available in a number of sizes and materials

SUGGESTED APPLICATION

Hospitality
Work
Residential

MATERIAL

Seashell (DM) or polished stainless steel (DA) discs
Chrome plated metal frame (silver or brass)
Stainless steel rings
Black fabric cord

DIMENSIONS

122 FUN 2DM/DA
Height: 43 cm (16.9")
Ø: 27 cm (10.6")
Weight: 3,0 kg.

FUN 10DM
Height: 38 cm (14.9")
Ø: 57 cm (22.4")
Weight: 7,0 kg.

FUN 1DM/DA
Height: 60 cm (17.7")
Ø: 45 cm (23.6")
Weight: 5,0 kg.

FUN 11DM
Height: 44 cm (17.30")
Ø: 70 cm (27.6")
Weight: 6,5 kg.

FUN 0DM/DA
Height: 76 cm (31.0")
Ø: 53 cm (21.6")
Weight: 6,5 kg.

FRAME OPTIONS



Steel Brass

Brass frame is available for 10DM and 11DM only.

DISC OPTIONS



Seashell Steel

Steel discs are not available for 10DM and 11DM.

VARIANTS

FUN 2DM/DA

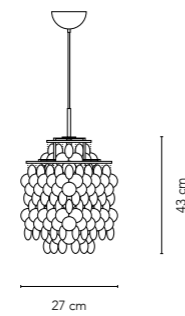

FUN 1DM/DA

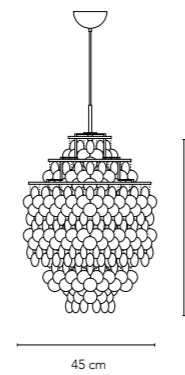

FUN 0DM/DA

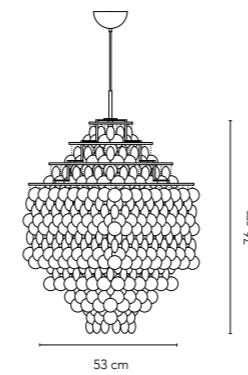

FUN 10DM

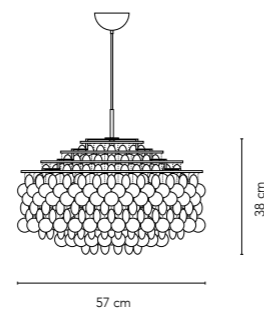

FUN 11DM

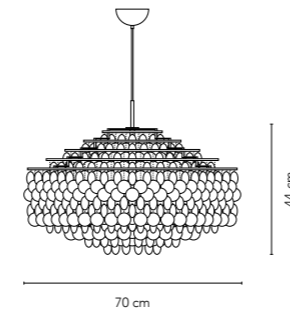



125

MOTEL ONE ROSTOCK

Rostock, Germany

For its reception and restaurant area, Motel One in Rostock decided to go with a selection of Panton's FUN pendants and even requested a custom installation of the seashells.

The selection features the impressive FUN 8DM and a number of FUN 2DM and FUN 1DM pendants.

Photo credit: Motel One





Upholstery: Tonus 128 / Kvadrat

FUN

Table Lamps

by Verner Panton, 1964

WHY WE LOVE IT

Iconic design with a great story
 Glamorous and elegant design that interacts with its surroundings
 Generous light output
 Combines light, movement and sound
 Attractive sizes with many application options

SUGGESTED APPLICATION

Hospitality
 Work
 Residential

MATERIAL

Seashell (TM) or polished stainless steel (TA) discs
 Chrome plated metal frame (silver or brass)
 Stainless steel rings
 Black fabric cord

DIMENSIONS

128 FUN 2TM/TA	FUN 1TM/TA
Height: 43 cm (16.9")	Height: 65 cm (25.6")
Ø: 27 cm (10.6")	Ø: 40 cm (15.8")
Weight: 3,0 kg.	Weight: 8,0 kg.

FRAME OPTIONS



Brass frame is available for 2TM only.

DISC OPTIONS



VARIANTS

FUN 2TM/TA

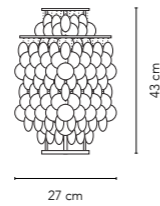

FUN 1TM/TA

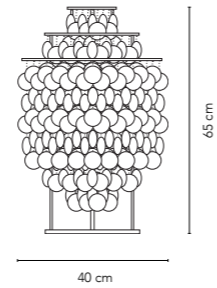

FUN Wall

by Verner Panton, 1964

WHY WE LOVE IT

Iconic design with a great story
Glamorous and elegant design that interacts with its surroundings
Generous light output
Combines light, movement and sound
Available in a number of sizes and materials

SUGGESTED APPLICATION

Hospitality
Work
Residential

MATERIAL

Seashell (DM) or polished stainless steel (DA) discs
Chrome plated metal frame
Stainless steel rings

DIMENSIONS

FUN 1WM/1WA
H: 58 cm (22.8")
D: 22 cm (8.7")
W: 40 cm (15.7")
Weight: 4 kg.

FRAME OPTIONS



Steel

DISC OPTIONS



Seashell



Steel

VARIANTS

FUN 1WM/1WA

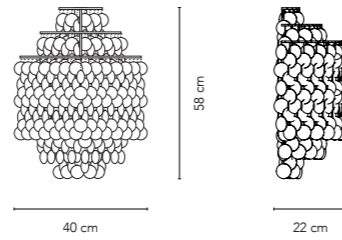

Reference: Restaurant La Fonda, Cologne
Product: FUN 1WM
Photo credit: Jo Fober



FUN Floor

by Verner Panton, 1964

WHY WE LOVE IT

Iconic design with a great story
Glamorous and elegant design that interacts with its surroundings
Generous light output
Combines light, movement and sound
Available in a number of sizes and materials

SUGGESTED APPLICATION

Hospitality
Work
Residential

MATERIAL

Seashell (DM) or polished stainless steel (DA) discs
Chrome plated metal frame (silver or brass)
Stainless steel rings

DIMENSIONS

FUN 1STM
H: 120 cm (47.2")
Ø40 cm (15.8")
Weight: 10 kg.

FRAME OPTIONS



Steel Brass

DISC OPTIONS



Seashell

VARIANTS

FUN 1STM

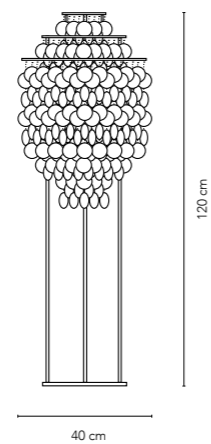

FUN

XL Pendants

by Verner Panton, 1964

WHY WE LOVE IT

Iconic design with a great story
Glamorous and elegant design that interacts with its surroundings
Generous light output
Combines light, movement and sound
Large pieces that can really elevate a decor

SUGGESTED APPLICATION

Hospitality
Work
Residential

MATERIAL

Seashell discs
Stainless steel rings
Ceiling plate is made of MDF (white lacquered).
Transparent plastic cord.

DIMENSIONS

134 FUN 4DM
Height: 110 cm (43.3")
Ø: 56 cm (22.1")
Weight: 14 kg.

FUN 3DM
Height: 240 cm (94.4")
Ø: 56 cm (22.1")
Weight: 21 kg.

FUN 5DM
Height: 180 cm (70.9")
Ø: 56 cm (22.1")
Weight: 19 kg.

CANOPY COLOUR

White

DISC OPTIONS

Seashell

VARIANTS

FUN 4DM

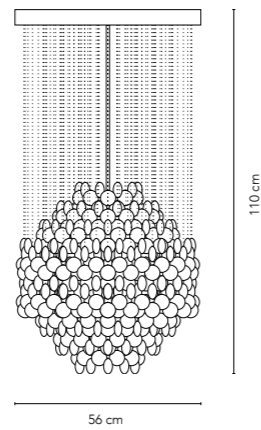

FUN 3DM

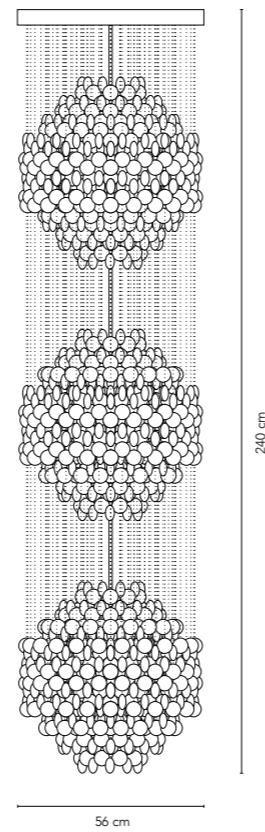

FUN 5DM

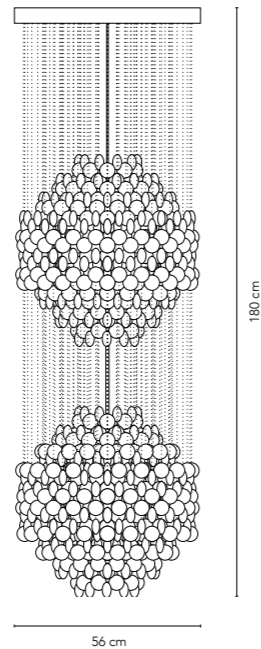

Upholstery: Vidar 182 / Kvadrat

FUN

XL Pendants

by Verner Panton, 1964

WHY WE LOVE IT

Iconic design with a great story
Glamorous and elegant design that interacts with its surroundings
Generous light output
Combines light, movement and sound
Large pieces that can really elevate a decor

SUGGESTED APPLICATION

Hospitality
Work
Residential

MATERIAL

Seashell discs
Stainless steel rings
Ceiling plate is made of MDF (white lacquered).
Transparent plastic cord.

DIMENSIONS

136 FUN 7DM
Height: 110 cm (43.3")
Ø: 100 cm (39.4")
Weight: 30 kg.

FUN 8DM
Height: 200 cm (78.9")
Ø: 100 cm (39.4")
Weight: 45 kg.

CANOPY COLOUR



White

DISC OPTIONS



Seashell

VARIANTS

FUN 7DM

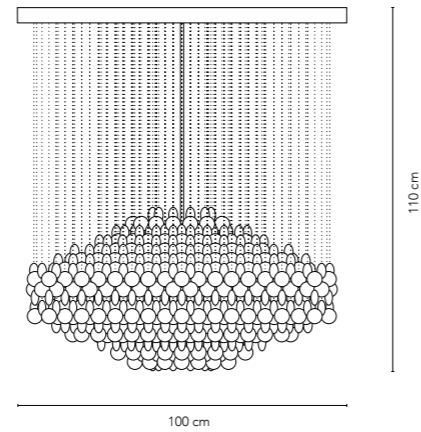

FUN 8DM

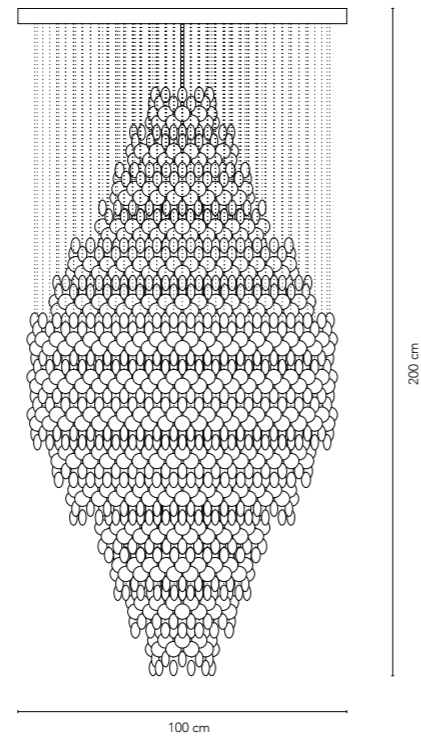

RESTAURANT

CAFÉ STIFTEN

Aarhus, Denmark

Café Stiften is located in the heart of Aarhus and serves a large and diverse crowd from breakfast to late night drinks. The atmosphere is rugged with exposed brick walls and large windows facing the busy street outside.

As a soft counter to the brick walls and glass, Pantón's FUN pendants illuminate the space in cascades of soft ambient light creating a cozy urban atmosphere.



VP GLOBE

Pendant

by Verner Panton, 1969

WHY WE LOVE IT

Arguably the most recognized Panton lighting design
Futuristic and sculptural design that interacts with its surroundings
The different executions of the design allows for different expressions
Decorative mood setting light output

SUGGESTED APPLICATION

Hospitality
Work
Residential

MATERIAL

Acrylic outer top and bottom shell
Reflectors are suspended in steel chains
Canopy made from chrome plated metal

Reflector material:
VP Globe - polished aluminium
VP Globe Brass Finish - brass plated aluminium
VP Globe Glass - opal glass
VP Globe Coloured Glass - coloured glass & polished aluminium

DIMENSIONS

VP GLOBE
Ø: 40 cm (15.8") / Ø50 (19.7")
Weight: 5 kg / 9 kg.

VP GLOBE Brass Finish
Ø: 40 cm (15.8")
Weight: 5 kg

VP GLOBE Glass
Ø: 40 cm (15.8") / Ø50 (19.7")
Weight: 5 kg / 9 kg.

VP GLOBE Coloured Glass
Ø: 40 cm (15.8")
Weight: 5 kg

COLOURS

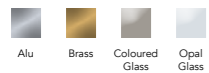

VARIANTS

VP GLOBE ø40

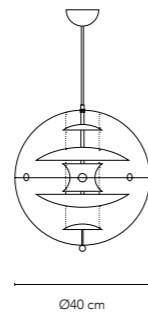

VP GLOBE ø50

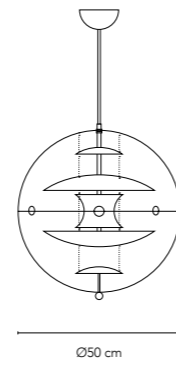

Vit Globe



142

143

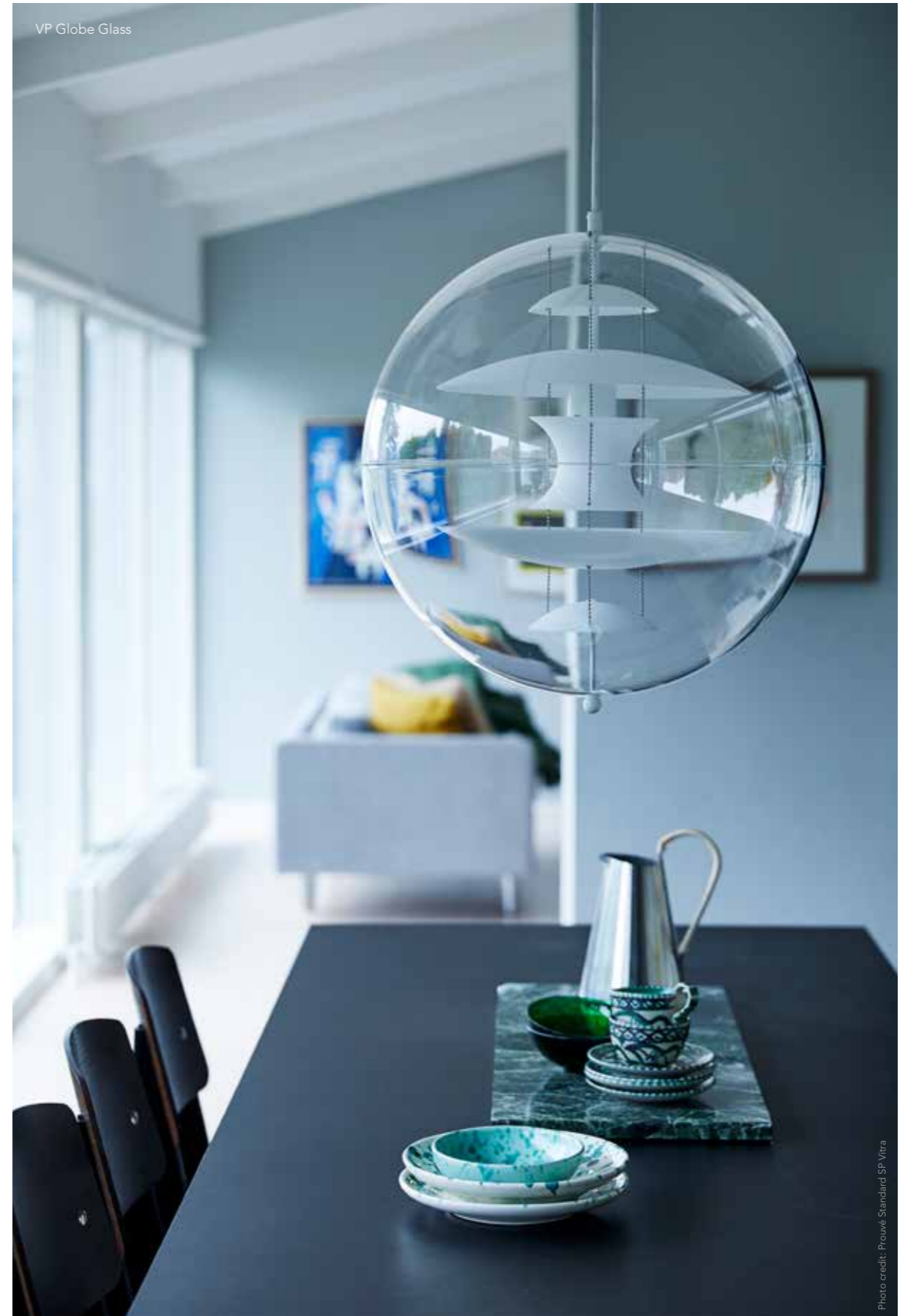

VP Globe Brass Finish



VP Globe Coloured Glass



RES TAU RANT

CAFÉ
JEOKDANG
Seoul, Korea

A number of Pantón's VP Globe pendants suspended above the beautiful massive wood tables in the Jeokdang Café in Seoul.

Photo credit: Café Jeokdang



Reference: Restaurant L'Arc/ Paris
Product: VP Globe



PANTO

Pendant

by Verner Panton, 1977

WHY WE LOVE IT

Classic variation of the iconic VP Globe design
Futuristic and sculptural design that interacts with its surroundings
Decorative mood setting light output

SUGGESTED APPLICATION

Hospitality
Work
Residential

MATERIAL

Acrylic outer top and bottom shell
Reflectors made from lacquered aluminium
Reflectors are suspended in steel chains
Canopy made from lacquered metal

DIMENSIONS

PANTO
Ø: 40 cm (15.8") / Ø50 (19.7")
Weight: 5 kg / 10 kg.

VARIANTS

PANTO ø40

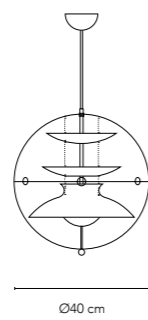

PANTO ø50

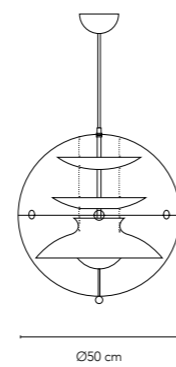

Reference: Briig Boutique Hotel, Split
Product: Panto Pendant
Architect: Maja Tedeschi
Photo credit: Nord Klassik



HIVE

Pendant

by Verner Panton, 1977

WHY WE LOVE IT

Generous downward light and a soft and diffused lateral light
Layered shades concealing the light source
Very characteristic and sculptural quality

SUGGESTED APPLICATION

Hospitality
Work
Residential

MATERIAL

Aluminium shades
Polished aluminium (alu) or powder coated finish (yellow)
Ceiling canopy in same colour/finish as lamp.

DIMENSIONS

Ø: 48 cm (19")
Weight: 3,7 kg

COLOURS

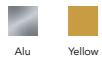

Alu Yellow

VARIANTS

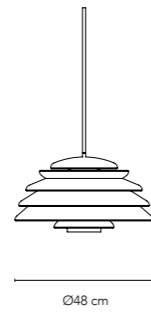



SPIEGEL

Wall & Ceiling

by Verner Panton, 1969

WHY WE LOVE IT

Architectural and sculptural lighting art piece
Great attention piece
Stunning single-piece statement or dramatic large-scale installation
For wall or ceiling mounting
Ambient lighting with zero glare

SUGGESTED APPLICATION

Hospitality
Work
Residential

MATERIAL

Made from welded steel
Painted silver finish

DIMENSIONS

W: 62,5 cm (24.6")
H: 62,5 cm (24.6")
D: 20 cm (7.9")
Weight: 5,4 kg.

COLOURS



Silver

VARIANTS

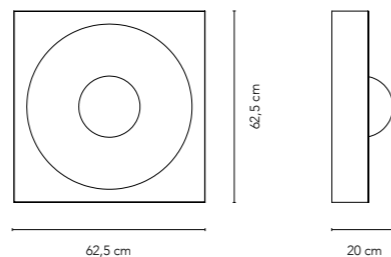

Reference: Artilleriet Store / Göteborg
Product: Spiegel
Photo credit: Artilleriet





Upholstery:
Royal Nubuck Lava 30254 / Sørensen Leather
Hallingdal 180 / Kvadrat
Harald 3 343 / Kvadrat

Ceramic: Lars Rank Keramik

BALL Pendant

by Verner Panton, 1969

WHY WE LOVE IT

Fun & Futuristic
Reflects the light and colours of its surroundings
Generous light output

SUGGESTED APPLICATION

Hospitality
Work
Residential

MATERIAL

Chromed balls made of plastic (PS MIX 475)
Ceiling canopy and frame is made from chrome plated metal

DIMENSIONS

H: 45 cm (17,5")
Ø44 cm (17.3")
Weight: 6,5 kg.

FRAME OPTIONS



Steel

COLOURS



Silver

VARIANTS

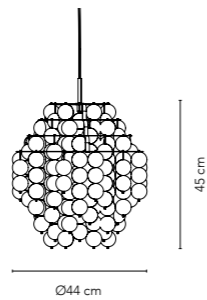

Reference: Artilleriet Store, Göteborg
Product: Ball Pendant & Wire Table Lamp
Photo credit: Artilleriet



SPIRAL

Pendants

by Verner Panton, 1969

WHY WE LOVE IT

Iconic design with a great story
 Playful design that interacts with its surroundings
 Generous light output
 Combines light, movement and sound
 Available in a number of sizes and materials

SUGGESTED APPLICATION

Hospitality
 Work
 Residential

MATERIAL

Cast ABS plastic
 Nylon string
 Ceiling canopy is made from cast ABS plastic
 Transparent plastic cord

DIMENSIONS

MINI
 Height: 55 cm (21.7")
 Ø: 34 cm (13.4")
 Weight: 5 kg.

SP01
 Height: 60 cm (23.6")
 Ø: 45 cm (17.7")
 Weight: 7 kg.

FRAME OPTIONS



Steel Gold

SPIRAL COLOURS



Gold Silver Multi

Spiral Mini is only available in silver.

VARIANTS

MINI

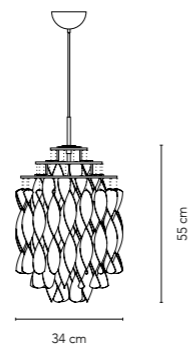

SP01

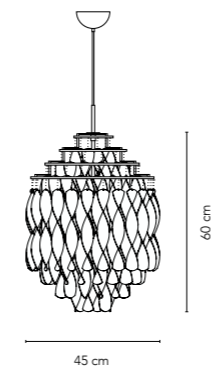

Upholstery: Harald 3 182 / Kvadrat

Photo credit: Stool 60 Arek





SPIRAL

XL Pendants

by Verner Panton, 1969

WHY WE LOVE IT

Iconic design with a great story
 Playful design that interacts with its surroundings
 Ambient light output
 Combines light, movement and reflections
 Large pieces that can really elevate a decor

SUGGESTED APPLICATION

Hospitality
 Work
 Residential

MATERIAL

Cast ABS plastic
 Nylon string
 Ceiling canopy is made from cast ABS plastic
 Transparent plastic cord

DIMENSIONS

172 SPIRAL SP1
 H: 115 cm (45.3")
 Ø48 cm (18.9")
 Weight: 11 kg.

SPIRAL SP3
 H: 220 cm (86.6")
 Ø48 cm (18.9")
 Weight: 17 kg.

SPIRAL SP2
 H: 180 cm (70.9")
 Ø48 cm (18.9")
 Weight: 14 kg.

CANOPY COLOURS



Steel Gold White

SPIRAL COLOURS



Gold Silver Multi

VARIANTS

SP1

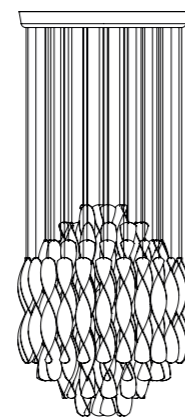

48 cm

115 cm

SP3

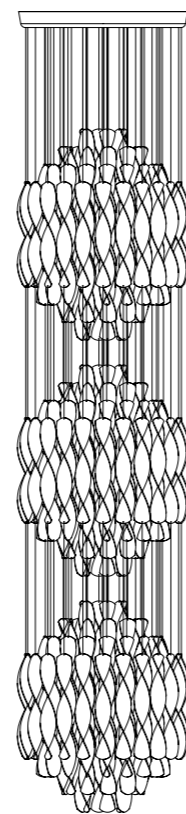

48 cm

220 cm

SP2

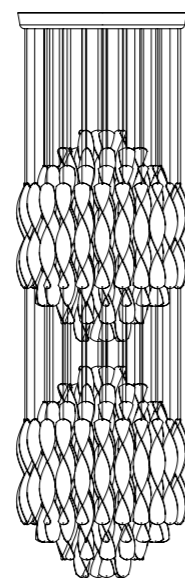

48 cm

180 cm

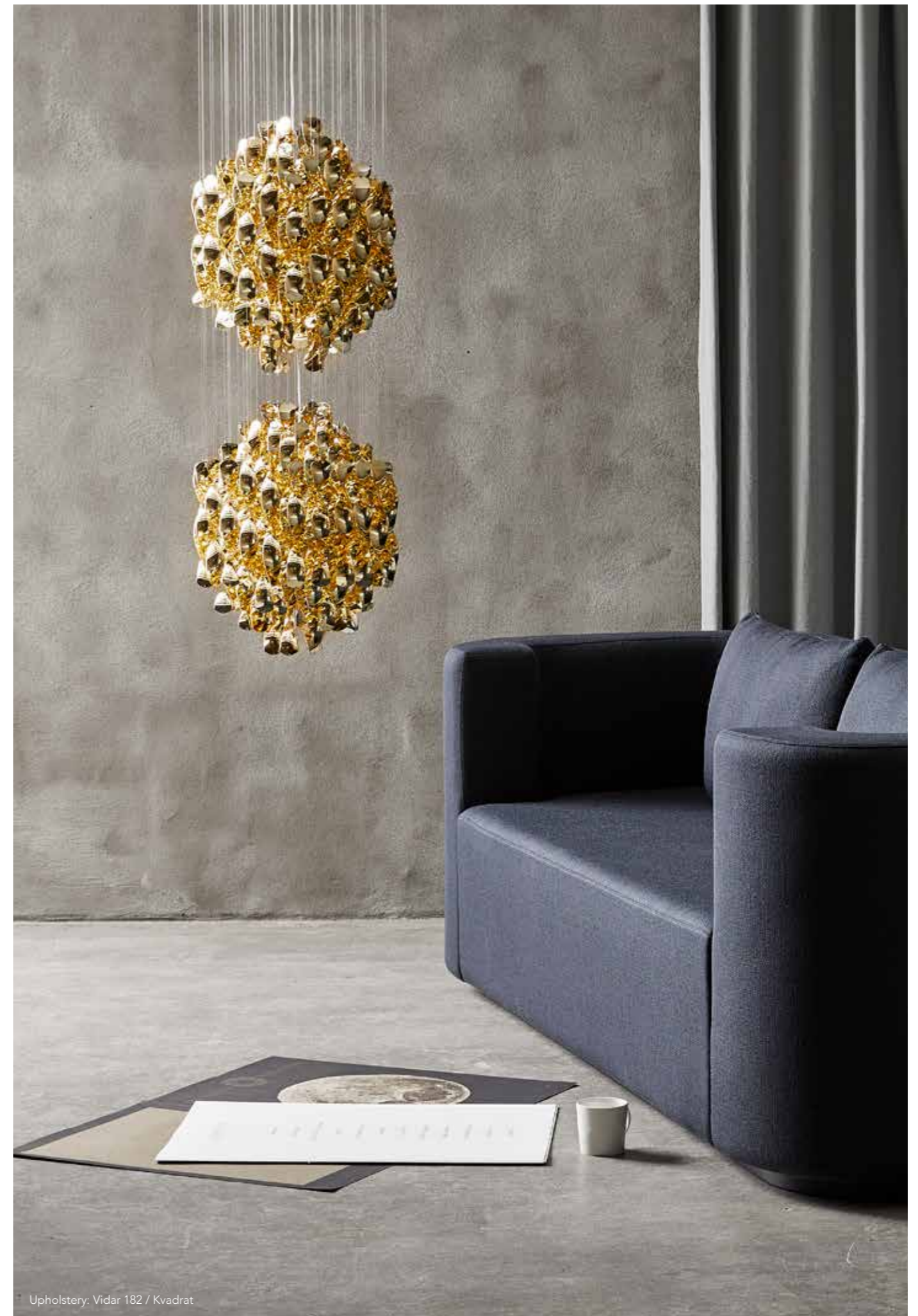

Upholstery: Vidar 182 / Kvadrat

Reference: Horsens New Theatre, Horsens
Product: Spiral SP01, SP2, SP3 & Ball Pendants
Architect: Christian Fogh



174

175

PANTOP

Series

by Verner Panton, 1980

WHY WE LOVE IT

Classic bell design with decorative and functional light
Complete family with great versatility
Great size and beautiful finishes
Perfect for series installation

SUGGESTED APPLICATION

Hospitality
Work
Residential

MATERIAL

All parts are made from metal
Powder coated finish on black and grey versions
Brass plating for the antique brass version

DIMENSIONS

PENDANT
Height: 25 cm (9.8")
Ø45 cm (17.7")
Weight: 1,4 kg.

TABLE LAMP
H: 65,5 cm (25.8")
Ø45 cm (17.7")
Weight: 4,2 kg.

FLOOR LAMP
Height: 132,5 cm (52")
Ø45 cm (17.7")
Weight: 7,7 kg.

SHADE OPTIONS

PENDANT



TABLE LAMP



FLOOR LAMP



VARIANTS

PENDANT

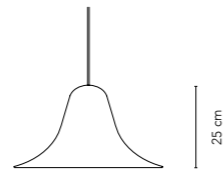

Ø45 cm

TABLE LAMP

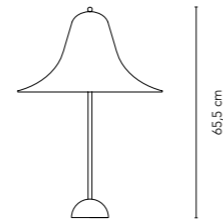

Ø45 cm

FLOOR LAMP

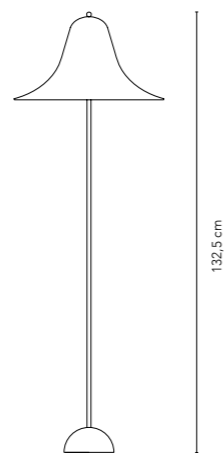

Ø45 cm





Upholstery: Hallingdal 226 / Kvadrat
Ceramics: BO/THYRRESTRUP Design



Upholstery: Hallingdal 126 / Kvadrat



Upholstery: Royal Nubuck Lava 30254 / Sørensen Leather

REFLECT

Table Lamp

by Verner Panton, 1980

WHY WE LOVE IT

Modern design with decorative ambient light
Strong character and presence
Concealed light source

SUGGESTED APPLICATION

Hospitality
Work
Residential

MATERIAL

All parts are made from steel
Powder coated finish
Vertical stem is finished in satin

DIMENSIONS

Shade: Ø30 cm (12")
H: 60 cm (23.6")
Base: Ø 8 cm (3,15")
Weight: 4,2 kg.

COLOURS



VARIANTS

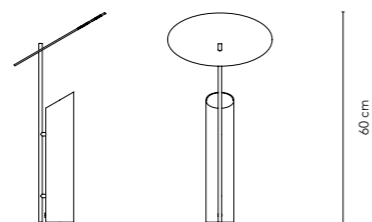



Upholstery: Royal Nubuck Lava 30254 / Sørensen Leather

WIRE

Series

by Verner Panton, 1972

WHY WE LOVE IT

Futuristic design
Generous ambient light
Super versatile

SUGGESTED APPLICATION

Hospitality
Work
Residential

MATERIAL

Frame is made from chrome plated steel
Shade is made from white plastic

DIMENSIONS

TABLE LAMP
H: 54 cm (21.3")
Ø40 cm (15.8")
Weight: 5 kg.

FLOOR LAMP
Diameter: 40 cm (15.8")
Height: 120 cm (47.3")
Weight: 5,5 kg.

SHADE OPTIONS

White

VARIANTS

TABLE LAMP

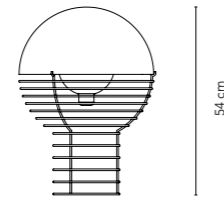

FLOOR LAMP

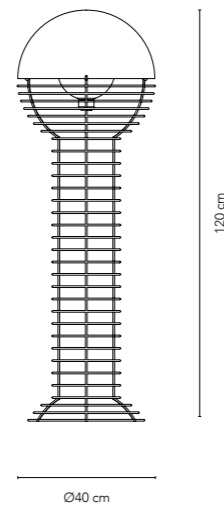



Ceramics: BO/THYRRESTRUP Design



Upholstery: Hallingdal 116 / Kvadrat



Upholstery: Harald 3 283 / Kvadrat

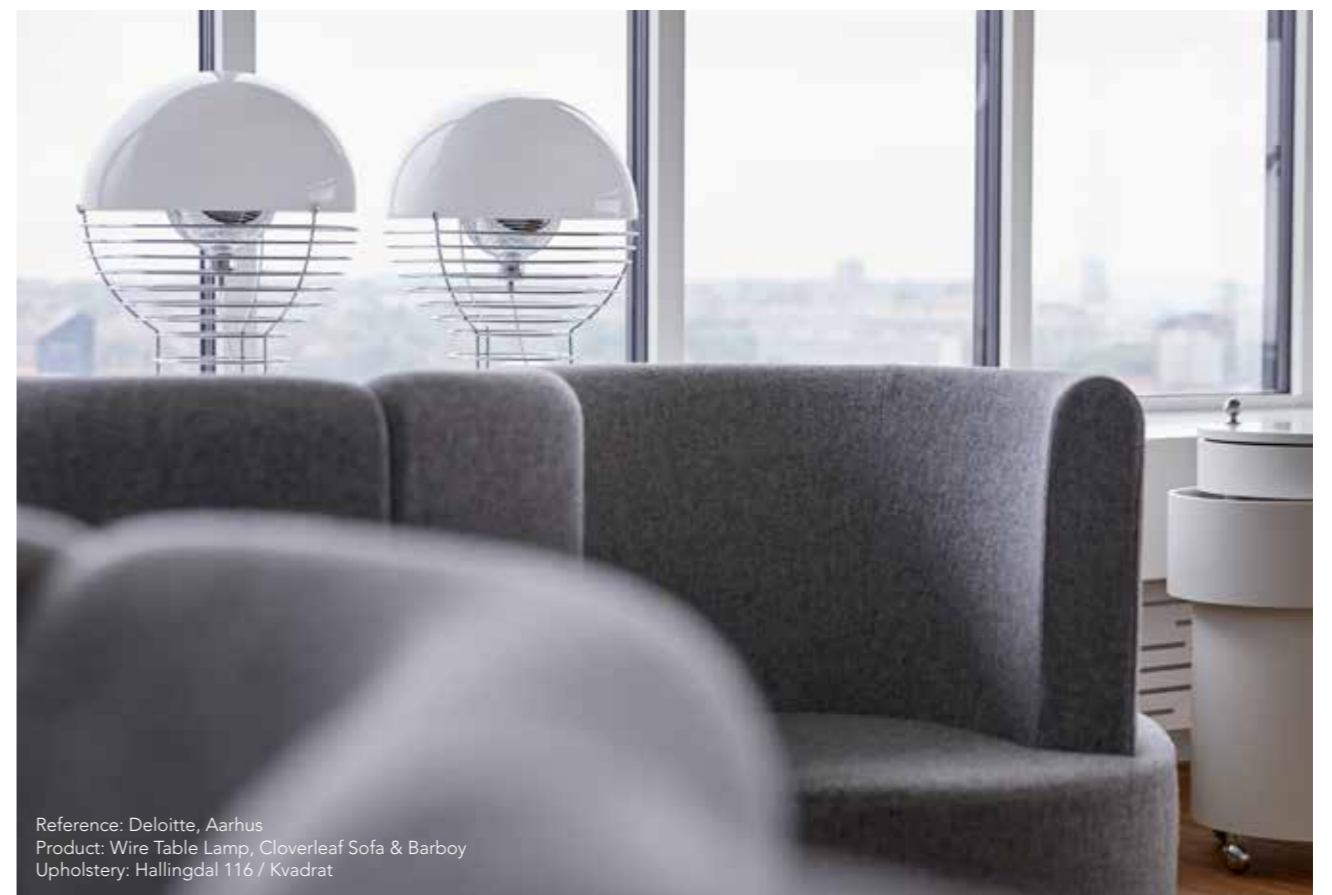

Reference: Deloitte, Aarhus
Product: Wire Table Lamp, Cloverleaf Sofa & Barboj
Upholstery: Hallingdal 116 / Kvadrat

MOON Pendants

by Verner Panton, 1960

WHY WE LOVE IT

One of Panton's earliest lighting designs
Beautiful spherical design
Soft and ambient light output
Great as single piece or in clusters
Available in three sizes

SUGGESTED APPLICATION

Hospitality
Work
Residential

MATERIAL

Lamellae and canopy is made from lacquered metal

DIMENSIONS

SMALL
Ø34 cm (13.4")
Weight: 4,5 kg.

LARGE
Ø44,5 cm (17.5")
Weight: 8 kg.

XXXL
Ø: 150 cm (59.1")
Weight: 125 kg.

SHADE OPTIONS

SMALL

White Orange

LARGE & XXXL

White

VARIANTS

SMALL



Ø34 cm

LARGE



Ø44,5 cm

XXXL

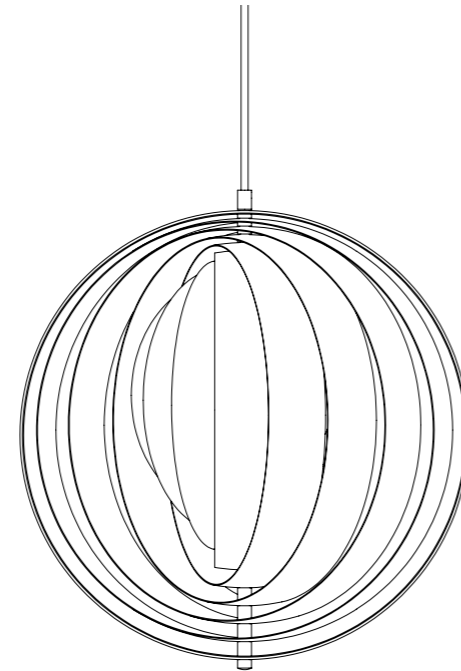

Ø150 cm



FELORE



Reference: Briig Boutique Hotel, Split
Product: Moon Pendant
Photo credit: Nord Klassik



Reference: Skanderborg Kulturhus, Skanderborg
Product: Moon XXXL Pendant



Reference: District Court, Svendborg
Product: Moon XXXL Pendant



Reference: High Court of Western Denmark, Viborg
Product: Moon XXXL Pendant

ONION Pendants

by Verner Panton, 1977

WHY WE LOVE IT

Organic onion shaped design
Soft and ambient light output
Available in two sizes

SUGGESTED APPLICATION

Hospitality
Work
Residential

MATERIAL

Shade and canopy are made of lacquered metal

DIMENSIONS

SMALL/Ø45
H: 69 cm (27.2")
Ø45 cm (17.7")
Weight: 10 kg.

LARGE/Ø65
H: 90 cm (35.6")
Ø65 cm (25.7")
Weight: 22 kg.

SHADE OPTIONS

 White

VARIANTS

SMALL

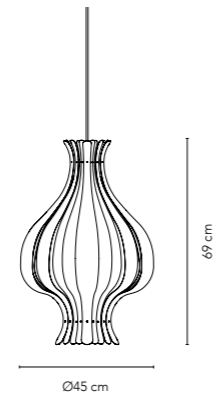

LARGE

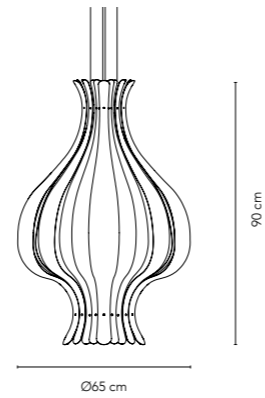

“The main purpose of my work is to provoke people into using their imagination and make their surroundings more exciting.”

- Verner Panton

VERPAN

www.verpan.com